



MBA

2022.4

Sintered Bronze

Plain Bushes - Flanged Bushes - Sheet - Rod - Tube and more



| TYPE | PAGES |
|--------------------|---------|
| Bushes - Flanged | 3-26 |
| Bushes - Plain | 26-102 |
| Bushes - Spherical | 102 |
| Rod | 102-103 |
| Sheet | 103 |
| Tube | 103-106 |
| Washers | 106-109 |

Copy the part number from this catalogue into the search box on any web page for more information, pricing and availability.

Prefixes and Suffixes - For Bushes

B F 0095 - 0127 - 0191 - BS 16 16 LT

1 2 3 4 5 6 7 8 9

1 Bush Designation:

B: Bush

2 Configuration:

F: Flanged
 P: Plain
 SP: Spherical OD (not listed in catalogue)

3 Nominal Inside Dia.

One decimal place indication of nominal inside diameter in mm - eg 0095 = 9.53 ID
 (refer size listing and tolerances for accuracy)

4 Nominal Outside Dia.:

One decimal place indication of nominal outside diameter in mm - eg 0127 = 12.70 OD
 (refer size listing and tolerances for accuracy)

5 Nominal Length:

One decimal place indication of nominal length in mm - eg 0191 = 19.05 Long
 (refer size listing and tolerances for accuracy)

6 Material:

BS: Sintered Bronze SAE841

7 Flange Diameter Indicator:

Indicator of approximate flange diameter to zero decimals. eg, 16 = between 15.5 and 16.5mm.

8 Flange Thickness Indicator:

Indicator of approximate flange thickness to one decimal. eg, 16 = between 1.55 and 1.65mm.

9 Tolerance Indicator:

The following codes represent the tolerance range of the ID (position 1) and the OD (position 2).

- Blank: ID and OD tolerances within standard range
- L: Tolerance is lower than standard
- H: Tolerance is higher than standard
- T: Tolerance is within standard range (Not used in part number if both OD and ID are within standard range)
- U: Diameter is undersized from nominal listed diameter

Standard diametrical tolerances are listed in NOTES towards the back of this catalogue.

Diagrams and Pictures

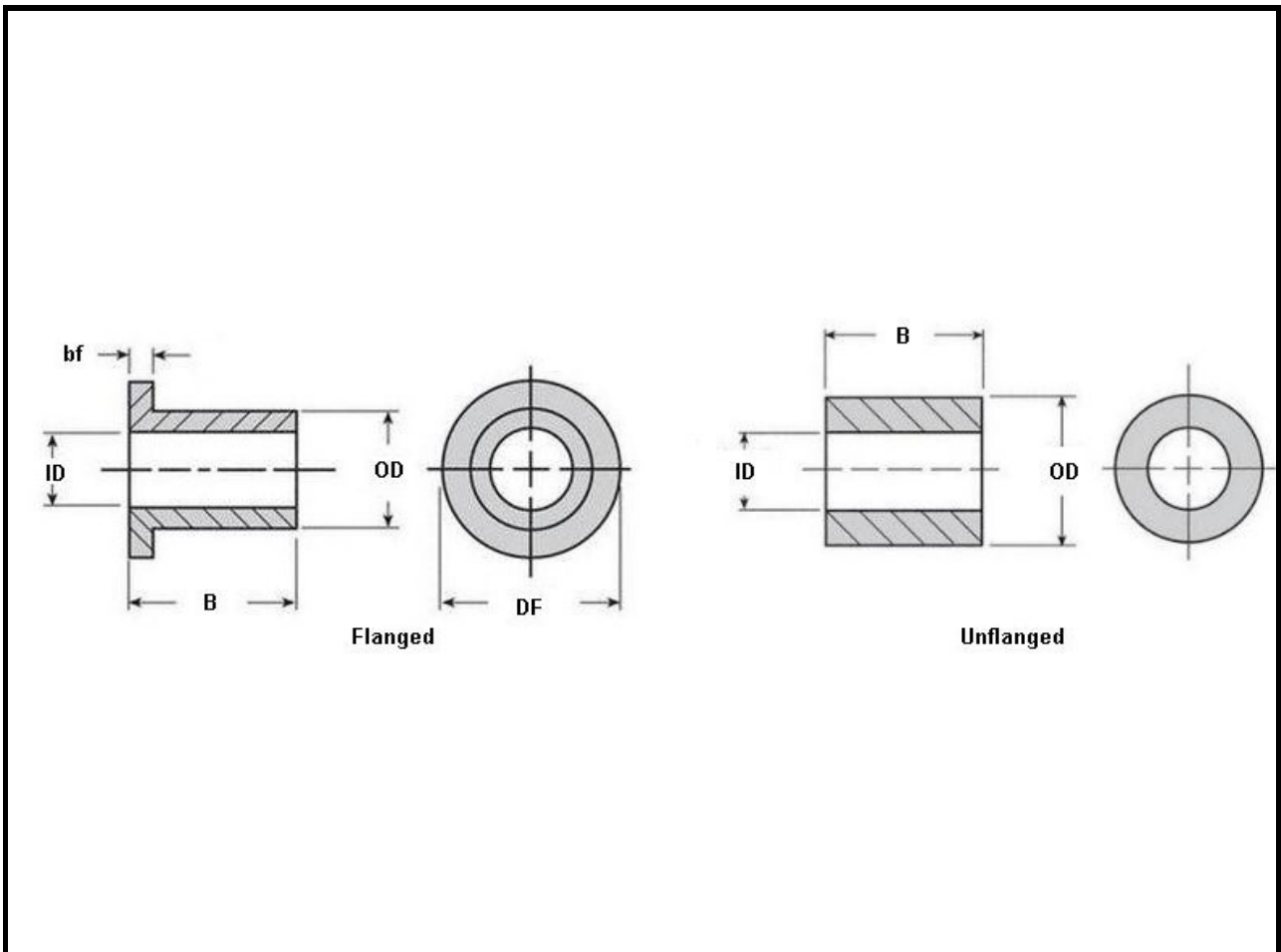

Bushes - Flanged

| Nominal ID (d) mm (inches) | Nominal OD (D) mm | Length (S) mm | Flange OD (D1) mm | Flange Thickness (S1) mm | Part Number |
|--------------------------------------|-------------------------|--------------------|----------------------|-----------------------------|-------------------------------|
| 1.191 (0.047") +0.000/+0.010 (mm) | 3.969 -0.011/+0.001 | 1.588 +0/-0.127 | 5.16 | 0.33 | BF0012-0040-0016-BS0503LU |
| 1.191 (0.047") +0.000/+0.010 (mm) | 3.969 -0.011/+0.001 | 2.380 +0/-0.127 | 5.16 | 0.79 | BF0012-0040-0024-BS0508LU |
| 1.191 (0.047") +0.000/+0.010 (mm) | 4.763 -0.010/+0.003 | 1.984 +0/-0.127 | 5.94 | 0.58 | BF0012-0048-0020-BS0606LU |
| 1.191 (0.047") +0.000/+0.010 (mm) | 4.763 -0.010/+0.003 | 2.779 +0/-0.127 | 5.94 | 0.79 | BF0012-0048-0028-BS0608LU |
| 1.588 (0.063") +0.000/+0.010 (mm) | 4.763 -0.010/+0.003 | 2.779 +0/-0.127 | 5.94 | 0.79 | BF0016-0048-0028-BS0608LU |
| 1.588 (0.063") +0.000/+0.010 (mm) | 6.350 -0.010/+0.003 | 2.380 +0/-0.127 | 7.52 | 0.79 | BF0016-0064-0024-BS0808LU |
| 1.984 (0.078") +0.000/+0.010 (mm) | 6.350 -0.010/+0.003 | 2.380 +0/-0.127 | 7.52 | 0.58 | BF0019-0064-0024-BS0806LU |
| 1.984 (0.078") +0.000/+0.010 (mm) | 6.350 -0.010/+0.003 | 3.571 +0/-0.127 | 7.52 | 0.79 | BF0019-0064-0036-BS0808LU |
| 2.000 (0.079") +0.014/+0.024 (mm) | 4.000 +0.015/+0.027 | 4.000 +0/-0.200 | 6.00 | 1.50 | BF0020-0040-0040-BS0615LL |
| 2.000 (0.079") +0.014/+0.024 (mm) | 5.000 +0.019/+0.031 | 3.000 +/-0.127 | 8.00 | 1.50 | BF0020-0050-0030-BS0815LL |
| 2.381 (0.094") +0.000/+0.010 (mm) | 4.763 -0.010/+0.003 | 1.588 +0/-0.127 | 5.94 | 0.46 | BF0024-0048-0016-BS0605LU |
| 2.381 (0.094") +0.000/+0.010 (mm) | 4.763 -0.010/+0.003 | 2.380 +0/-0.127 | 5.94 | 0.79 | BF0024-0048-0024-BS0608LU |
| 2.381 (0.094") +0.000/+0.010 (mm) | 7.938 -0.010/+0.003 | 2.779 +0/-0.127 | 9.12 | 0.58 | BF0024-0079-0028-BS0906LU |
| 2.381 (0.094") +0.000/+0.010 (mm) | 7.938 -0.010/+0.003 | 2.779 +0/-0.127 | 9.12 | 0.79 | BF0024-0079-0028-BS0908LU |
| 2.381 (0.094") +0.000/+0.010 (mm) | 7.938 -0.010/+0.003 | 3.571 +0/-0.127 | 9.12 | 0.79 | BF0024-0079-0036-BS0908LU |
| 2.500 (0.098") +0.014/+0.024 (mm) | 6.000 +0.021/+0.046 | 3.000 +/-0.127 | 9.00 | 1.50 | BF0025-0060-0030-BS0915LT |
| 3.000 (0.118") +0.014/+0.024 (mm) | 5.000 +0.019/+0.040 | 4.000 +0/-0.200 | 8.00 | 1.50 | BF0030-0050-0040-BS0815LL |
| 3.000 (0.118") +0.000/+0.010 (mm) | 6.000 -0.008/+0.000 | 2.500 +0/-0.170 | 8.00 | 0.50 | BF0030-0060-0025-BS0805LU |
| 3.000 (0.118") +0.000/+0.020 (mm) | 6.000 +0.019/+0.040 | 4.000 +/-0.127 | 9.00 | 1.50 | BF0030-0060-0040-BS0915LT |
| 3.000 (0.118") +0.000/+0.020 (mm) | 6.000 +0.019/+0.040 | 6.000 +/-0.120 | 9.00 | 1.50 | BF0030-0060-0060-BS0915LT |
| 3.000 (0.118") +0.000/+0.020 (mm) | 6.000 +0.019/+0.040 | 10.000 +/-0.120 | 9.00 | 1.50 | BF0030-0060-0100-BS0915LT |
| 3.000 (0.118") +0.000/+0.010 (mm) | 8.000 -0.008/+0.000 | 3.000 +0/-0.170 | 10.00 | 0.50 | BF0030-0080-0030-BS1005LU |
| 3.000 (0.118") +0.000/+0.010 (mm) | 10.000 -0.009/+0.000 | 4.000 +0/-0.170 | 12.00 | 1.00 | BF0030-0100-0040-BS1210LU |
| 3.175 (0.125") +0.000/+0.025 (mm) | 4.763 +0.038/+0.063 | 5.791 +0/-0.305 | 6.35 | 0.89 | BF0032-0048-0058-BS0609LH |
| 3.175 (0.125") -0.013/+0.013 (mm) | 5.556 +0.045/+0.070 | 3.100 -0.178/+0 | 8.64 | 1.27 | BF0032-0056-0031-BS0913UH |
| 3.175 (0.125") +0.025/+0.051 (mm) | 5.556 +0.045/+0.070 | 3.759 -0.178/+0 | 8.76 | 1.55 | BF0032-0056-0038-BS0916TH |
| 3.175 (0.125") +0.000/+0.010 (mm) | 6.350 -0.010/+0.003 | 2.380 +0/-0.127 | 7.52 | 0.58 | BF0032-0064-0024-BS0806LU |
| 3.175 (0.125") +0.000/+0.010 (mm) | 6.350 -0.010/+0.003 | 2.779 +0/-0.127 | 7.52 | 0.79 | BF0032-0064-0028-BS0808LU |
| 3.175 (0.125") +0.025/+0.051 (mm) | 6.350 +0.025/+0.051 | 3.175 +/-0.127 | 9.14 | 1.19 | BF0032-0064-0032-BS0912TT |
| 3.175 (0.125") +0.000/+0.025 (mm) | 6.350 +0.025/+0.051 | 6.350 +0/-0.127 | 7.930 | 1.59 | BF0032-0064-0064-BS0816LT |
| 3.175 (0.125") +0.025/+0.051 (mm) | 6.350 +0.025/+0.051 | 6.350 +/-0.127 | 9.14 | 1.19 | BF0032-0064-0064-BS09120912TT |
| 3.175 (0.125") +0.000/+0.025 (mm) | 6.350 +0.025/+0.051 | 9.525 +0/-0.127 | 7.930 | 1.59 | BF0032-0064-0095-BS0816LT |
| 3.175 (0.125") +0.025/+0.051 (mm) | 6.350 +0.025/+0.051 | 9.525 +/-0.127 | 9.14 | 1.19 | BF0032-0064-0095-BS09120912TT |

Stocked or Short Delivery

Usually Available Short Delivery

Long delivery or not in current production

* Large Minimum Quantities

** Available only while stock lasts

Bushes - Flanged

| Nominal ID (d) mm (inches) | Nominal OD (D) mm | Length (S) mm | Flange OD (D1) mm | Flange Thickness (S1) mm | Part Number |
|--------------------------------------|------------------------|--------------------|----------------------|-----------------------------|---------------------------|
| 3.175 (0.125") +0.000/+0.010 (mm) | 7.938 -0.010/+0.003 | 2.779 +0/-0.127 | 9.12 | 0.58 | BF0032-0079-0028-BS0906LU |
| 3.175 (0.125") +0.000/+0.010 (mm) | 7.938 -0.010/+0.003 | 3.571 +0/-0.127 | 9.12 | 0.79 | BF0032-0079-0036-BS0908LU |
| 3.175 (0.125") +0.025/+0.051 (mm) | 7.938 +0.038/+0.064 | 6.350 | 9.530 | 1.19 | BF0032-0079-0064-BS1012TH |
| 3.175 (0.125") +0.025/+0.051 (mm) | 7.938 +0.038/+0.064 | 9.525 | 9.530 | 1.19 | BF0032-0079-0095-BS1012TH |
| 3.175 (0.125") +0.000/+0.010 (mm) | 9.525 -0.010/+0.003 | 2.779 +0/-0.127 | 10.72 | 0.58 | BF0032-0095-0028-BS1106LU |
| 3.175 (0.125") +0.000/+0.010 (mm) | 9.525 -0.010/+0.003 | 3.571 +0/-0.127 | 10.72 | 0.79 | BF0032-0095-0036-BS1108LU |
| 3.969 (0.156") +0.000/+0.010 (mm) | 7.938 -0.010/+0.003 | 2.779 +0/-0.127 | 9.12 | 0.58 | BF0039-0079-0028-BS0906LU |
| 3.969 (0.156") +0.000/+0.010 (mm) | 7.938 -0.010/+0.003 | 3.175 +0/-0.127 | 9.12 | 0.91 | BF0039-0079-0032-BS0909LU |
| 4.000 (0.157") +0.000/+0.020 (mm) | 7.000 +0.019/+0.040 | 6.000 +/-0.120 | 12.00 | 2.00 | BF0040-0070-0060-BS1220LT |
| 4.000 (0.157") +0.000/+0.020 (mm) | 7.000 +0.019/+0.040 | 10.000 +/-0.120 | 12.00 | 2.00 | BF0040-0070-0100-BS1220LT |
| 4.000 (0.157") +0.000/+0.012 (mm) | 8.000 -0.008/+0.000 | 4.000 +0/-0.170 | 10.00 | 1.00 | BF0040-0080-0040-BS1010LU |
| 4.000 (0.157") +0.000/+0.020 (mm) | 8.000 +0.019/+0.040 | 4.000 +/-0.127 | 12.00 | 2.00 | BF0040-0080-0040-BS1220LT |
| 4.000 (0.157") +0.020/+0.032 (mm) | 8.000 +0.019/+0.034 | 6.000 +0/-0.200 | 10.00 | 1.50 | BF0040-0080-0060-BS1015TL |
| 4.000 (0.157") +0.000/+0.020 (mm) | 8.000 +0.019/+0.040 | 6.000 +/-0.127 | 12.00 | 2.00 | BF0040-0080-0060-BS1220LT |
| 4.000 (0.157") +0.000/+0.020 (mm) | 8.000 +0.019/+0.040 | 8.000 +/-0.127 | 12.00 | 2.00 | BF0040-0080-0080-BS1220LT |
| 4.000 (0.157") +0.000/+0.020 (mm) | 8.000 +0.019/+0.040 | 12.000 +/-0.127 | 12.00 | 2.00 | BF0040-0080-0120-BS1220LT |
| 4.763 (0.188") +0.012/+0.038 (mm) | 6.350 +0.051/+0.076 | 8.865 +0/-0.127 | 7.87 | 0.86 | BF0048-0064-0089-BS0809LH |
| 4.763 (0.188") +0.000/+0.025 (mm) | 7.144 +0.045/+0.070 | 5.537 +0/-0.152 | 96.14 | 1.45 | BF0048-0071-0055-BS9615LH |
| 4.763 (0.188") +0.012/+0.038 (mm) | 7.144 +0.051/+0.076 | 7.137 +/-0.127 | 9.53 | 3.07 | BF0048-0071-0071-BS1031LH |
| 4.763 (0.188") +0.012/+0.038 (mm) | 7.938 +0.025/+0.051 | 3.175 +/-0.191 | 9.53 | 1.19 | BF0048-0079-0032-BS1012LT |
| 4.763 (0.188") +0.000/+0.025 (mm) | 7.938 +0.051/+0.076 | 3.416 -0.178/+0 | 11.11 | 1.57 | BF0048-0079-0034-BS1116LH |
| 4.763 (0.188") +0.025/+0.051 (mm) | 7.938 +0.012/+0.038 | 4.763 +/-0.127 | 11.11 | 1.59 | BF0048-0079-0048-BS1116TL |
| 4.763 (0.188") +0.025/+0.051 (mm) | 7.938 +0.051/+0.076 | 4.763 +/-0.127 | 11.11 | 1.59 | BF0048-0079-0048-BS1116TH |
| 4.763 (0.188") +0.012/+0.038 (mm) | 7.938 +0.051/+0.076 | 6.096 +0/-0.152 | 9.53 | 2.21 | BF0048-0079-0061-BS1022LH |
| 4.763 (0.188") +0.025/+0.051 (mm) | 7.938 +0.012/+0.038 | 6.350 +/-0.127 | 11.11 | 1.59 | BF0048-0079-0064-BS1116TL |
| 4.763 (0.188") +0.025/+0.051 (mm) | 7.938 +0.051/+0.076 | 6.350 +/-0.127 | 11.11 | 1.59 | BF0048-0079-0064-BS1116TH |
| 4.763 (0.188") +0.025/+0.051 (mm) | 7.938 +0.025/+0.051 | 6.350 +/-0.127 | 9.40 | 1.19 | BF0048-0079-0064-BS0912TT |
| 4.763 (0.188") +0.012/+0.038 (mm) | 7.938 +0.025/+0.051 | 6.350 +/-0.191 | 9.53 | 1.19 | BF0048-0079-0064-BS1012LT |
| 4.763 (0.188") +0.025/+0.051 (mm) | 7.938 +0.023/+0.038 | 6.350 +/-0.127 | 9.53 | 1.58 | BF0048-0079-0064-BS1016TL |
| 4.763 (0.188") -0.038/-0.013 (mm) | 7.938 -0.013/+0.012 | 6.350 +/-0.127 | 9.53 | 1.59 | BF0048-0079-0064-BS1016UU |
| 4.763 (0.188") +0.025/+0.051 (mm) | 7.938 +0.012/+0.038 | 7.938 +/-0.127 | 11.11 | 1.59 | BF0048-0079-0079-BS1116TL |
| 4.763 (0.188") +0.025/+0.051 (mm) | 7.938 +0.051/+0.076 | 7.938 +/-0.127 | 11.11 | 1.59 | BF0048-0079-0079-BS1116TH |
| 4.763 (0.188") +0.025/+0.051 (mm) | 7.938 +0.012/+0.038 | 9.525 +/-0.127 | 11.11 | 1.59 | BF0048-0079-0095-BS1116TL |

Stocked or Short Delivery

Usually Available Short Delivery

Long delivery or not in current production

* Large Minimum Quantities

** Available only while stock lasts

Page 4 of 111

E&OE

Bushes - Flanged

| Nominal ID (d) mm (inches) | Nominal OD (D) mm | Length (S) mm | Flange OD (D1) mm | Flange Thickness (S1) mm | Part Number |
|--------------------------------------|-------------------------|--------------------|----------------------|-----------------------------|-----------------------------|
| 4.763 (0.188") +0.025/+0.051 (mm) | 7.938 +0.051/+0.076 | 9.525 +/-0.127 | 11.11 | 1.59 | BF0048-0079-0095-BS1116TH |
| 4.763 (0.188") +0.025/+0.051 (mm) | 7.938 +0.025/+0.051 | 9.525 +/-0.127 | 9.40 | 1.19 | BF0048-0079-0095-BS0912TT |
| 4.763 (0.188") +0.012/+0.038 (mm) | 7.938 +0.025/+0.051 | 9.525 +/-0.127 | 9.53 | 1.19 | BF0048-0079-0095-BS1012LT |
| 4.763 (0.188") +0.025/+0.051 (mm) | 7.938 +0.023/+0.038 | 9.525 +/-0.127 | 9.53 | 1.58 | * BF0048-0079-0095-BS1016TL |
| 4.763 (0.188") -0.038/-0.013 (mm) | 7.938 -0.013/+0.012 | 9.525 +/-0.127 | 9.53 | 1.59 | BF0048-0079-0095-BS1016UU |
| 4.763 (0.188") +0.025/+0.051 (mm) | 7.938 +0.051/+0.076 | 12.700 +/-0.127 | 11.11 | 1.59 | BF0048-0079-0127-BS1116TH |
| 4.763 (0.188") +0.025/+0.051 (mm) | 7.938 +0.013/+0.038 | 12.700 | 11.110 | 1.59 | BF0048-0079-0127-BS1116TL |
| 4.763 (0.188") +0.025/+0.051 (mm) | 7.938 +0.025/+0.051 | 12.700 +/-0.127 | 9.40 | 1.19 | BF0048-0079-0127-BS0912TT |
| 4.763 (0.188") +0.025/+0.051 (mm) | 7.938 +0.023/+0.038 | 12.700 +/-0.127 | 9.53 | 1.58 | BF0048-0079-0127-BS1016TL |
| 4.763 (0.188") +0.025/+0.051 (mm) | 7.938 +0.025/+0.051 | 15.875 +/-0.127 | 9.40 | 1.19 | BF0048-0079-0159-BS0912TT |
| 4.763 (0.188") +0.000/+0.010 (mm) | 9.525 -0.010/+0.003 | 2.779 +0/-0.127 | 10.72 | 0.58 | BF0048-0095-0028-BS1106LU |
| 4.763 (0.188") +0.000/+0.010 (mm) | 9.525 -0.010/+0.003 | 3.175 +0/-0.127 | 10.72 | 0.58 | BF0048-0095-0032-BS1106LU |
| 4.763 (0.188") +0.000/+0.010 (mm) | 9.525 -0.010/+0.003 | 3.175 +0/-0.127 | 10.72 | 0.79 | BF0048-0095-0032-BS1108LU |
| 4.763 (0.188") +0.025/+0.051 (mm) | 9.525 +0.012/+0.038 | 9.525 +/-0.127 | 11.11 | 1.59 | BF0048-0095-0095-BS1116TL |
| 4.763 (0.188") +0.025/+0.051 (mm) | 9.525 +0.012/+0.038 | 12.700 +/-0.127 | 11.11 | 1.59 | BF0048-0095-0127-BS1116TL |
| 4.763 (0.188") +0.000/+0.010 (mm) | 12.700 -0.010/+0.003 | 3.967 +0/-0.127 | 14.35 | 1.07 | BF0048-0127-0040-BS1411LU |
| 4.763 (0.188") +0.000/+0.010 (mm) | 12.700 -0.010/+0.003 | 4.978 +0/-0.127 | 14.35 | 1.07 | BF0048-0127-0050-BS1411LU |
| 5.000 (0.197") +0.000/+0.020 (mm) | 8.000 +0.019/+0.040 | 5.000 +/-0.120 | 12.00 | 2.00 | BF0050-0080-0050-BS1220LT |
| 5.000 (0.197") +0.020/+0.032 (mm) | 8.000 +0.019/+0.034 | 6.000 +0/-0.200 | 10.00 | 2.00 | BF0050-0080-0060-BS1020TL |
| 5.000 (0.197") +0.000/+0.020 (mm) | 8.000 +0.019/+0.040 | 6.000 +/-0.120 | 12.00 | 2.00 | BF0050-0080-0060-BS1220LT |
| 5.000 (0.197") +0.020/+0.032 (mm) | 9.000 +0.023/+0.038 | 4.000 +/-0.127 | 13.00 | 2.00 | BF0050-0090-0040-BS1320LT |
| 5.000 (0.197") +0.020/+0.032 (mm) | 9.000 +0.023/+0.038 | 5.000 +/-0.127 | 13.00 | 2.00 | BF0050-0090-0050-BS1320LT |
| 5.000 (0.197") +0.020/+0.032 (mm) | 9.000 +0.023/+0.038 | 8.000 +/-0.127 | 13.00 | 2.00 | BF0050-0090-0080-BS1320LT |
| 5.000 (0.197") +0.000/+0.012 (mm) | 10.000 -0.009/+0.000 | 5.000 +0/-0.170 | 12.00 | 1.00 | BF0050-0100-0050-BS1210LU |
| 5.000 (0.197") +0.020/+0.032 (mm) | 10.000 +0.019/+0.034 | 6.000 +0/-0.200 | 12.00 | 2.00 | BF0050-0100-0060-BS1220TL |
| 5.000 (0.197") +0.000/+0.012 (mm) | 12.000 -0.011/+0.000 | 4.000 +0/-0.170 | 14.00 | 1.00 | BF0050-0120-0040-BS1410LU |
| 5.000 (0.197") +0.000/+0.012 (mm) | 13.000 -0.011/+0.000 | 5.000 +0/-0.170 | 14.00 | 1.00 | BF0050-0130-0050-BS1410LU |
| 5.556 (0.219") -0.019/+0.006 (mm) | 7.144 +0.006/+0.032 | 5.258 +0/-0.127 | 7.87 | 2.13 | BF0056-0071-0053-BS0821UL |
| 6.000 (0.236") +0.000/+0.020 (mm) | 9.000 +0.019/+0.040 | 5.000 +/-0.120 | 14.00 | 1.50 | BF0060-0090-0050-BS1415LT |
| 6.000 (0.236") +0.000/+0.020 (mm) | 9.000 +0.019/+0.040 | 6.000 +/-0.120 | 12.00 | 1.50 | BF0060-0090-0060-BS1215LT |
| 6.000 (0.236") +0.005/+0.030 (mm) | 9.000 +0.019/+0.040 | 10.000 +/-0.127 | 12.00 | 1.50 | BF0060-0090-0100-BS1215LT |
| 6.000 (0.236") +0.000/+0.020 (mm) | 9.000 +0.019/+0.040 | 12.000 +/-0.120 | 12.00 | 1.50 | BF0060-0090-0120-BS1215LT |
| 6.000 (0.236") +0.000/+0.025 (mm) | 10.000 +0.025/+0.051 | 4.000 +/-0.127 | 14.00 | 2.00 | BF0060-0100-0040-BS1420LT |

 Stocked or Short Delivery

 Usually Available Short Delivery

 Long delivery or not in current production

* Large Minimum Quantities

** Available only while stock lasts

Bushes - Flanged

| Nominal ID (d) mm (inches) | Nominal OD (D) mm | Length (S) mm | Flange OD (D1) mm | Flange Thickness (S1) mm | Part Number |
|--------------------------------------|-------------------------|--------------------|----------------------|-----------------------------|---------------------------|
| 6.000 (0.236") +0.000/+0.012 (mm) | 10.000 -0.009/+0.000 | 5.000 +0/-0.170 | 12.00 | 1.00 | BF0060-0100-0050-BS1210LU |
| 6.000 (0.236") +0.005/+0.030 (mm) | 10.000 +0.019/+0.040 | 6.000 +0/-0.200 | 14.00 | 2.00 | BF0060-0100-0060-BS1420TL |
| 6.000 (0.236") +0.000/+0.020 (mm) | 10.000 +0.019/+0.040 | 10.000 +/-0.127 | 14.00 | 2.00 | BF0060-0100-0100-BS1420LT |
| 6.000 (0.236") +0.000/+0.020 (mm) | 10.000 +0.019/+0.040 | 14.000 +/-0.120 | 14.00 | 2.00 | BF0060-0100-0140-BS1420LT |
| 6.000 (0.236") +0.000/+0.020 (mm) | 10.000 +0.019/+0.040 | 16.000 +/-0.120 | 14.00 | 2.00 | BF0060-0100-0160-BS1420LT |
| 6.000 (0.236") +0.020/+0.032 (mm) | 12.000 +0.023/+0.041 | 6.000 +0/-0.200 | 14.00 | 2.00 | BF0060-0120-0060-BS1420LT |
| 6.000 (0.236") +0.000/+0.012 (mm) | 16.000 -0.010/+0.003 | 5.000 +0/-0.170 | 18.00 | 1.00 | BF0060-0160-0050-BS1810LU |
| 6.350 (0.250") +0.025/+0.051 (mm) | 7.938 +0.063/+0.089 | 3.962 +/-0.127 | 11.11 | 1.65 | BF0064-0079-0040-BS1117TH |
| 6.350 (0.250") +0.025/+0.051 (mm) | 7.938 +0.063/+0.089 | 6.350 +/-0.127 | 11.11 | 1.65 | BF0064-0079-0064-BS1117TH |
| 6.350 (0.250") +0.025/+0.051 (mm) | 7.938 +0.051/+0.076 | 12.700 +/-0.127 | 11.11 | 1.68 | BF0064-0079-0127-BS1117TH |
| 6.350 (0.250") +0.000/+0.010 (mm) | 9.525 -0.010/+0.003 | 3.175 +0/-0.127 | 10.72 | 0.58 | BF0064-0095-0032-BS1106LU |
| 6.350 (0.250") +0.000/+0.010 (mm) | 9.525 -0.010/+0.003 | 3.175 +0/-0.127 | 10.72 | 0.91 | BF0064-0095-0032-BS1109LU |
| 6.350 (0.250") +0.025/+0.051 (mm) | 9.525 +0.038/+0.064 | 4.763 +/-0.127 | 11.91 | 1.59 | BF0064-0095-0048-BS1216TH |
| 6.350 (0.250") +0.025/+0.051 (mm) | 9.525 +0.051/+0.076 | 4.763 +/-0.127 | 12.70 | 1.59 | BF0064-0095-0048-BS1316TH |
| 6.350 (0.250") -0.025/+0.000 (mm) | 9.525 +0.127/+0.152 | 4.763 +/-0.127 | 12.70 | 1.59 | BF0064-0095-0048-BS1316UH |
| 6.350 (0.250") +0.025/+0.051 (mm) | 9.525 +0.038/+0.063 | 6.350 +/-0.127 | 11.91 | 1.59 | BF0064-0095-0064-BS1216TH |
| 6.350 (0.250") +0.025/+0.051 (mm) | 9.525 +0.025/+0.051 | 6.350 +/-0.191 | 12.70 | 1.19 | BF0064-0095-0064-BS1312TT |
| 6.350 (0.250") +0.025/+0.051 (mm) | 9.525 +0.051/+0.076 | 6.350 +/-0.127 | 12.70 | 1.59 | BF0064-0095-0064-BS1316TH |
| 6.350 (0.250") -0.025/+0.000 (mm) | 9.525 +0.127/+0.152 | 6.350 +/-0.127 | 12.70 | 1.59 | BF0064-0095-0064-BS1316UH |
| 6.350 (0.250") +0.025/+0.051 (mm) | 9.525 +0.038/+0.064 | 7.938 +/-0.127 | 11.91 | 1.59 | BF0064-0095-0079-BS1216TH |
| 6.350 (0.250") -0.025/+0.000 (mm) | 9.525 +0.127/+0.152 | 7.938 +/-0.127 | 12.70 | 1.59 | BF0064-0095-0079-BS1316UH |
| 6.350 (0.250") +0.025/+0.051 (mm) | 9.525 +0.038/+0.063 | 9.525 +/-0.127 | 11.91 | 1.19 | BF0064-0095-0095-BS1212TH |
| 6.350 (0.250") +0.025/+0.051 (mm) | 9.525 +0.038/+0.063 | 9.525 +/-0.127 | 11.91 | 1.59 | BF0064-0095-0095-BS1216TH |
| 6.350 (0.250") +0.025/+0.051 (mm) | 9.525 +0.025/+0.051 | 9.525 +/-0.191 | 12.70 | 1.19 | BF0064-0095-0095-BS1312TT |
| 6.350 (0.250") +0.025/+0.051 (mm) | 9.525 +0.023/+0.038 | 9.525 +/-0.127 | 12.70 | 1.58 | BF0064-0095-0095-BS1316TL |
| 6.350 (0.250") +0.025/+0.051 (mm) | 9.525 +0.051/+0.076 | 9.525 +/-0.127 | 12.70 | 1.59 | BF0064-0095-0095-BS1316TH |
| 6.350 (0.250") -0.025/+0.000 (mm) | 9.525 +0.127/+0.152 | 9.525 +/-0.127 | 12.70 | 1.59 | BF0064-0095-0095-BS1316UH |
| 6.350 (0.250") +0.025/+0.051 (mm) | 9.525 +0.076/+0.102 | 10.312 +/-0.127 | 12.70 | 2.41 | BF0064-0095-0103-BS1324TH |
| 6.350 (0.250") +0.025/+0.051 (mm) | 9.525 +0.038/+0.064 | 11.113 +/-0.127 | 11.91 | 1.59 | BF0064-0095-0111-BS1216TH |
| 6.350 (0.250") +0.025/+0.051 (mm) | 9.525 +0.051/+0.076 | 11.113 +/-0.127 | 12.70 | 1.59 | BF0064-0095-0111-BS1316TH |
| 6.350 (0.250") -0.025/+0.000 (mm) | 9.525 +0.127/+0.152 | 11.113 +/-0.127 | 12.70 | 1.59 | BF0064-0095-0111-BS1316UH |
| 6.350 (0.250") +0.025/+0.051 (mm) | 9.525 +0.038/+0.063 | 12.700 +/-0.127 | 11.91 | 1.59 | BF0064-0095-0127-BS1216TH |
| 6.350 (0.250") +0.025/+0.051 (mm) | 9.525 +0.025/+0.051 | 12.700 +/-0.191 | 12.70 | 1.19 | BF0064-0095-0127-BS1312TT |
| 6.350 (0.250") +0.025/+0.051 (mm) | 9.525 +0.023/+0.038 | 12.700 +/-0.127 | 12.70 | 1.58 | BF0064-0095-0127-BS1316TL |

Stocked or Short Delivery
 Usually Available Short Delivery
 Long delivery or not in current production

* Large Minimum Quantities

** Available only while stock lasts

Bushes - Flanged

| Nominal ID (d) mm (inches) | Nominal OD (D) mm | Length (S) mm | Flange OD (D1) mm | Flange Thickness (S1) mm | Part Number |
|--------------------------------------|-------------------------|---------------------|----------------------|-----------------------------|----------------------------------|
| 6.350 (0.250") +0.025/+0.051 (mm) | 9.525 +0.051/+0.076 | 12.700 +/-0.127 | 12.70 | 1.59 | BF0064-0095-0127-BS1316TH |
| 6.350 (0.250") +0.051/+0.076 (mm) | 9.525 +0.025/+0.051 | 12.700 +/-0.127 | 12.70 | 1.59 | BF0064-0095-0127-BS1316HT |
| 6.350 (0.250") -0.025/+0.000 (mm) | 9.525 +0.127/+0.152 | 12.700 +/-0.127 | 12.70 | 1.59 | BF0064-0095-0127-BS1316UH |
| 6.350 (0.250") -0.025/+0.000 (mm) | 9.525 +0.127/+0.152 | 14.288 +/-0.127 | 12.70 | 1.59 | BF0064-0095-0143-BS1316UH |
| 6.350 (0.250") +0.025/+0.051 (mm) | 9.525 +0.076/+0.102 | 14.681 +0/-0.127 | 12.70 | 2.41 | BF0064-0095-0147-BS1324TH |
| 6.350 (0.250") +0.025/+0.051 (mm) | 9.525 +0.038/+0.064 | 15.875 +/-0.127 | 11.91 | 1.59 | BF0064-0095-0159-BS1216TH |
| 6.350 (0.250") +0.025/+0.051 (mm) | 9.525 +0.025/+0.051 | 15.875 +/-0.191 | 12.70 | 1.19 | BF0064-0095-0159-BS1312TT |
| 6.350 (0.250") +0.025/+0.051 (mm) | 9.525 +0.051/+0.076 | 15.875 +/-0.127 | 12.70 | 1.59 | BF0064-0095-0159-BS1316TH |
| 6.350 (0.250") -0.025/+0.000 (mm) | 9.525 +0.127/+0.152 | 17.463 +/-0.127 | 12.70 | 1.59 | BF0064-0095-0175-BS1316UH |
| 6.350 (0.250") +0.025/+0.051 (mm) | 9.525 +0.038/+0.064 | 19.050 +/-0.127 | 11.91 | 1.59 | BF0064-0095-0191-BS1216TH |
| 6.350 (0.250") +0.025/+0.051 (mm) | 9.525 +0.025/+0.051 | 19.050 +/-0.191 | 12.70 | 1.19 | BF0064-0095-0191-BS1312TT |
| 6.350 (0.250") +0.025/+0.051 (mm) | 9.525 +0.023/+0.038 | 19.050 +/-0.127 | 12.70 | 1.58 | BF0064-0095-0191-BS1316TL |
| 6.350 (0.250") +0.025/+0.051 (mm) | 9.525 +0.051/+0.076 | 19.050 +/-0.127 | 12.70 | 1.59 | BF0064-0095-0191-BS1316TH |
| 6.350 (0.250") +0.000/+0.025 (mm) | 11.113 +0.025/+0.051 | 12.700 +/-0.127 | 12.70 | 1.59 | BF0064-0111-0127-BS1316LT |
| 6.350 (0.250") +0.000/+0.010 (mm) | 12.700 -0.010/+0.003 | 3.175 +0/-0.127 | 13.89 | 0.58 | BF0064-0127-0032-BS1406LU |
| 6.350 (0.250") +0.000/+0.010 (mm) | 12.700 -0.010/+0.003 | 4.763 +0/-0.127 | 13.89 | 1.14 | BF0064-0127-0048-BS1411LU |
| 6.350 (0.250") +0.025/+0.051 (mm) | 12.700 +0.051/+0.076 | 15.875 +/-0.127 | 15.88 | 1.59 | BF0064-0127-0159-BS1616TH |
| 6.350 (0.250") +0.025/+0.051 (mm) | 12.700 +0.051/+0.076 | 19.050 +/-0.127 | 15.88 | 1.59 | BF0064-0127-0191-BS1616TH |
| 6.350 (0.250") +0.000/+0.010 (mm) | 15.875 -0.010/+0.003 | 4.978 +0/-0.127 | 17.53 | 1.07 | BF0064-0159-0050-BS1811LU |
| 7.000 (0.276") +0.005/+0.030 (mm) | 11.000 +0.028/+0.050 | 8.000 +/-0.127 | 15.00 | 2.00 | BF0070-0110-0080-BS1520LT |
| 7.000 (0.276") +0.025/+0.040 (mm) | 12.000 +0.023/+0.041 | 8.000 +0/-0.200 | 16.00 | 3.00 | BF0070-0120-0080-BS1630TT |
| 7.144 (0.281") +0.000/+0.025 (mm) | 9.525 +0.076/+0.102 | 5.558 +/-0.127 | 12.70 | 2.41 | BF0071-0095-0056-BS1324LH |
| 7.938 (0.313") +0.012/+0.038 (mm) | 9.525 +0.025/+0.051 | 9.525 +/-0.191 | 12.70 | 1.19 | BF0079-0095-0095-BS1312LT |
| 7.938 (0.313") +0.025/+0.051 (mm) | 11.113 +0.051/+0.076 | 9.525 +/-0.127 | 14.29 | 1.59 | BF0079-0111-0095-BS1416TH |
| 7.938 (0.313") +0.038/+0.064 (mm) | 11.113 +0.038/+0.064 | 9.525 +/-0.127 | 14.29 | 1.59 | BF0079-0111-0095-BS1416HH |
| 7.938 (0.313") -0.025/+0.000 (mm) | 11.113 +0.038/+0.063 | 9.525 +/-0.127 | 14.29 | 1.59 | BF0079-0111-0095-BS1416UH |
| 7.938 (0.313") +0.012/+0.038 (mm) | 11.113 +0.012/+0.038 | 9.525 +/-0.191 | 15.88 | 2.38 | BF0079-0111-0095-BS1624LL |
| 7.938 (0.313") +0.025/+0.051 (mm) | 11.113 +0.051/+0.076 | 12.700 +/-0.127 | 14.29 | 1.59 | BF0079-0111-0127-BS1416TH |
| 7.938 (0.313") +0.038/+0.064 (mm) | 11.113 +0.038/+0.064 | 12.700 +/-0.127 | 14.29 | 1.59 | BF0079-0111-0127-BS1416HH |
| 7.938 (0.313") -0.025/+0.000 (mm) | 11.113 +0.038/+0.063 | 12.700 +/-0.127 | 14.29 | 1.59 | BF0079-0111-0127-BS1416UH |
| 7.938 (0.313") +0.013/+0.038 (mm) | 11.113 +0.013/+0.038 | 12.700 +/-0.127 | 15.88 | 2.38 | BF0079-0111-0127-BS1624LL |
| 7.938 (0.313") +0.038/+0.064 (mm) | 11.113 +0.038/+0.064 | 15.875 +/-0.127 | 14.29 | 1.59 | BF0079-0111-0159-BS1416HH |
| 7.938 (0.313") +0.013/+0.038 (mm) | 11.113 +0.013/+0.038 | 15.875 +/-0.127 | 15.88 | 2.38 | BF0079-0111-0159-BS1624LL |
| 7.938 (0.313") +0.025/+0.051 (mm) | 11.113 +0.051/+0.076 | 19.050 +/-0.127 | 14.29 | 1.59 | BF0079-0111-0191-BS1416TH |



Stocked or Short Delivery



Usually Available Short Delivery



Long delivery or not in current production

* Large Minimum Quantities

** Available only while stock lasts

Bushes - Flanged

| Nominal ID (d) mm (inches) | Nominal OD (D) mm | Length (S) mm | Flange OD (D1) mm | Flange Thickness (S1) mm | Part Number |
|--------------------------------------|-------------------------|--------------------|----------------------|-----------------------------|----------------------------------|
| 7.938 (0.313") +0.038/+0.064 (mm) | 11.113 +0.038/+0.064 | 19.050 +/-0.127 | 14.29 | 1.59 | BF0079-0111-0191-BS1416HH |
| 7.938 (0.313") +0.012/+0.038 (mm) | 11.113 +0.012/+0.038 | 19.050 +/-0.191 | 15.88 | 2.38 | BF0079-0111-0191-BS1624LL |
| 7.938 (0.313") +0.038/+0.064 (mm) | 11.113 +0.038/+0.064 | 22.225 +/-0.127 | 14.29 | 1.59 | BF0079-0111-0222-BS1416HH |
| 7.938 (0.313") -0.025/+0.000 (mm) | 11.113 +0.038/+0.063 | 22.225 +/-0.127 | 14.29 | 1.59 | BF0079-0111-0222-BS1416UH |
| 7.938 (0.313") +0.013/+0.038 (mm) | 11.113 +0.013/+0.038 | 22.225 +/-0.127 | 15.88 | 2.38 | BF0079-0111-0222-BS1624LL |
| 7.938 (0.313") +0.038/+0.064 (mm) | 11.113 +0.038/+0.064 | 25.400 +/-0.127 | 14.29 | 1.59 | BF0079-0111-0254-BS1416HH |
| 7.938 (0.313") +0.013/+0.038 (mm) | 11.113 +0.013/+0.038 | 25.400 +/-0.127 | 15.88 | 2.38 | BF0079-0111-0254-BS1624LL |
| 7.938 (0.313") +0.025/+0.051 (mm) | 12.700 +0.028/+0.046 | 6.350 +/-0.127 | 15.88 | 1.58 | BF0079-0127-0064-BS1616TT |
| 7.938 (0.313") +0.000/+0.025 (mm) | 12.700 +0.025/+0.051 | 9.525 +/-0.127 | 14.29 | 1.59 | BF0079-0127-0095-BS1416LT |
| 7.938 (0.313") +0.025/+0.051 (mm) | 12.700 +0.028/+0.046 | 9.525 +/-0.127 | 15.88 | 1.58 | BF0079-0127-0095-BS1616TT |
| 7.938 (0.313") +0.012/+0.038 (mm) | 12.700 +0.025/+0.051 | 9.525 +/-0.191 | 17.46 | 2.38 | BF0079-0127-0095-BS1724LT |
| 7.938 (0.313") +0.025/+0.051 (mm) | 12.700 +0.051/+0.076 | 9.525 +/-0.127 | 17.46 | 2.38 | BF0079-0127-0095-BS1724TH |
| 7.938 (0.313") +0.000/+0.025 (mm) | 12.700 +0.076/+0.102 | 12.314 +/-0.127 | 14.27 | 1.65 | BF0079-0127-0123-BS1417LH |
| 7.938 (0.313") +0.025/+0.051 (mm) | 12.700 +0.028/+0.046 | 12.700 +/-0.127 | 15.88 | 1.58 | BF0079-0127-0127-BS1616TT |
| 7.938 (0.313") +0.012/+0.038 (mm) | 12.700 +0.025/+0.051 | 12.700 +/-0.191 | 17.46 | 2.38 | BF0079-0127-0127-BS1724LT |
| 7.938 (0.313") +0.012/+0.038 (mm) | 12.700 +0.025/+0.051 | 15.875 +/-0.191 | 17.46 | 2.38 | BF0079-0127-0159-BS1724LT |
| 7.938 (0.313") +0.025/+0.051 (mm) | 12.700 +0.028/+0.046 | 19.050 +/-0.127 | 15.88 | 1.58 | BF0079-0127-0191-BS1616TT |
| 7.938 (0.313") +0.000/+0.010 (mm) | 17.463 -0.010/+0.003 | 6.350 +0/-0.127 | 19.05 | 1.07 | BF0079-0175-0064-BS1911LU |
| 8.000 (0.315") +0.005/+0.030 (mm) | 11.000 +0.028/+0.050 | 6.000 +/-0.120 | 12.00 | 1.50 | BF0080-0110-0060-BS1215LT |
| 8.000 (0.315") +0.005/+0.030 (mm) | 11.000 +0.028/+0.050 | 10.000 +/-0.120 | 12.00 | 1.50 | BF0080-0110-0100-BS1215LT |
| 8.000 (0.315") +0.005/+0.030 (mm) | 11.000 +0.028/+0.050 | 12.000 +/-0.120 | 14.00 | 1.50 | BF0080-0110-0120-BS1415LT |
| 8.000 (0.315") +0.005/+0.030 (mm) | 12.000 +0.028/+0.050 | 6.000 +/-0.127 | 16.00 | 2.00 | BF0080-0120-0060-BS1620LT |
| 8.000 (0.315") +0.005/+0.030 (mm) | 12.000 +0.028/+0.050 | 8.000 +/-0.127 | 16.00 | 2.00 | BF0080-0120-0080-BS1620LT |
| 8.000 (0.315") +0.025/+0.051 (mm) | 12.000 +0.023/+0.041 | 8.000 +/-0.127 | 16.00 | 3.00 | BF0080-0120-0080-BS1630TT |
| 8.000 (0.315") +0.005/+0.030 (mm) | 12.000 +0.028/+0.050 | 12.000 +/-0.127 | 16.00 | 2.00 | BF0080-0120-0120-BS1620LT |
| 8.000 (0.315") +0.005/+0.030 (mm) | 12.000 +0.028/+0.050 | 14.000 +/-0.120 | 16.00 | 2.00 | BF0080-0120-0140-BS1620LT |
| 8.000 (0.315") +0.005/+0.030 (mm) | 12.000 +0.028/+0.050 | 16.000 +/-0.127 | 16.00 | 2.00 | BF0080-0120-0160-BS1620LT |
| 8.000 (0.315") +0.000/+0.015 (mm) | 16.000 -0.011/+0.000 | 6.000 +0/-0.170 | 18.00 | 1.00 | BF0080-0160-0060-BS1810LU |
| 9.000 (0.354") +0.005/+0.030 (mm) | 14.000 +0.028/+0.050 | 6.000 +/-0.120 | 19.00 | 2.50 | BF0090-0140-0060-BS1925LT |
| 9.000 (0.354") +0.005/+0.030 (mm) | 14.000 +0.028/+0.050 | 10.000 +/-0.120 | 19.00 | 2.50 | BF0090-0140-0100-BS1925LT |
| 9.000 (0.354") +0.005/+0.030 (mm) | 14.000 +0.028/+0.050 | 14.000 +/-0.120 | 19.00 | 2.50 | BF0090-0140-0140-BS1925LT |
| 9.525 (0.375") +0.012/+0.038 (mm) | 12.700 +0.025/+0.051 | 6.350 +/-0.127 | 15.88 | 1.59 | BF0095-0127-0064-BS1616LT |
| 9.525 (0.375") +0.025/+0.051 (mm) | 12.700 +0.025/+0.051 | 6.350 +/-0.127 | 15.88 | 1.59 | BF0095-0127-0064-BS1616TT |
| 9.525 (0.375") +0.025/+0.051 (mm) | 12.700 +0.051/+0.076 | 6.350 +/-0.127 | 17.45 | 2.38 | BF0095-0127-0064-BS1724TH |

Stocked or Short Delivery
 Usually Available Short Delivery
 Long delivery or not in current production

* Large Minimum Quantities

** Available only while stock lasts

Bushes - Flanged

| Nominal ID (d) mm (inches) | Nominal OD (D) mm | Length (S) mm | Flange OD (D1) mm | Flange Thickness (S1) mm | Part Number |
|--------------------------------------|-------------------------|---------------------|----------------------|-----------------------------|----------------------------------|
| 9.525 (0.375") +0.012/+0.038 (mm) | 12.700 +0.025/+0.051 | 7.938 +/-0.127 | 15.88 | 1.59 | BF0095-0127-0079-BS1616LT |
| 9.525 (0.375") +0.025/+0.051 (mm) | 12.700 +0.025/+0.051 | 7.938 +/-0.127 | 15.88 | 1.59 | BF0095-0127-0079-BS1616TT |
| 9.525 (0.375") +0.012/+0.038 (mm) | 12.700 +0.025/+0.051 | 9.525 +/-0.127 | 15.88 | 1.59 | BF0095-0127-0095-BS1616LT |
| 9.525 (0.375") +0.025/+0.051 (mm) | 12.700 +0.025/+0.051 | 9.525 | 15.880 | 1.59 | BF0095-0127-0095-BS1616TT |
| 9.525 (0.375") +0.025/+0.051 (mm) | 12.700 +0.051/+0.076 | 9.525 +/-0.127 | 17.45 | 2.38 | BF0095-0127-0095-BS1724TH |
| 9.525 (0.375") +0.025/+0.051 (mm) | 12.700 +0.025/+0.051 | 9.525 +/-0.191 | 17.46 | 2.38 | BF0095-0127-0095-BS1724TT |
| 9.525 (0.375") +0.000/+0.025 (mm) | 12.700 +0.076/+0.102 | 10.262 +/-0.127 | 14.27 | 1.65 | BF0095-0127-0102-BS1417LH |
| 9.525 (0.375") +0.025/+0.051 (mm) | 12.700 +0.025/+0.051 | 10.319 +/-0.191 | 17.46 | 2.38 | BF0095-0127-0103-BS1724TT |
| 9.525 (0.375") +0.012/+0.038 (mm) | 12.700 +0.025/+0.051 | 12.700 +/-0.127 | 15.88 | 1.59 | BF0095-0127-0127-BS1616LT |
| 9.525 (0.375") +0.025/+0.051 (mm) | 12.700 +0.025/+0.051 | 12.700 +/-0.127 | 15.88 | 1.59 | BF0095-0127-0127-BS1616TT |
| 9.525 (0.375") +0.012/+0.038 (mm) | 12.700 +0.051/+0.076 | 12.700 +/-0.127 | 15.88 | 2.38 | BF0095-0127-0127-BS1624LH |
| 9.525 (0.375") +0.025/+0.051 (mm) | 12.700 +0.028/+0.046 | 12.700 +/-0.127 | 15.88 | 3.56 | BF0095-0127-0127-BS1636TT |
| 9.525 (0.375") +0.025/+0.051 (mm) | 12.700 +0.025/+0.051 | 12.700 +/-0.127 | 17.45 | 2.38 | BF0095-0127-0127-BS1724TT |
| 9.525 (0.375") +0.025/+0.051 (mm) | 12.700 +0.051/+0.076 | 12.700 +/-0.127 | 17.45 | 2.38 | BF0095-0127-0127-BS1724TH |
| 9.525 (0.375") +0.051/+0.076 (mm) | 12.700 +0.051/+0.076 | 12.700 +/-0.127 | 19.05 | 2.38 | BF0095-0127-0127-BS1924HH |
| 9.525 (0.375") +0.025/+0.051 (mm) | 12.700 +0.025/+0.051 | 15.875 +/-0.127 | 15.88 | 1.59 | BF0095-0127-0159-BS1616TT |
| 9.525 (0.375") +0.012/+0.038 (mm) | 12.700 +0.051/+0.076 | 15.875 +/-0.127 | 15.88 | 2.38 | BF0095-0127-0159-BS1624LH |
| 9.525 (0.375") +0.025/+0.051 (mm) | 12.700 +0.025/+0.051 | 15.875 +/-0.191 | 17.46 | 2.38 | BF0095-0127-0159-BS1724TT |
| 9.525 (0.375") +0.025/+0.051 (mm) | 12.700 +0.076/+0.102 | 17.678 +0/-0.152 | 14.27 | 1.65 | BF0095-0127-0177-BS1417TH |
| 9.525 (0.375") +0.025/+0.051 (mm) | 12.700 +0.025/+0.051 | 19.050 +/-0.127 | 15.88 | 1.59 | BF0095-0127-0191-BS1616TT |
| 9.525 (0.375") +0.025/+0.051 (mm) | 12.700 +0.051/+0.076 | 19.050 +/-0.127 | 17.45 | 2.38 | BF0095-0127-0191-BS1724TH |
| 9.525 (0.375") +0.025/+0.051 (mm) | 12.700 +0.025/+0.051 | 19.050 +/-0.191 | 17.46 | 2.38 | BF0095-0127-0191-BS1724TT |
| 9.525 (0.375") +0.025/+0.051 (mm) | 12.700 +0.028/+0.046 | 22.225 +/-0.127 | 15.88 | 3.56 | BF0095-0127-0222-BS1636TT |
| 9.525 (0.375") +0.025/+0.051 (mm) | 12.700 +0.025/+0.051 | 22.225 +/-0.127 | 17.46 | 2.38 | BF0095-0127-0222-BS1724TT |
| 9.525 (0.375") +0.025/+0.051 (mm) | 12.700 +0.025/+0.051 | 25.400 +/-0.127 | 15.88 | 1.59 | BF0095-0127-0254-BS1616TT |
| 9.525 (0.375") +0.025/+0.051 (mm) | 12.700 +0.051/+0.076 | 25.400 +/-0.127 | 17.45 | 2.38 | BF0095-0127-0254-BS1724TH |
| 9.525 (0.375") +0.025/+0.051 (mm) | 12.700 +0.025/+0.051 | 25.400 +/-0.191 | 17.46 | 2.38 | BF0095-0127-0254-BS1724TT |
| 9.525 (0.375") +0.025/+0.051 (mm) | 12.700 +0.025/+0.051 | 31.750 +/-0.127 | 17.46 | 2.38 | * BF0095-0127-0318-BS1724TT |
| 9.525 (0.375") +0.025/+0.051 (mm) | 14.288 +0.051/+0.076 | 12.700 +/-0.127 | 17.46 | 1.59 | BF0095-0143-0127-BS1716TH |
| 9.525 (0.375") +0.000/+0.025 (mm) | 14.288 +0.012/+0.038 | 12.700 +/-0.127 | 18.80 | 1.59 | BF0095-0143-0127-BS1916LL |
| 9.525 (0.375") +0.025/+0.051 (mm) | 14.288 +0.025/+0.051 | 12.700 +/-0.127 | 18.80 | 3.18 | BF0095-0143-0127-BS1932TT |
| 9.525 (0.375") +0.025/+0.051 (mm) | 14.288 +0.051/+0.076 | 12.700 +/-0.127 | 19.05 | 1.59 | BF0095-0143-0127-BS1916TH |
| 9.525 (0.375") +0.025/+0.051 (mm) | 14.288 +0.063/+0.089 | 16.764 +/-0.127 | 19.05 | 2.36 | BF0095-0143-0168-BS1924TH |
| 9.525 (0.375") +0.000/+0.025 (mm) | 14.288 +0.012/+0.038 | 17.463 +/-0.127 | 18.80 | 1.59 | BF0095-0143-0175-BS1916LL |

Stocked or Short Delivery
 Usually Available Short Delivery
 Long delivery or not in current production

* Large Minimum Quantities

** Available only while stock lasts

Bushes - Flanged

| Nominal ID (d) mm (inches) | Nominal OD (D) mm | Length (S) mm | Flange OD (D1) mm | Flange Thickness (S1) mm | Part Number |
|---------------------------------------|-------------------------|--------------------|----------------------|-----------------------------|---------------------------|
| 9.525 (0.375") +0.025/+0.051 (mm) | 14.288 +0.025/+0.051 | 19.050 +/-0.191 | 19.05 | 3.18 | BF0095-0143-0191-BS1932TT |
| 9.525 (0.375") +0.000/+0.025 (mm) | 14.288 +0.012/+0.038 | 20.638 +/-0.127 | 18.80 | 1.59 | BF0095-0143-0206-BS1916LL |
| 9.525 (0.375") +0.025/+0.051 (mm) | 14.288 +0.025/+0.051 | 31.750 +/-0.127 | 19.05 | 3.18 | BF0095-0143-0318-BS1932TT |
| 9.525 (0.375") +0.025/+0.051 (mm) | 15.875 +0.028/+0.046 | 9.525 +/-0.127 | 19.05 | 3.18 | BF0095-0159-0095-BS1932TT |
| 9.525 (0.375") +0.025/+0.051 (mm) | 15.875 +0.025/+0.051 | 9.525 +/-0.127 | 22.23 | 3.18 | BF0095-0159-0095-BS2232TT |
| 9.525 (0.375") +0.025/+0.051 (mm) | 15.875 +0.028/+0.046 | 12.700 +/-0.127 | 19.05 | 3.18 | BF0095-0159-0127-BS1932TT |
| 9.525 (0.375") +0.000/+0.025 (mm) | 15.875 +0.025/+0.051 | 12.700 +/-0.127 | 22.23 | 1.59 | BF0095-0159-0127-BS2216LT |
| 9.525 (0.375") +0.025/+0.051 (mm) | 15.875 +0.025/+0.051 | 12.700 +/-0.127 | 22.23 | 1.59 | BF0095-0159-0127-BS2216TT |
| 9.525 (0.375") +0.025/+0.051 (mm) | 15.875 +0.051/+0.076 | 12.700 +/-0.127 | 22.23 | 1.59 | BF0095-0159-0127-BS2216TH |
| 9.525 (0.375") +0.025/+0.051 (mm) | 15.875 +0.025/+0.051 | 12.700 | 22.230 | 3.18 | BF0095-0159-0127-BS2232TT |
| 9.525 (0.375") +0.051/+0.076 (mm) | 15.875 +0.076/+0.102 | 15.494 +/-0.127 | 22.23 | 1.60 | BF0095-0159-0159-BS2216HH |
| 9.525 (0.375") +0.025/+0.051 (mm) | 15.875 +0.028/+0.046 | 15.875 +/-0.127 | 19.05 | 3.18 | BF0095-0159-0159-BS1932TT |
| 9.525 (0.375") +0.025/+0.051 (mm) | 15.875 +0.025/+0.051 | 15.875 +/-0.127 | 22.23 | 3.18 | BF0095-0159-0159-BS2232TT |
| 9.525 (0.375") +0.025/+0.051 (mm) | 15.875 +0.028/+0.046 | 19.050 +/-0.127 | 19.05 | 3.18 | BF0095-0159-0191-BS1932TT |
| 9.525 (0.375") +0.000/+0.025 (mm) | 15.875 +0.025/+0.051 | 19.050 +/-0.127 | 22.23 | 1.59 | BF0095-0159-0191-BS2216LT |
| 9.525 (0.375") +0.025/+0.051 (mm) | 15.875 +0.025/+0.051 | 19.050 +/-0.127 | 22.23 | 1.59 | BF0095-0159-0191-BS2216TT |
| 9.525 (0.375") +0.025/+0.051 (mm) | 15.875 +0.051/+0.076 | 19.050 +/-0.127 | 22.23 | 1.59 | BF0095-0159-0191-BS2216TH |
| 9.525 (0.375") +0.025/+0.051 (mm) | 15.875 +0.025/+0.051 | 19.050 +/-0.191 | 22.23 | 3.18 | BF0095-0159-0191-BS2232TT |
| 9.525 (0.375") +0.025/+0.051 (mm) | 15.875 +0.025/+0.051 | 25.400 +/-0.127 | 22.23 | 1.59 | BF0095-0159-0254-BS2216TT |
| 9.525 (0.375") +0.025/+0.051 (mm) | 15.875 +0.051/+0.076 | 25.400 +/-0.127 | 22.23 | 1.59 | BF0095-0159-0254-BS2216TH |
| 9.525 (0.375") +0.025/+0.051 (mm) | 15.875 +0.025/+0.051 | 25.400 +/-0.191 | 22.23 | 3.18 | BF0095-0159-0254-BS2232TT |
| 9.525 (0.375") +0.000/+0.025 (mm) | 15.875 +0.025/+0.051 | 31.750 +/-0.127 | 22.23 | 1.59 | BF0095-0159-0318-BS2216LT |
| 9.525 (0.375") +0.025/+0.051 (mm) | 15.875 +0.025/+0.051 | 31.750 +/-0.127 | 22.23 | 1.59 | BF0095-0159-0318-BS2216TT |
| 9.525 (0.375") +0.025/+0.051 (mm) | 15.875 +0.051/+0.076 | 31.750 +/-0.127 | 22.23 | 1.59 | BF0095-0159-0318-BS2216TH |
| 9.525 (0.375") +0.025/+0.051 (mm) | 15.875 +0.025/+0.051 | 31.750 +/-0.127 | 22.23 | 3.18 | BF0095-0159-0318-BS2232TT |
| 9.525 (0.375") +0.025/+0.051 (mm) | 19.050 +0.051/+0.076 | 12.700 +/-0.191 | 25.40 | 3.18 | BF0095-0191-0127-BS2532TH |
| 10.000 (0.394") +0.005/+0.030 (mm) | 13.000 +0.028/+0.050 | 6.000 +/-0.120 | 16.00 | 1.50 | BF0100-0130-0060-BS1615LT |
| 10.000 (0.394") +0.005/+0.030 (mm) | 13.000 +0.028/+0.050 | 8.000 +/-0.120 | 16.00 | 1.50 | BF0100-0130-0080-BS1615LT |
| 10.000 (0.394") +0.005/+0.030 (mm) | 13.000 +0.028/+0.050 | 10.000 +/-0.120 | 16.00 | 1.50 | BF0100-0130-0100-BS1615LT |
| 10.000 (0.394") +0.005/+0.030 (mm) | 13.000 +0.028/+0.050 | 12.000 +/-0.120 | 16.00 | 1.50 | BF0100-0130-0120-BS1615LT |
| 10.000 (0.394") +0.005/+0.030 (mm) | 13.000 +0.028/+0.050 | 16.000 +/-0.120 | 16.00 | 1.50 | BF0100-0130-0160-BS1615LT |
| 10.000 (0.394") +0.005/+0.030 (mm) | 13.000 +0.028/+0.050 | 20.000 +/-0.120 | 16.00 | 1.50 | BF0100-0130-0200-BS1615LT |
| 10.000 (0.394") +0.005/+0.030 (mm) | 15.000 +0.028/+0.050 | 10.000 +/-0.127 | 20.00 | 2.50 | BF0100-0150-0100-BS2025LT |
| 10.000 (0.394") +0.005/+0.030 (mm) | 15.000 +0.028/+0.050 | 10.000 +/-0.127 | 20.00 | 3.00 | BF0100-0150-0100-BS2030LT |



Stocked or Short Delivery



Usually Available Short Delivery



Long delivery or not in current production

* Large Minimum Quantities

** Available only while stock lasts

Bushes - Flanged

| Nominal ID (d) mm (inches) | Nominal OD (D) mm | Length (S) mm | Flange OD (D1) mm | Flange Thickness (S1) mm | Part Number |
|---------------------------------------|-------------------------|---------------------|----------------------|-----------------------------|---------------------------|
| 10.000 (0.394") +0.005/+0.030 (mm) | 15.000 +0.028/+0.050 | 10.000 +/-0.127 | 21.00 | 3.00 | BF0100-0150-0100-BS2130LT |
| 10.000 (0.394") +0.005/+0.030 (mm) | 15.000 +0.028/+0.050 | 16.000 +/-0.127 | 20.00 | 2.50 | BF0100-0150-0160-BS2025LT |
| 10.000 (0.394") +0.005/+0.030 (mm) | 15.000 +0.028/+0.050 | 16.000 +/-0.127 | 20.00 | 3.00 | BF0100-0150-0160-BS2030LT |
| 10.000 (0.394") +0.005/+0.030 (mm) | 15.000 +0.028/+0.050 | 16.000 +/-0.127 | 21.00 | 3.00 | BF0100-0150-0160-BS2130LT |
| 10.000 (0.394") +0.005/+0.030 (mm) | 15.000 +0.028/+0.050 | 20.000 +/-0.127 | 21.00 | 3.00 | BF0100-0150-0200-BS2130LT |
| 10.000 (0.394") +0.025/+0.040 (mm) | 16.000 +0.023/+0.050 | 8.000 +0/-0.200 | 20.00 | 3.00 | BF0100-0160-0080-BS2030LT |
| 10.000 (0.394") +0.005/+0.030 (mm) | 16.000 +0.028/+0.050 | 8.000 +/-0.127 | 22.00 | 3.00 | BF0100-0160-0080-BS2230LT |
| 10.000 (0.394") +0.025/+0.040 (mm) | 16.000 +0.023/+0.041 | 10.000 +0/-0.200 | 20.00 | 3.00 | BF0100-0160-0100-BS2030LT |
| 10.000 (0.394") +0.005/+0.030 (mm) | 16.000 +0.028/+0.050 | 10.000 +/-0.127 | 22.00 | 3.00 | BF0100-0160-0100-BS2230LT |
| 10.000 (0.394") +0.025/+0.051 (mm) | 16.000 +0.028/+0.046 | 16.000 +/-0.127 | 20.00 | 3.00 | BF0100-0160-0160-BS2030TT |
| 10.000 (0.394") +0.005/+0.030 (mm) | 16.000 +0.028/+0.050 | 16.000 +/-0.127 | 22.00 | 3.00 | BF0100-0160-0160-BS2230LT |
| 10.000 (0.394") +0.000/+0.015 (mm) | 19.000 -0.013/+0.000 | 7.000 +0/-0.170 | 21.00 | 1.50 | BF0100-0190-0070-BS2115LU |
| 11.113 (0.438") +0.012/+0.038 (mm) | 12.700 +0.076/+0.102 | 3.912 +/-0.127 | 14.27 | 1.96 | BF0111-0127-0039-BS1420LH |
| 11.113 (0.438") +0.012/+0.038 (mm) | 14.288 +0.051/+0.076 | 7.137 +/-0.127 | 19.84 | 1.65 | BF0111-0143-0071-BS2017LH |
| 11.113 (0.438") +0.012/+0.038 (mm) | 14.288 +0.038/+0.063 | 12.700 +/-0.127 | 17.46 | 1.59 | BF0111-0143-0127-BS1716LH |
| 11.113 (0.438") +0.025/+0.051 (mm) | 14.288 +0.051/+0.076 | 12.700 +/-0.127 | 17.46 | 1.59 | BF0111-0143-0127-BS1716TH |
| 11.113 (0.438") +0.012/+0.038 (mm) | 14.288 +0.051/+0.076 | 13.868 +/-0.127 | 19.84 | 1.65 | BF0111-0143-0139-BS2017LH |
| 11.113 (0.438") +0.012/+0.038 (mm) | 14.288 +0.038/+0.063 | 15.875 +/-0.127 | 17.46 | 1.59 | BF0111-0143-0159-BS1716LH |
| 11.113 (0.438") +0.012/+0.038 (mm) | 14.288 +0.038/+0.063 | 19.050 +/-0.127 | 17.46 | 1.59 | BF0111-0143-0191-BS1716LH |
| 11.113 (0.438") +0.025/+0.051 (mm) | 14.288 +0.051/+0.076 | 19.050 +/-0.127 | 17.46 | 1.59 | BF0111-0143-0191-BS1716TH |
| 11.113 (0.438") +0.012/+0.038 (mm) | 15.875 +0.025/+0.051 | 15.875 +/-0.191 | 22.23 | 3.18 | BF0111-0159-0159-BS2232LT |
| 11.113 (0.438") +0.013/+0.038 (mm) | 15.875 +0.051/+0.076 | 15.875 | 22.230 | 3.18 | BF0111-0159-0159-BS2232LH |
| 11.113 (0.438") +0.000/+0.025 (mm) | 15.875 +0.025/+0.051 | 19.050 +/-0.127 | 22.23 | 3.18 | BF0111-0159-0191-BS2232LT |
| 11.113 (0.438") +0.013/+0.038 (mm) | 15.875 +0.051/+0.076 | 19.050 +/-0.127 | 22.23 | 3.18 | BF0111-0159-0191-BS2232LH |
| 11.113 (0.438") +0.025/+0.051 (mm) | 15.875 +0.051/+0.076 | 19.050 +/-0.127 | 22.23 | 3.18 | BF0111-0159-0191-BS2232TH |
| 11.113 (0.438") +0.013/+0.038 (mm) | 15.875 +0.051/+0.076 | 25.400 +/-0.127 | 22.23 | 3.18 | BF0111-0159-0254-BS2232LH |
| 11.113 (0.438") +0.000/+0.025 (mm) | 15.875 +0.025/+0.051 | 31.750 +/-0.127 | 22.22 | 3.18 | BF0111-0159-0318-BS2232LT |
| 11.113 (0.438") +0.025/+0.051 (mm) | 15.875 +0.051/+0.076 | 31.750 +/-0.127 | 22.23 | 3.18 | BF0111-0159-0318-BS2232TH |
| 11.113 (0.438") +0.013/+0.038 (mm) | 15.875 +0.051/+0.076 | 31.750 | 22.230 | 3.18 | BF0111-0159-0318-BS2232LH |
| 12.000 (0.472") +0.005/+0.030 (mm) | 15.000 +0.028/+0.050 | 7.000 +/-0.127 | 18.00 | 1.50 | BF0120-0150-0070-BS1815LT |
| 12.000 (0.472") +0.005/+0.030 (mm) | 15.000 +0.028/+0.050 | 12.000 +/-0.127 | 18.00 | 1.50 | BF0120-0150-0120-BS1815LT |
| 12.000 (0.472") +0.005/+0.030 (mm) | 15.000 +0.028/+0.050 | 16.000 +/-0.127 | 18.00 | 1.50 | BF0120-0150-0160-BS1815LT |
| 12.000 (0.472") +0.005/+0.030 (mm) | 15.000 +0.028/+0.050 | 20.000 +/-0.127 | 18.00 | 1.50 | BF0120-0150-0200-BS1815LT |
| 12.000 (0.472") +0.025/+0.051 (mm) | 15.000 +0.028/+0.046 | 20.000 +/-0.127 | 21.00 | 3.00 | BF0120-0150-0200-BS2130TT |



Stocked or Short Delivery



Usually Available Short Delivery



Long delivery or not in current production

* Large Minimum Quantities

** Available only while stock lasts

Bushes - Flanged

| Nominal ID (d) mm (inches) | Nominal OD (D) mm | Length (S) mm | Flange OD (D1) mm | Flange Thickness (S1) mm | Part Number |
|---------------------------------------|-------------------------|---------------------|----------------------|-----------------------------|----------------------------------|
| 12.000 (0.472") +0.005/+0.030 (mm) | 16.000 +0.028/+0.050 | 12.000 +/-0.127 | 20.00 | 2.00 | BF0120-0160-0120-BS2020LT |
| 12.000 (0.472") +0.005/+0.030 (mm) | 17.000 +0.028/+0.050 | 12.000 +/-0.127 | 22.00 | 2.50 | BF0120-0170-0120-BS2225LT |
| 12.000 (0.472") +0.005/+0.030 (mm) | 16.000 +0.028/+0.050 | 16.000 +/-0.127 | 20.00 | 2.00 | BF0120-0160-0160-BS2020LT |
| 12.000 (0.472") +0.005/+0.030 (mm) | 17.000 +0.028/+0.050 | 16.000 +/-0.127 | 22.00 | 2.50 | BF0120-0170-0160-BS2225LT |
| 12.000 (0.472") +0.005/+0.030 (mm) | 17.000 +0.028/+0.050 | 20.000 +/-0.127 | 22.00 | 2.50 | BF0120-0170-0200-BS2225LT |
| 12.000 (0.472") +0.005/+0.030 (mm) | 16.000 +0.028/+0.050 | 25.000 +/-0.127 | 20.00 | 2.00 | BF0120-0160-0250-BS2020LT |
| 12.000 (0.472") +0.005/+0.030 (mm) | 17.000 +0.028/+0.050 | 25.000 +/-0.127 | 22.00 | 2.50 | BF0120-0170-0250-BS2225LT |
| 12.000 (0.472") +0.005/+0.030 (mm) | 18.000 +0.028/+0.050 | 8.000 +/-0.127 | 24.00 | 3.00 | BF0120-0180-0080-BS2430LT |
| 12.000 (0.472") +0.005/+0.030 (mm) | 18.000 +0.028/+0.050 | 10.000 +0/-0.200 | 22.00 | 3.00 | BF0120-0180-0100-BS2230TL |
| 12.000 (0.472") +0.005/+0.030 (mm) | 18.000 +0.028/+0.050 | 10.000 +/-0.127 | 24.00 | 3.00 | BF0120-0180-0100-BS2430LT |
| 12.000 (0.472") +0.032/+0.050 (mm) | 18.000 +0.023/+0.041 | 12.000 +0/-0.200 | 22.00 | 3.00 | BF0120-0180-0120-BS2230TT |
| 12.000 (0.472") +0.005/+0.030 (mm) | 18.000 +0.028/+0.050 | 12.000 +/-0.127 | 24.00 | 3.00 | BF0120-0180-0120-BS2430LT |
| 12.000 (0.472") +0.005/+0.030 (mm) | 18.000 +0.028/+0.050 | 16.000 +/-0.127 | 24.00 | 3.00 | BF0120-0180-0160-BS2430LT |
| 12.000 (0.472") +0.005/+0.030 (mm) | 18.000 +0.028/+0.050 | 20.000 +/-0.127 | 24.00 | 3.00 | BF0120-0180-0200-BS2430LT |
| 12.000 (0.472") +0.000/+0.018 (mm) | 20.000 -0.013/+0.000 | 8.000 +0/-0.170 | 22.00 | 1.50 | BF0120-0200-0080-BS2215LU |
| 12.700 (0.500") +0.025/+0.051 (mm) | 15.875 +0.076/+0.102 | 3.531 -0.178/+0 | 22.23 | 1.27 | BF0127-0159-0035-BS2213TH |
| 12.700 (0.500") +0.025/+0.051 (mm) | 15.875 +0.025/+0.051 | 4.763 +/-0.127 | 22.23 | 1.59 | BF0127-0159-0048-BS2216TT |
| 12.700 (0.500") +0.000/+0.025 (mm) | 15.875 +0.051/+0.076 | 5.029 +0/-0.152 | 22.10 | 1.07 | BF0127-0159-0050-BS2211LH |
| 12.700 (0.500") +0.025/+0.051 (mm) | 15.875 +0.076/+0.102 | 6.350 +/-0.127 | 20.62 | 2.41 | BF0127-0159-0064-BS2124TH |
| 12.700 (0.500") +0.025/+0.051 (mm) | 15.875 +0.025/+0.051 | 6.350 +/-0.127 | 22.23 | 1.59 | BF0127-0159-0064-BS2216TT |
| 12.700 (0.500") +0.025/+0.051 (mm) | 15.875 +0.076/+0.102 | 7.798 +/-0.127 | 22.23 | 1.65 | BF0127-0159-0078-BS2217TH |
| 12.700 (0.500") +0.025/+0.051 (mm) | 15.875 +0.025/+0.051 | 7.938 +/-0.127 | 19.05 | 2.38 | BF0127-0159-0079-BS1924TT |
| 12.700 (0.500") +0.025/+0.051 (mm) | 15.875 +0.051/+0.076 | 7.938 +/-0.127 | 22.23 | 3.18 | BF0127-0159-0079-BS2232TH |
| 12.700 (0.500") +0.025/+0.051 (mm) | 15.875 +0.025/+0.051 | 9.525 +/-0.127 | 19.05 | 2.38 | BF0127-0159-0095-BS1924TT |
| 12.700 (0.500") +0.025/+0.051 (mm) | 15.875 +0.051/+0.076 | 9.525 +/-0.127 | 22.230 | 3.18 | BF0127-0159-0095-BS2232TH |
| 12.700 (0.500") +0.025/+0.051 (mm) | 15.875 +0.028/+0.046 | 12.700 +/-0.127 | 19.05 | 2.38 | BF0127-0159-0127-BS1924TT |
| 12.700 (0.500") +0.025/+0.051 (mm) | 15.875 +0.025/+0.051 | 12.700 +/-0.127 | 22.23 | 1.59 | BF0127-0159-0127-BS2216TT |
| 12.700 (0.500") +0.025/+0.051 (mm) | 15.875 +0.051/+0.076 | 12.700 | 22.230 | 3.18 | BF0127-0159-0127-BS2232TH |
| 12.700 (0.500") +0.025/+0.051 (mm) | 15.875 +0.025/+0.051 | 12.700 | 24.610 | 2.38 | BF0127-0159-0127-BS2524TT |
| 12.700 (0.500") +0.025/+0.051 (mm) | 15.875 +0.076/+0.102 | 14.275 +/-0.127 | 22.23 | 1.65 | BF0127-0159-0143-BS2217TH |
| 12.700 (0.500") +0.025/+0.051 (mm) | 15.875 +0.025/+0.051 | 14.275 | 22.230 | 1.59 | BF0127-0159-0143-BS2216TT |
| 12.700 (0.500") +0.025/+0.051 (mm) | 15.875 +0.025/+0.051 | 15.875 | 22.230 | 1.59 | BF0127-0159-0159-BS2216TT |
| 12.700 (0.500") +0.025/+0.051 (mm) | 15.875 +0.025/+0.051 | 15.875 | 22.230 | 3.18 | BF0127-0159-0159-BS2232TT |
| 12.700 (0.500") +0.025/+0.051 (mm) | 15.875 +0.051/+0.076 | 15.875 | 22.230 | 3.18 | BF0127-0159-0159-BS2232TH |

 Stocked or Short Delivery
 Usually Available Short Delivery
 Long delivery or not in current production

* Large Minimum Quantities

** Available only while stock lasts

Bushes - Flanged

| Nominal ID (d) mm (inches) | Nominal OD (D) mm | Length (S) mm | Flange OD (D1) mm | Flange Thickness (S1) mm | Part Number |
|---------------------------------------|-------------------------|--------------------|----------------------|-----------------------------|----------------------------------|
| 12.700 (0.500") +0.025/+0.051 (mm) | 15.875 +0.025/+0.051 | 17.463 +/-0.127 | 22.23 | 1.59 | BF0127-0159-0175-BS2216TT |
| 12.700 (0.500") +0.025/+0.051 (mm) | 15.875 +0.025/+0.051 | 19.050 | 22.230 | 1.59 | BF0127-0159-0191-BS2216TT |
| 12.700 (0.500") +0.025/+0.051 (mm) | 15.875 +0.051/+0.076 | 19.050 | 22.230 | 3.18 | BF0127-0159-0191-BS2232TH |
| 12.700 (0.500") +0.025/+0.051 (mm) | 15.875 +0.051/+0.076 | 22.225 +/-0.127 | 22.23 | 3.18 | BF0127-0159-0222-BS2232TH |
| 12.700 (0.500") +0.025/+0.051 (mm) | 15.875 +0.025/+0.051 | 23.813 +/-0.127 | 22.23 | 1.59 | BF0127-0159-0238-BS2216TT |
| 12.700 (0.500") +0.025/+0.051 (mm) | 15.875 +0.028/+0.046 | 25.400 +/-0.127 | 19.05 | 2.38 | BF0127-0159-0254-BS1924TT |
| 12.700 (0.500") +0.025/+0.051 (mm) | 15.875 +0.025/+0.051 | 25.400 +/-0.127 | 22.23 | 1.59 | BF0127-0159-0254-BS2216TT |
| 12.700 (0.500") +0.025/+0.051 (mm) | 15.875 +0.051/+0.076 | 25.400 +/-0.127 | 22.23 | 3.18 | BF0127-0159-0254-BS2232TH |
| 12.700 (0.500") +0.025/+0.051 (mm) | 15.875 +0.025/+0.051 | 25.400 +/-0.127 | 24.61 | 2.38 | BF0127-0159-0254-BS2524TT |
| 12.700 (0.500") +0.025/+0.051 (mm) | 15.875 +0.025/+0.051 | 28.575 +/-0.127 | 22.23 | 1.59 | BF0127-0159-0286-BS2216TT |
| 12.700 (0.500") +0.025/+0.051 (mm) | 15.875 +0.025/+0.051 | 31.750 +/-0.127 | 22.23 | 1.59 | BF0127-0159-0318-BS2216TT |
| 12.700 (0.500") +0.025/+0.051 (mm) | 15.875 +0.051/+0.076 | 31.750 | 22.230 | 3.18 | BF0127-0159-0318-BS2232TH |
| 12.700 (0.500") +0.025/+0.051 (mm) | 15.875 +0.025/+0.051 | 38.100 +/-0.127 | 22.23 | 1.59 | BF0127-0159-0381-BS2216TT |
| 12.700 (0.500") +0.025/+0.051 (mm) | 15.875 +0.051/+0.076 | 38.100 | 22.230 | 3.18 | BF0127-0159-0381-BS2232TH |
| 12.700 (0.500") +0.025/+0.051 (mm) | 15.875 +0.051/+0.076 | 44.450 | 22.230 | 3.18 | BF0127-0159-0445-BS2232TH |
| 12.700 (0.500") +0.025/+0.051 (mm) | 15.875 +0.025/+0.051 | 44.450 +/-0.190 | 24.61 | 2.38 | BF0127-0159-0445-BS2524TT |
| 12.700 (0.500") +0.025/+0.051 (mm) | 17.463 +0.063/+0.089 | 7.938 +/-0.127 | 20.64 | 1.59 | BF0127-0175-0079-BS2116TH |
| 12.700 (0.500") +0.025/+0.051 (mm) | 17.463 +0.051/+0.076 | 7.938 +/-0.127 | 22.23 | 3.18 | BF0127-0175-0079-BS2232TH |
| 12.700 (0.500") +0.025/+0.051 (mm) | 17.463 +0.063/+0.089 | 12.700 +/-0.127 | 20.64 | 1.59 | BF0127-0175-0127-BS2116TH |
| 12.700 (0.500") +0.025/+0.051 (mm) | 17.463 +0.051/+0.076 | 12.700 +/-0.127 | 22.23 | 3.18 | BF0127-0175-0127-BS2232TH |
| 12.700 (0.500") +0.025/+0.051 (mm) | 17.463 +0.038/+0.063 | 12.700 +/-0.191 | 23.84 | 3.18 | BF0127-0175-0127-BS2432TH |
| 12.700 (0.500") +0.025/+0.051 (mm) | 17.463 +0.063/+0.089 | 12.700 +/-0.127 | 24.61 | 2.38 | BF0127-0175-0127-BS2524TH |
| 12.700 (0.500") +0.025/+0.051 (mm) | 17.463 +0.038/+0.064 | 15.875 +/-0.127 | 23.84 | 3.18 | BF0127-0175-0159-BS2432TH |
| 12.700 (0.500") +0.025/+0.051 (mm) | 17.463 +0.063/+0.089 | 19.050 +/-0.127 | 20.64 | 1.59 | BF0127-0175-0191-BS2116TH |
| 12.700 (0.500") +0.025/+0.051 (mm) | 17.463 +0.051/+0.076 | 19.050 +/-0.127 | 22.23 | 3.18 | BF0127-0175-0191-BS2232TH |
| 12.700 (0.500") +0.025/+0.051 (mm) | 17.463 +0.038/+0.063 | 19.050 +/-0.191 | 23.84 | 3.18 | BF0127-0175-0191-BS2432TH |
| 12.700 (0.500") +0.025/+0.051 (mm) | 17.463 +0.063/+0.089 | 19.050 +/-0.127 | 24.61 | 2.38 | BF0127-0175-0191-BS2524TH |
| 12.700 (0.500") +0.025/+0.051 (mm) | 17.463 +0.063/+0.089 | 20.638 +/-0.127 | 20.64 | 1.59 | BF0127-0175-0206-BS2116TH |
| 12.700 (0.500") +0.025/+0.051 (mm) | 17.463 +0.063/+0.089 | 20.638 +/-0.127 | 24.61 | 2.38 | BF0127-0175-0206-BS2524TH |
| 12.700 (0.500") +0.025/+0.051 (mm) | 17.463 +0.051/+0.076 | 22.225 +/-0.127 | 22.23 | 3.18 | BF0127-0175-0222-BS2232TH |
| 12.700 (0.500") +0.025/+0.051 (mm) | 19.050 +0.051/+0.076 | 9.525 +/-0.127 | 23.81 | 3.18 | BF0127-0191-0095-BS2432TH |
| 12.700 (0.500") +0.102/+0.127 (mm) | 19.050 +0.051/+0.076 | 9.525 +/-0.127 | 25.40 | 3.18 | BF0127-0191-0095-BS2532HH |
| 12.700 (0.500") +0.025/+0.051 (mm) | 19.050 +0.051/+0.076 | 12.700 +/-0.127 | 23.81 | 3.18 | BF0127-0191-0127-BS2432TH |
| 12.700 (0.500") +0.025/+0.051 (mm) | 19.050 +0.051/+0.076 | 12.700 +/-0.127 | 25.40 | 3.18 | BF0127-0191-0127-BS2532TH |

Stocked or Short Delivery
 Usually Available Short Delivery
 Long delivery or not in current production

* Large Minimum Quantities

** Available only while stock lasts

Bushes - Flanged

| Nominal ID (d) mm (inches) | Nominal OD (D) mm | Length (S) mm | Flange OD (D1) mm | Flange Thickness (S1) mm | Part Number |
|---------------------------------------|-------------------------|--------------------|----------------------|-----------------------------|----------------------------------|
| 12.700 (0.500") +0.102/+0.127 (mm) | 19.050 +0.051/+0.076 | 12.700 +/-0.127 | 25.40 | 3.18 | BF0127-0191-0127-BS2532HH |
| 12.700 (0.500") +0.025/+0.051 (mm) | 19.050 +0.076/+0.102 | 13.081 +/-0.127 | 22.23 | 3.68 | BF0127-0191-0131-BS2237TH |
| 12.700 (0.500") +0.025/+0.051 (mm) | 19.050 +0.051/+0.076 | 14.684 +/-0.127 | 25.40 | 3.18 | BF0127-0191-0147-BS2532TH |
| 12.700 (0.500") +0.025/+0.051 (mm) | 19.050 +0.051/+0.076 | 15.875 +/-0.127 | 23.81 | 3.18 | BF0127-0191-0159-BS2432TH |
| 12.700 (0.500") +0.025/+0.051 (mm) | 19.050 +0.051/+0.076 | 15.875 +/-0.191 | 25.40 | 3.18 | BF0127-0191-0159-BS2532TH |
| 12.700 (0.500") +0.102/+0.127 (mm) | 19.050 +0.051/+0.076 | 15.875 +/-0.127 | 25.40 | 3.18 | BF0127-0191-0159-BS2532HH |
| 12.700 (0.500") +0.025/+0.051 (mm) | 19.050 +0.051/+0.076 | 19.050 +/-0.127 | 23.81 | 3.18 | BF0127-0191-0191-BS2432TH |
| 12.700 (0.500") +0.051/+0.076 (mm) | 19.050 +0.051/+0.076 | 19.050 +/-0.127 | 23.81 | 3.18 | BF0127-0191-0191-BS2432HH |
| 12.700 (0.500") +0.025/+0.051 (mm) | 19.050 +0.051/+0.076 | 19.050 +/-0.127 | 25.40 | 3.18 | BF0127-0191-0191-BS2532TH |
| 12.700 (0.500") +0.025/+0.051 (mm) | 19.050 +0.051/+0.076 | 22.225 +/-0.191 | 25.40 | 3.18 | BF0127-0191-0222-BS2532TH |
| 12.700 (0.500") +0.025/+0.051 (mm) | 19.050 +0.076/+0.102 | 24.613 +/-0.127 | 22.23 | 1.52 | BF0127-0191-0246-BS2215TH |
| 12.700 (0.500") +0.025/+0.051 (mm) | 19.050 +0.051/+0.076 | 25.400 +/-0.127 | 23.81 | 3.18 | BF0127-0191-0254-BS2430TH |
| 12.700 (0.500") +0.025/+0.051 (mm) | 19.050 +0.051/+0.076 | 25.400 +/-0.191 | 25.40 | 3.18 | BF0127-0191-0254-BS2532TH |
| 12.700 (0.500") +0.025/+0.051 (mm) | 19.050 +0.051/+0.076 | 31.750 +/-0.127 | 23.81 | 3.18 | BF0127-0191-0318-BS2432TH |
| 12.700 (0.500") +0.025/+0.051 (mm) | 19.050 +0.051/+0.076 | 31.750 +/-0.127 | 25.40 | 3.18 | BF0127-0191-0318-BS2532TH |
| 12.700 (0.500") +0.025/+0.051 (mm) | 19.050 +0.051/+0.076 | 38.100 +/-0.127 | 23.81 | 3.18 | BF0127-0191-0381-BS2432TH |
| 12.700 (0.500") +0.025/+0.051 (mm) | 19.050 +0.051/+0.076 | 38.100 +/-0.127 | 25.40 | 3.18 | BF0127-0191-0381-BS2532TH |
| 12.700 (0.500") +0.000/+0.010 (mm) | 28.575 -0.010/+0.003 | 7.938 +0/-0.127 | 31.75 | 1.57 | BF0127-0286-0079-BS3216LU |
| 14.000 (0.551") +0.025/+0.051 (mm) | 18.000 +0.035/+0.056 | 12.000 +/-0.127 | 22.00 | 2.00 | BF0140-0180-0120-BS2220LT |
| 14.000 (0.551") +0.025/+0.051 (mm) | 18.000 +0.035/+0.056 | 14.000 +/-0.127 | 22.00 | 2.00 | BF0140-0180-0140-BS2220LT |
| 14.000 (0.551") +0.025/+0.051 (mm) | 18.000 +0.035/+0.056 | 18.000 +/-0.127 | 22.00 | 2.00 | BF0140-0180-0180-BS2220LT |
| 14.000 (0.551") +0.025/+0.051 (mm) | 18.000 +0.035/+0.056 | 20.000 +/-0.127 | 22.00 | 2.00 | BF0140-0180-0200-BS2220LT |
| 14.000 (0.551") +0.025/+0.051 (mm) | 18.000 +0.035/+0.056 | 22.000 +/-0.127 | 22.00 | 2.00 | BF0140-0180-0220-BS2220LT |
| 14.000 (0.551") +0.005/+0.030 (mm) | 20.000 +0.035/+0.060 | 10.000 +/-0.127 | 26.00 | 3.00 | BF0140-0200-0100-BS2630LH |
| 14.000 (0.551") +0.005/+0.030 (mm) | 20.000 +0.035/+0.060 | 14.000 +/-0.127 | 26.00 | 3.00 | BF0140-0200-0140-BS2630LH |
| 14.000 (0.551") +0.025/+0.051 (mm) | 20.000 +0.035/+0.056 | 18.000 +/-0.127 | 26.00 | 3.00 | BF0140-0200-0180-BS2630LT |
| 14.000 (0.551") +0.025/+0.051 (mm) | 20.000 +0.035/+0.056 | 20.000 +/-0.127 | 26.00 | 3.00 | BF0140-0200-0200-BS2630TT |
| 14.000 (0.551") +0.025/+0.051 (mm) | 20.000 +0.035/+0.056 | 22.000 +/-0.127 | 26.00 | 3.00 | BF0140-0200-0220-BS2630LT |
| 14.000 (0.551") +0.025/+0.051 (mm) | 20.000 +0.035/+0.056 | 28.000 +/-0.127 | 26.00 | 3.00 | BF0140-0200-0280-BS2630LT |
| 14.288 (0.563") +0.038/+0.064 (mm) | 19.050 +0.051/+0.076 | 12.700 +/-0.127 | 25.40 | 3.18 | BF0143-0191-0127-BS2532HH |
| 14.288 (0.563") +0.038/+0.064 (mm) | 19.050 +0.051/+0.076 | 19.050 +/-0.127 | 25.40 | 3.18 | BF0143-0191-0191-BS2532HH |
| 14.288 (0.563") +0.038/+0.063 (mm) | 19.050 +0.051/+0.076 | 25.400 +/-0.191 | 25.40 | 3.18 | BF0143-0191-0254-BS2532HH |
| 15.000 (0.591") +0.005/+0.030 (mm) | 19.000 +0.035/+0.060 | 15.000 +/-0.120 | 23.00 | 2.00 | BF0150-0190-0150-BS2320LH |
| 15.000 (0.591") +0.005/+0.030 (mm) | 19.000 +0.035/+0.060 | 16.000 +/-0.120 | 23.00 | 2.00 | BF0150-0190-0160-BS2320LH |



Stocked or Short Delivery



Usually Available Short Delivery



Long delivery or not in current production

* Large Minimum Quantities

** Available only while stock lasts

Bushes - Flanged

| Nominal ID (d) mm (inches) | Nominal OD (D) mm | Length (S) mm | Flange OD (D1) mm | Flange Thickness (S1) mm | Part Number |
|---------------------------------------|-------------------------|--------------------|----------------------|-----------------------------|----------------------------------|
| 15.000 (0.591") +0.005/+0.030 (mm) | 19.000 +0.035/+0.060 | 20.000 +/-0.120 | 23.00 | 2.00 | BF0150-0190-0200-BS2320LH |
| 15.000 (0.591") +0.005/+0.030 (mm) | 19.000 +0.035/+0.060 | 25.000 +/-0.120 | 23.00 | 2.00 | BF0150-0190-0250-BS2320LH |
| 15.000 (0.591") +0.005/+0.030 (mm) | 21.000 +0.035/+0.060 | 10.000 +/-0.127 | 27.00 | 3.00 | BF0150-0210-0100-BS2730LT |
| 15.000 (0.591") +0.005/+0.030 (mm) | 21.000 +0.035/+0.060 | 15.000 +/-0.127 | 27.00 | 3.00 | BF0150-0210-0150-BS2730LH |
| 15.000 (0.591") +0.005/+0.030 (mm) | 21.000 +0.035/+0.060 | 16.000 +/-0.120 | 27.00 | 3.00 | BF0150-0210-0160-BS2730LH |
| 15.000 (0.591") +0.005/+0.030 (mm) | 21.000 +0.035/+0.060 | 20.000 +/-0.127 | 27.00 | 3.00 | BF0150-0210-0200-BS2730LT |
| 15.000 (0.591") +0.005/+0.030 (mm) | 21.000 +0.035/+0.060 | 25.000 +/-0.127 | 27.00 | 3.00 | BF0150-0210-0250-BS2730LH |
| 15.000 (0.591") +0.005/+0.030 (mm) | 21.000 +0.035/+0.060 | 32.000 +/-0.120 | 27.00 | 3.00 | BF0150-0210-0320-BS2730LH |
| 15.000 (0.591") +0.005/+0.030 (mm) | 22.000 +0.035/+0.060 | 12.000 +/-0.120 | 28.00 | 3.00 | BF0150-0220-0120-BS2830LH |
| 15.000 (0.591") +0.005/+0.030 (mm) | 22.000 +0.035/+0.060 | 15.000 +/-0.120 | 28.00 | 3.00 | BF0150-0220-0150-BS2830LH |
| 15.875 (0.625") +0.025/+0.051 (mm) | 19.050 +0.063/+0.089 | 5.842 +/-0.127 | 22.23 | 3.68 | BF0159-0191-0058-BS2237TH |
| 15.875 (0.625") +0.025/+0.051 (mm) | 19.050 +0.063/+0.089 | 9.423 +/-0.127 | 25.17 | 1.60 | BF0159-0191-0094-BS2516TH |
| 15.875 (0.625") +0.038/+0.063 (mm) | 19.050 +0.038/+0.063 | 12.700 +/-0.127 | 22.23 | 1.59 | BF0159-0191-0127-BS2216HH |
| 15.875 (0.625") +0.025/+0.051 (mm) | 19.050 +0.051/+0.076 | 12.700 +/-0.127 | 25.40 | 2.38 | BF0159-0191-0127-BS2524TH |
| 15.875 (0.625") +0.000/+0.025 (mm) | 19.050 +0.051/+0.076 | 12.700 +/-0.191 | 25.40 | 3.18 | BF0159-0191-0127-BS2532LH |
| 15.875 (0.625") +0.025/+0.051 (mm) | 19.050 +0.035/+0.056 | 12.700 +/-0.127 | 28.58 | 2.39 | BF0159-0191-0127-BS2924TT |
| 15.875 (0.625") +0.012/+0.038 (mm) | 19.050 +0.038/+0.063 | 15.875 +/-0.127 | 25.40 | 2.38 | BF0159-0191-0159-BS2524LH |
| 15.875 (0.625") +0.025/+0.051 (mm) | 19.050 +0.051/+0.076 | 15.875 +/-0.127 | 25.40 | 2.38 | BF0159-0191-0159-BS2524TH |
| 15.875 (0.625") +0.000/+0.025 (mm) | 19.050 +0.051/+0.076 | 15.875 +/-0.191 | 25.40 | 3.18 | BF0159-0191-0159-BS2532LH |
| 15.875 (0.625") +0.025/+0.051 (mm) | 19.050 +0.051/+0.076 | 15.875 +/-0.127 | 25.40 | 3.18 | BF0159-0191-0159-BS2532TH |
| 15.875 (0.625") +0.025/+0.051 (mm) | 19.050 +0.063/+0.089 | 16.002 +/-0.127 | 25.17 | 1.60 | BF0159-0191-0160-BS2516TH |
| 15.875 (0.625") +0.012/+0.038 (mm) | 19.050 +0.038/+0.063 | 19.050 +/-0.127 | 25.40 | 2.38 | BF0159-0191-0191-BS2524LH |
| 15.875 (0.625") +0.025/+0.051 (mm) | 19.050 +0.051/+0.076 | 19.050 +/-0.127 | 25.40 | 2.38 | BF0159-0191-0191-BS2524TH |
| 15.875 (0.625") +0.000/+0.025 (mm) | 19.050 +0.051/+0.076 | 19.050 +/-0.191 | 25.40 | 3.18 | BF0159-0191-0191-BS2532LH |
| 15.875 (0.625") +0.025/+0.051 (mm) | 19.050 +0.051/+0.076 | 19.050 +/-0.127 | 25.40 | 3.18 | BF0159-0191-0191-BS2532TH |
| 15.875 (0.625") +0.038/+0.063 (mm) | 19.050 +0.038/+0.063 | 25.400 +/-0.127 | 22.23 | 1.59 | BF0159-0191-0254-BS2216HH |
| 15.875 (0.625") +0.012/+0.038 (mm) | 19.050 +0.038/+0.063 | 25.400 +/-0.127 | 25.40 | 2.38 | BF0159-0191-0254-BS2524LH |
| 15.875 (0.625") +0.025/+0.051 (mm) | 19.050 +0.051/+0.076 | 25.400 +/-0.127 | 25.40 | 2.38 | BF0159-0191-0254-BS2524TH |
| 15.875 (0.625") +0.000/+0.025 (mm) | 19.050 +0.051/+0.076 | 25.400 +/-0.127 | 25.40 | 3.18 | BF0159-0191-0254-BS2532LH |
| 15.875 (0.625") +0.025/+0.051 (mm) | 19.050 +0.051/+0.076 | 25.400 +/-0.127 | 25.40 | 3.18 | BF0159-0191-0254-BS2532TH |
| 15.875 (0.625") +0.025/+0.051 (mm) | 19.050 +0.035/+0.056 | 25.400 +/-0.127 | 28.58 | 2.39 | BF0159-0191-0254-BS2924TT |
| 15.875 (0.625") +0.038/+0.063 (mm) | 19.050 +0.038/+0.063 | 28.575 +/-0.127 | 22.23 | 1.59 | BF0159-0191-0286-BS2216HH |
| 15.875 (0.625") +0.012/+0.038 (mm) | 19.050 +0.038/+0.063 | 28.575 +/-0.127 | 25.40 | 2.38 | BF0159-0191-0286-BS2524LH |
| 15.875 (0.625") +0.025/+0.051 (mm) | 19.050 +0.051/+0.076 | 28.575 +/-0.127 | 25.40 | 2.38 | BF0159-0191-0286-BS2524TH |

 Stocked or Short Delivery

 Usually Available Short Delivery

 Long delivery or not in current production

* Large Minimum Quantities

** Available only while stock lasts

Bushes - Flanged

| Nominal ID (d) mm (inches) | Nominal OD (D) mm | Length (S) mm | Flange OD (D1) mm | Flange Thickness (S1) mm | Part Number |
|---------------------------------------|-------------------------|--------------------|----------------------|-----------------------------|----------------------------------|
| 15.875 (0.625") +0.025/+0.051 (mm) | 19.050 +0.051/+0.076 | 28.575 +/-0.127 | 25.40 | 3.18 | BF0159-0191-0286-BS2532TH |
| 15.875 (0.625") +0.012/+0.038 (mm) | 19.050 +0.038/+0.063 | 31.750 +/-0.127 | 25.40 | 2.38 | BF0159-0191-0318-BS2524LH |
| 15.875 (0.625") +0.025/+0.051 (mm) | 19.050 +0.051/+0.076 | 31.750 +/-0.127 | 25.40 | 2.38 | BF0159-0191-0318-BS2524TH |
| 15.875 (0.625") +0.000/+0.025 (mm) | 19.050 +0.051/+0.076 | 31.750 +/-0.127 | 25.40 | 3.18 | BF0159-0191-0318-BS2532LH |
| 15.875 (0.625") +0.025/+0.051 (mm) | 19.050 +0.051/+0.076 | 38.100 +/-0.127 | 25.40 | 2.38 | BF0159-0191-0381-BS2524TH |
| 15.875 (0.625") +0.000/+0.025 (mm) | 20.638 +0.038/+0.063 | 12.700 +/-0.127 | 25.40 | 3.18 | BF0159-0206-0127-BS2532LH |
| 15.875 (0.625") +0.088/+0.114 (mm) | 20.638 +0.051/+0.076 | 12.700 +/-0.127 | 25.40 | 3.18 | BF0159-0206-0127-BS2532HH |
| 15.875 (0.625") +0.025/+0.051 (mm) | 20.638 +0.038/+0.064 | 15.875 +/-0.127 | 26.99 | 3.97 | BF0159-0206-0159-BS2840TH |
| 15.875 (0.625") +0.000/+0.025 (mm) | 20.638 +0.038/+0.063 | 19.050 +/-0.127 | 25.40 | 3.18 | BF0159-0206-0191-BS2532LH |
| 15.875 (0.625") +0.025/+0.051 (mm) | 20.638 +0.076/+0.102 | 19.050 +/-0.127 | 25.40 | 3.18 | BF0159-0206-0191-BS2532TH |
| 15.875 (0.625") +0.051/+0.076 (mm) | 20.638 +0.038/+0.064 | 19.050 +/-0.127 | 25.40 | 3.18 | BF0159-0206-0191-BS2532HH2 |
| 15.875 (0.625") +0.088/+0.114 (mm) | 20.638 +0.051/+0.076 | 19.050 +/-0.127 | 25.40 | 3.18 | BF0159-0206-0191-BS2532HH |
| 15.875 (0.625") +0.025/+0.051 (mm) | 20.638 +0.038/+0.063 | 19.050 +/-0.191 | 26.99 | 3.97 | BF0159-0206-0191-BS2740TH |
| 15.875 (0.625") +0.051/+0.076 (mm) | 20.638 +0.063/+0.089 | 19.050 +/-0.127 | 31.75 | 3.18 | BF0159-0206-0191-BS3232HH |
| 15.875 (0.625") +0.000/+0.025 (mm) | 20.638 +0.038/+0.063 | 25.400 +/-0.127 | 25.40 | 3.18 | BF0159-0206-0254-BS2532LH |
| 15.875 (0.625") +0.025/+0.051 (mm) | 20.638 +0.076/+0.102 | 25.400 +/-0.127 | 25.40 | 3.18 | BF0159-0206-0254-BS2532TH |
| 15.875 (0.625") +0.051/+0.076 (mm) | 20.638 +0.038/+0.064 | 25.400 +/-0.127 | 25.40 | 3.18 | BF0159-0206-0254-BS2532HH2 |
| 15.875 (0.625") +0.088/+0.114 (mm) | 20.638 +0.051/+0.076 | 25.400 +/-0.127 | 25.40 | 3.18 | BF0159-0206-0254-BS2532HH |
| 15.875 (0.625") -0.025/+0.000 (mm) | 20.638 +0.038/+0.063 | 25.400 +/-0.127 | 25.40 | 3.18 | BF0159-0206-0254-BS2532UH |
| 15.875 (0.625") +0.025/+0.051 (mm) | 20.638 +0.038/+0.063 | 25.400 +/-0.127 | 26.99 | 3.97 | BF0159-0206-0254-BS2740TH |
| 15.875 (0.625") +0.025/+0.051 (mm) | 20.638 +0.076/+0.102 | 31.750 +/-0.127 | 25.40 | 3.18 | BF0159-0206-0318-BS2532TH |
| 15.875 (0.625") +0.051/+0.076 (mm) | 20.638 +0.038/+0.064 | 31.750 +/-0.127 | 25.40 | 3.18 | BF0159-0206-0318-BS2532HH |
| 15.875 (0.625") -0.025/+0.000 (mm) | 20.638 +0.038/+0.063 | 31.750 +/-0.127 | 25.40 | 3.18 | BF0159-0206-0318-BS2532UH |
| 15.875 (0.625") +0.025/+0.051 (mm) | 20.638 +0.038/+0.063 | 31.750 +/-0.127 | 26.99 | 3.97 | BF0159-0206-0318-BS2740TH |
| 15.875 (0.625") +0.025/+0.051 (mm) | 20.638 +0.038/+0.063 | 36.512 +/-0.127 | 26.99 | 3.97 | BF0159-0206-0365-BS2740TH |
| 15.875 (0.625") +0.051/+0.076 (mm) | 20.638 +0.063/+0.089 | 36.512 +/-0.127 | 31.75 | 3.18 | BF0159-0206-0365-BS3232HH |
| 15.875 (0.625") +0.025/+0.051 (mm) | 20.638 +0.076/+0.102 | 38.100 +/-0.127 | 25.40 | 3.18 | BF0159-0206-0381-BS2532TH |
| 15.875 (0.625") +0.051/+0.076 (mm) | 20.638 +0.038/+0.064 | 38.100 +/-0.127 | 25.40 | 3.18 | BF0159-0206-0381-BS2532HH |
| 15.875 (0.625") +0.025/+0.051 (mm) | 20.638 +0.038/+0.063 | 38.100 +/-0.127 | 26.99 | 3.97 | BF0159-0206-0381-BS2740TH |
| 15.875 (0.625") +0.025/+0.051 (mm) | 20.638 +0.038/+0.063 | 50.800 +/-0.190 | 26.99 | 3.97 | BF0159-0206-0508-BS2740TH |
| 15.875 (0.625") +0.025/+0.051 (mm) | 22.225 +0.076/+0.102 | 12.700 +/-0.127 | 28.58 | 3.18 | BF0159-0222-0127-BS2932TH |
| 15.875 (0.625") +0.025/+0.051 (mm) | 22.225 +0.035/+0.056 | 12.700 +/-0.127 | 31.75 | 3.18 | BF0159-0222-0127-BS3232TT |
| 15.875 (0.625") +0.025/+0.051 (mm) | 22.225 +0.025/+0.051 | 15.875 +/-0.127 | 25.40 | 3.18 | BF0159-0222-0159-BS2532TT |
| 15.875 (0.625") +0.025/+0.051 (mm) | 22.225 +0.076/+0.102 | 15.875 +/-0.127 | 28.58 | 3.18 | BF0159-0222-0159-BS2932TH |



Stocked or Short Delivery



Usually Available Short Delivery



Long delivery or not in current production

* Large Minimum Quantities

** Available only while stock lasts

Bushes - Flanged

| Nominal ID (d) mm (inches) | Nominal OD (D) mm | Length (S) mm | Flange OD (D1) mm | Flange Thickness (S1) mm | Part Number |
|---------------------------------------|-------------------------|--------------------|----------------------|-----------------------------|-------------------------------------|
| 15.875 (0.625") +0.051/+0.076 (mm) | 22.225 +0.051/+0.076 | 15.875 +/-0.127 | 28.58 | 3.18 | BF0159-0222-0159-BS2932HH |
| 15.875 (0.625") +0.025/+0.051 (mm) | 22.225 +0.051/+0.076 | 15.875 +/-0.127 | 28.58 | 3.97 | BF0159-0222-0159-BS2940TH |
| 15.875 (0.625") +0.025/+0.051 (mm) | 22.225 +0.025/+0.051 | 19.050 +/-0.127 | 25.40 | 3.18 | BF0159-0222-0191-BS2532TT |
| 15.875 (0.625") +0.025/+0.051 (mm) | 22.225 +0.076/+0.102 | 19.050 +/-0.127 | 28.58 | 3.18 | BF0159-0222-0191-BS2932TH |
| 15.875 (0.625") +0.051/+0.076 (mm) | 22.225 +0.051/+0.076 | 19.050 +/-0.127 | 28.58 | 3.18 | BF0159-0222-0191-BS2932HH |
| 15.875 (0.625") +0.025/+0.051 (mm) | 22.225 +0.051/+0.076 | 19.050 +/-0.127 | 28.58 | 3.97 | BF0159-0222-0191-BS2940TH |
| 15.875 (0.625") +0.025/+0.051 (mm) | 22.225 +0.035/+0.056 | 19.050 +/-0.127 | 31.75 | 3.18 | BF0159-0222-0191-BS3232TT |
| 15.875 (0.625") +0.025/+0.051 (mm) | 22.225 +0.025/+0.051 | 25.400 +/-0.127 | 25.40 | 3.18 | BF0159-0222-0254-BS2532TT |
| 15.875 (0.625") +0.025/+0.051 (mm) | 22.225 +0.051/+0.076 | 25.400 +/-0.127 | 28.58 | 3.18 | BF0159-0222-0254-BS2932TH |
| 15.875 (0.625") +0.051/+0.076 (mm) | 22.225 +0.051/+0.076 | 25.400 +/-0.127 | 28.58 | 3.18 | BF0159-0222-0254-BS2932HH |
| 15.875 (0.625") +0.025/+0.051 (mm) | 22.225 +0.051/+0.076 | 25.400 +/-0.191 | 28.58 | 3.97 | BF0159-0222-0254-BS2940TH |
| 15.875 (0.625") +0.025/+0.051 (mm) | 22.225 +0.035/+0.056 | 25.400 +/-0.127 | 31.75 | 3.18 | ** BF0159-0222-0254-BS3232TT |
| 15.875 (0.625") +0.025/+0.051 (mm) | 22.225 +0.025/+0.051 | 31.750 +/-0.127 | 25.40 | 3.18 | BF0159-0222-0318-BS2532TT |
| 15.875 (0.625") +0.025/+0.051 (mm) | 22.225 +0.076/+0.102 | 31.750 +/-0.127 | 28.58 | 3.18 | BF0159-0222-0318-BS2832TH |
| 15.875 (0.625") +0.051/+0.076 (mm) | 22.225 +0.051/+0.076 | 31.750 +/-0.127 | 28.58 | 3.18 | BF0159-0222-0318-BS2832HH |
| 15.875 (0.625") +0.051/+0.076 (mm) | 22.225 +0.051/+0.076 | 38.100 +/-0.127 | 28.58 | 3.18 | BF0159-0222-0381-BS2932HH |
| 15.875 (0.625") +0.025/+0.051 (mm) | 22.225 +0.051/+0.076 | 44.450 +/-0.190 | 28.58 | 3.97 | BF0159-0222-0445-BS2940TH |
| 15.875 (0.625") +0.025/+0.051 (mm) | 25.400 +0.051/+0.076 | 19.050 +/-0.127 | 31.75 | 3.97 | BF0159-0254-0191-BS3240TH |
| 15.875 (0.625") +0.025/+0.051 (mm) | 25.400 +0.051/+0.076 | 25.400 +/-0.127 | 31.75 | 3.97 | BF0159-0254-0254-BS3240TH |
| 15.875 (0.625") +0.025/+0.051 (mm) | 25.400 +0.051/+0.076 | 25.400 +/-0.127 | 31.75 | 4.76 | BF0159-0254-0254-BS3250TH |
| 15.875 (0.625") +0.025/+0.051 (mm) | 25.400 +0.076/+0.102 | 25.400 +/-0.127 | 31.75 | 4.76 | BF0159-0254-0254-BS3250TH2 |
| 16.000 (0.630") +0.005/+0.030 (mm) | 20.000 +0.035/+0.060 | 12.000 +/-0.120 | 24.00 | 2.00 | BF0160-0200-0120-BS2420LT |
| 16.000 (0.630") +0.005/+0.030 (mm) | 20.000 +0.035/+0.060 | 16.000 +/-0.120 | 24.00 | 2.00 | BF0160-0200-0160-BS2420LT |
| 16.000 (0.630") +0.025/+0.051 (mm) | 20.000 +0.035/+0.056 | 16.000 +/-0.127 | 27.00 | 3.00 | BF0160-0200-0160-BS2730TT |
| 16.000 (0.630") +0.005/+0.030 (mm) | 20.000 +0.035/+0.060 | 20.000 +/-0.120 | 24.00 | 2.00 | BF0160-0200-0200-BS2420LT |
| 16.000 (0.630") +0.025/+0.051 (mm) | 20.000 +0.035/+0.056 | 20.000 +/-0.127 | 27.00 | 3.00 | BF0160-0200-0200-BS2730TT |
| 16.000 (0.630") +0.005/+0.030 (mm) | 20.000 +0.035/+0.060 | 25.000 +/-0.120 | 24.00 | 2.00 | BF0160-0200-0250-BS2420LT |
| 16.000 (0.630") +0.025/+0.051 (mm) | 20.000 +0.035/+0.056 | 25.000 +/-0.127 | 27.00 | 3.00 | BF0160-0200-0250-BS2730TT |
| 16.000 (0.630") +0.005/+0.030 (mm) | 22.000 +0.035/+0.060 | 12.000 +/-0.127 | 28.00 | 3.00 | BF0160-0220-0120-BS2830LT |
| 16.000 (0.630") +0.005/+0.030 (mm) | 22.000 +0.035/+0.060 | 16.000 +/-0.127 | 28.00 | 3.00 | BF0160-0220-0160-BS2830LT |
| 16.000 (0.630") +0.005/+0.030 (mm) | 22.000 +0.035/+0.060 | 20.000 +/-0.127 | 28.00 | 3.00 | BF0160-0220-0200-BS2830LT |
| 16.000 (0.630") +0.005/+0.030 (mm) | 22.000 +0.035/+0.060 | 25.000 +/-0.127 | 28.00 | 3.00 | BF0160-0220-0250-BS2830LT |
| 16.000 (0.630") +0.005/+0.030 (mm) | 22.000 +0.035/+0.060 | 32.000 +/-0.120 | 28.00 | 3.00 | BF0160-0220-0320-BS2830LT |
| 18.000 (0.709") +0.005/+0.030 (mm) | 22.000 +0.035/+0.060 | 18.000 +/-0.120 | 26.00 | 2.00 | BF0180-0220-0180-BS2620LT |



Stocked or Short Delivery



Usually Available Short Delivery



Long delivery or not in current production

* Large Minimum Quantities

** Available only while stock lasts

Bushes - Flanged

| Nominal ID (d) mm (inches) | Nominal OD (D) mm | Length (S) mm | Flange OD (D1) mm | Flange Thickness (S1) mm | Part Number |
|---------------------------------------|-------------------------|--------------------|----------------------|-----------------------------|----------------------------------|
| 18.000 (0.709") +0.005/+0.030 (mm) | 22.000 +0.035/+0.060 | 20.000 +/-0.120 | 26.00 | 2.00 | BF0180-0220-0200-BS2620LT |
| 18.000 (0.709") +0.005/+0.030 (mm) | 22.000 +0.035/+0.060 | 22.000 +/-0.120 | 26.00 | 2.00 | BF0180-0220-0220-BS2620LT |
| 18.000 (0.709") +0.005/+0.030 (mm) | 24.000 +0.035/+0.060 | 12.000 +/-0.127 | 30.00 | 3.00 | BF0180-0240-0120-BS3030LT |
| 18.000 (0.709") +0.005/+0.030 (mm) | 24.000 +0.035/+0.060 | 18.000 +/-0.127 | 30.00 | 3.00 | BF0180-0240-0180-BS3030LT |
| 18.000 (0.709") +0.005/+0.030 (mm) | 24.000 +0.035/+0.060 | 22.000 +/-0.127 | 30.00 | 3.00 | BF0180-0240-0220-BS3030LT |
| 18.000 (0.709") +0.005/+0.030 (mm) | 24.000 +0.035/+0.060 | 28.000 +/-0.127 | 30.00 | 3.00 | BF0180-0240-0280-BS3030LT |
| 18.000 (0.709") +0.005/+0.030 (mm) | 24.000 +0.035/+0.060 | 30.000 +/-0.127 | 30.00 | 3.00 | BF0180-0240-0300-BS3030LT |
| 19.050 (0.750") +0.000/+0.025 (mm) | 22.225 +0.025/+0.051 | 12.700 +/-0.127 | 25.40 | 1.59 | BF0191-0222-0127-BS2516LT |
| 19.050 (0.750") +0.025/+0.051 (mm) | 22.225 +0.076/+0.102 | 12.700 +/-0.127 | 28.58 | 3.18 | BF0191-0222-0127-BS2932TH |
| 19.050 (0.750") +0.051/+0.076 (mm) | 22.225 +0.051/+0.076 | 12.700 +/-0.127 | 28.58 | 3.18 | BF0191-0222-0127-BS2932HH |
| 19.050 (0.750") +0.025/+0.051 (mm) | 22.225 +0.076/+0.102 | 19.050 +/-0.127 | 28.58 | 3.18 | BF0191-0222-0191-BS2932TH |
| 19.050 (0.750") +0.051/+0.076 (mm) | 22.225 +0.051/+0.076 | 19.050 +/-0.127 | 28.58 | 3.18 | BF0191-0222-0191-BS2932HH |
| 19.050 (0.750") +0.025/+0.051 (mm) | 22.225 +0.051/+0.076 | 19.050 +/-0.127 | 28.58 | 3.97 | BF0191-0222-0191-BS2940TH |
| 19.050 (0.750") +0.000/+0.025 (mm) | 22.225 +0.025/+0.051 | 25.400 +/-0.127 | 25.40 | 1.59 | BF0191-0222-0254-BS2516LT |
| 19.050 (0.750") +0.051/+0.076 (mm) | 22.225 +0.051/+0.076 | 25.400 +/-0.127 | 28.58 | 3.18 | BF0191-0222-0254-BS2932HH |
| 19.050 (0.750") +0.025/+0.051 (mm) | 22.225 +0.051/+0.076 | 25.400 +/-0.191 | 28.58 | 3.97 | BF0191-0222-0254-BS2940TH |
| 19.050 (0.750") +0.025/+0.051 (mm) | 22.225 +0.051/+0.076 | 31.750 +/-0.127 | 28.58 | 3.97 | BF0191-0222-0318-BS2940TH |
| 19.050 (0.750") +0.051/+0.076 (mm) | 22.225 +0.051/+0.076 | 38.100 +/-0.127 | 28.58 | 3.18 | BF0191-0222-0381-BS2932HH |
| 19.050 (0.750") +0.025/+0.051 (mm) | 23.813 +0.076/+0.102 | 14.288 +/-0.127 | 31.75 | 3.18 | BF0191-0238-0143-BS3232TH |
| 19.050 (0.750") +0.051/+0.076 (mm) | 23.813 -0.013/+0.012 | 14.288 +/-0.127 | 33.34 | 3.18 | BF0191-0238-0143-BS3332HU |
| 19.050 (0.750") -0.013/+0.013 (mm) | 23.813 +0.038/+0.063 | 19.050 +/-0.127 | 28.575 | 3.18 | BF0191-0238-0191-BS2832UH |
| 19.050 (0.750") +0.051/+0.076 (mm) | 23.813 -0.013/+0.012 | 19.050 +/-0.127 | 28.58 | 2.38 | BF0191-0238-0191-BS2924HU |
| 19.050 (0.750") +0.025/+0.051 (mm) | 23.813 +0.076/+0.102 | 19.050 +/-0.127 | 31.75 | 3.18 | BF0191-0238-0191-BS3232TH |
| 19.050 (0.750") +0.051/+0.076 (mm) | 23.813 +0.038/+0.064 | 19.050 +/-0.127 | 31.75 | 3.18 | BF0191-0238-0191-BS3232HH |
| 19.050 (0.750") -0.013/+0.013 (mm) | 23.813 +0.038/+0.063 | 25.400 +/-0.127 | 28.575 | 3.18 | BF0191-0238-0254-BS2832UH |
| 19.050 (0.750") +0.025/+0.051 (mm) | 23.813 +0.038/+0.063 | 25.400 +/-0.191 | 30.16 | 3.97 | BF0191-0238-0254-BS3040TH |
| 19.050 (0.750") +0.025/+0.051 (mm) | 23.813 +0.076/+0.102 | 25.400 +/-0.127 | 31.75 | 3.18 | BF0191-0238-0254-BS3232TH |
| 19.050 (0.750") +0.051/+0.076 (mm) | 23.813 +0.038/+0.064 | 25.400 +/-0.127 | 31.75 | 3.18 | BF0191-0238-0254-BS3232HH |
| 19.050 (0.750") +0.051/+0.076 (mm) | 23.813 +0.051/+0.076 | 28.575 +/-0.127 | 29.85 | 3.18 | BF0191-0238-0286-BS3032HH |
| 19.050 (0.750") +0.025/+0.051 (mm) | 23.813 +0.076/+0.102 | 28.575 +/-0.127 | 31.75 | 3.18 | BF0191-0238-0286-BS3232TH |
| 19.050 (0.750") +0.051/+0.076 (mm) | 23.813 +0.038/+0.064 | 28.575 +/-0.127 | 31.75 | 3.18 | BF0191-0238-0286-BS3232HH |
| 19.050 (0.750") +0.025/+0.051 (mm) | 23.813 +0.038/+0.064 | 31.750 +/-0.127 | 30.16 | 3.97 | BF0191-0238-0318-BS3040TH |
| 19.050 (0.750") +0.025/+0.051 (mm) | 23.813 +0.076/+0.102 | 31.750 +/-0.127 | 31.75 | 3.18 | BF0191-0238-0318-BS3232TH |
| 19.050 (0.750") +0.051/+0.076 (mm) | 23.813 +0.038/+0.064 | 31.750 +/-0.127 | 31.75 | 3.18 | BF0191-0238-0318-BS3232HH |



Stocked or Short Delivery



Usually Available Short Delivery



Long delivery or not in current production

* Large Minimum Quantities

** Available only while stock lasts

Bushes - Flanged

| Nominal ID (d) mm (inches) | Nominal OD (D) mm | Length (S) mm | Flange OD (D1) mm | Flange Thickness (S1) mm | Part Number |
|---------------------------------------|-------------------------|--------------------|----------------------|-----------------------------|-------------------------------------|
| 19.050 (0.750") +0.051/+0.076 (mm) | 23.813 -0.013/+0.012 | 31.750 +/-0.127 | 33.34 | 3.18 | BF0191-0238-0318-BS3332HU |
| 19.050 (0.750") +0.025/+0.051 (mm) | 23.813 +0.038/+0.063 | 38.100 +/-0.127 | 30.16 | 3.97 | BF0191-0238-0381-BS3040TH |
| 19.050 (0.750") +0.025/+0.051 (mm) | 23.813 +0.063/+0.089 | 38.100 | 30.160 | 3.97 | BF0191-0238-0381-BS3040TH2 |
| 19.050 (0.750") +0.025/+0.051 (mm) | 23.813 +0.076/+0.102 | 38.100 +/-0.127 | 31.75 | 3.18 | BF0191-0238-0381-BS3232TH |
| 19.050 (0.750") +0.051/+0.076 (mm) | 23.813 +0.038/+0.064 | 38.100 +/-0.127 | 31.75 | 3.18 | BF0191-0238-0381-BS3232HH |
| 19.050 (0.750") +0.051/+0.076 (mm) | 23.813 -0.013/+0.012 | 39.688 +/-0.190 | 33.34 | 3.18 | BF0191-0238-0397-BS3332HU |
| 19.050 (0.750") +0.051/+0.076 (mm) | 25.400 +0.051/+0.076 | 12.700 +/-0.127 | 28.58 | 3.18 | BF0191-0254-0127-BS2932HH |
| 19.050 (0.750") -0.013/+0.013 (mm) | 25.400 +0.025/+0.051 | 12.700 +/-0.127 | 36.51 | 3.18 | BF0191-0254-0127-BS3732UT |
| 19.050 (0.750") +0.051/+0.076 (mm) | 25.400 +0.051/+0.076 | 15.875 +/-0.127 | 28.58 | 3.18 | BF0191-0254-0159-BS2932HH |
| 19.050 (0.750") +0.025/+0.051 (mm) | 25.400 +0.051/+0.076 | 15.875 +/-0.127 | 31.75 | 3.97 | BF0191-0254-0159-BS3240TH |
| 19.050 (0.750") +0.025/+0.051 (mm) | 25.400 +0.076/+0.102 | 15.875 +/-0.190 | 31.75 | 4.76 | BF0191-0254-0159-BS3250TH |
| 19.050 (0.750") -0.013/+0.013 (mm) | 25.400 +0.025/+0.051 | 15.875 +/-0.127 | 36.51 | 3.18 | BF0191-0254-0159-BS3732UT |
| 19.050 (0.750") +0.051/+0.076 (mm) | 25.400 +0.051/+0.076 | 19.050 +/-0.127 | 28.58 | 3.18 | BF0191-0254-0191-BS2932HH |
| 19.050 (0.750") +0.025/+0.051 (mm) | 25.400 +0.051/+0.076 | 19.050 +/-0.191 | 31.75 | 3.97 | BF0191-0254-0191-BS3240TH |
| 19.050 (0.750") +0.025/+0.051 (mm) | 25.400 +0.076/+0.102 | 19.050 +/-0.190 | 31.75 | 4.76 | BF0191-0254-0191-BS3250TH |
| 19.050 (0.750") +0.025/+0.051 (mm) | 25.400 +0.025/+0.051 | 19.050 +/-0.127 | 33.34 | 3.18 | BF0191-0254-0191-BS3332TT |
| 19.050 (0.750") +0.025/+0.051 (mm) | 25.400 +0.035/+0.056 | 19.050 +/-0.127 | 34.93 | 3.18 | BF0191-0254-0191-BS3532TT |
| 19.050 (0.750") +0.000/+0.025 (mm) | 25.400 +0.025/+0.051 | 19.050 +/-0.127 | 38.10 | 3.18 | BF0191-0254-0191-BS3832LT |
| 19.050 (0.750") +0.051/+0.076 (mm) | 25.400 +0.051/+0.076 | 25.400 +/-0.127 | 28.58 | 3.18 | BF0191-0254-0254-BS2932HH |
| 19.050 (0.750") +0.025/+0.051 (mm) | 25.400 +0.051/+0.076 | 25.400 +/-0.191 | 31.75 | 3.97 | BF0191-0254-0254-BS3240TH |
| 19.050 (0.750") +0.025/+0.051 (mm) | 25.400 +0.076/+0.102 | 25.400 +/-0.190 | 31.75 | 4.76 | BF0191-0254-0254-BS3250TH |
| 19.050 (0.750") +0.025/+0.051 (mm) | 25.400 +0.025/+0.051 | 25.400 +/-0.127 | 33.34 | 3.18 | BF0191-0254-0254-BS3332TT |
| 19.050 (0.750") +0.025/+0.051 (mm) | 25.400 +0.035/+0.056 | 25.400 +/-0.127 | 34.93 | 3.18 | ** BF0191-0254-0254-BS3532TT |
| 19.050 (0.750") -0.013/+0.013 (mm) | 25.400 +0.025/+0.051 | 25.400 | 36.51 | 3.18 | BF0191-0254-0254-BS3732UT |
| 19.050 (0.750") +0.000/+0.025 (mm) | 25.400 +0.025/+0.051 | 25.400 +/-0.127 | 38.10 | 3.18 | BF0191-0254-0254-BS3832LT |
| 19.050 (0.750") +0.051/+0.076 (mm) | 25.400 +0.051/+0.076 | 28.575 +/-0.127 | 28.58 | 3.18 | BF0191-0254-0286-BS2932HH |
| 19.050 (0.750") +0.025/+0.051 (mm) | 25.400 +0.076/+0.102 | 28.575 +/-0.190 | 31.75 | 4.76 | BF0191-0254-0286-BS3250TH |
| 19.050 (0.750") -0.013/+0.013 (mm) | 25.400 +0.025/+0.051 | 28.575 +/-0.127 | 36.51 | 3.18 | BF0191-0254-0286-BS3732UT |
| 19.050 (0.750") +0.051/+0.076 (mm) | 25.400 +0.051/+0.076 | 31.750 +/-0.127 | 28.58 | 3.18 | BF0191-0254-0318-BS2932HH |
| 19.050 (0.750") +0.025/+0.051 (mm) | 25.400 +0.051/+0.076 | 31.750 +/-0.127 | 31.75 | 3.97 | BF0191-0254-0318-BS3240TH |
| 19.050 (0.750") +0.025/+0.051 (mm) | 25.400 +0.076/+0.102 | 31.750 +/-0.190 | 31.75 | 4.76 | BF0191-0254-0318-BS3250TH |
| 19.050 (0.750") +0.025/+0.051 (mm) | 25.400 +0.035/+0.056 | 31.750 +/-0.127 | 34.93 | 3.18 | BF0191-0254-0318-BS3532TT |
| 19.050 (0.750") +0.000/+0.025 (mm) | 25.400 +0.025/+0.051 | 31.750 +/-0.127 | 38.10 | 3.18 | BF0191-0254-0318-BS3832LT |
| 19.050 (0.750") +0.051/+0.076 (mm) | 25.400 +0.051/+0.076 | 38.100 +/-0.127 | 28.58 | 3.18 | BF0191-0254-0381-BS2932HH |



Stocked or Short Delivery



Usually Available Short Delivery



Long delivery or not in current production

* Large Minimum Quantities

** Available only while stock lasts

Bushes - Flanged

| Nominal ID (d) mm (inches) | Nominal OD (D) mm | Length (S) mm | Flange OD (D1) mm | Flange Thickness (S1) mm | Part Number |
|---------------------------------------|-------------------------|--------------------|----------------------|-----------------------------|----------------------------------|
| 19.050 (0.750") +0.025/+0.051 (mm) | 25.400 +0.051/+0.076 | 38.100 +/-0.127 | 31.75 | 3.97 | BF0191-0254-0381-BS3240TH |
| 19.050 (0.750") +0.025/+0.051 (mm) | 25.400 +0.076/+0.102 | 38.100 +/-0.190 | 31.75 | 4.76 | BF0191-0254-0381-BS3250TH |
| 19.050 (0.750") +0.000/+0.025 (mm) | 25.400 +0.025/+0.051 | 38.100 +/-0.127 | 38.10 | 3.18 | BF0191-0254-0381-BS3832LT |
| 19.050 (0.750") +0.025/+0.051 (mm) | 25.400 +0.051/+0.076 | 50.800 +/-0.190 | 31.75 | 3.97 | BF0191-0254-0508-BS3240TH |
| 19.050 (0.750") +0.025/+0.051 (mm) | 26.988 +0.051/+0.076 | 30.163 +/-0.127 | 30.16 | 3.18 | BF0191-0270-0302-BS3032TH |
| 20.000 (0.787") +0.005/+0.030 (mm) | 24.000 +0.035/+0.060 | 12.000 +/-0.127 | 28.00 | 2.00 | BF0200-0240-0120-BS2820LT |
| 20.000 (0.787") +0.005/+0.030 (mm) | 24.000 +0.035/+0.060 | 16.000 +/-0.120 | 28.00 | 2.00 | BF0200-0240-0160-BS2820LT |
| 20.000 (0.787") +0.005/+0.030 (mm) | 24.000 +0.035/+0.060 | 20.000 +/-0.120 | 28.00 | 2.00 | BF0200-0240-0200-BS2820LT |
| 20.000 (0.787") +0.005/+0.030 (mm) | 24.000 +0.035/+0.060 | 25.000 +/-0.120 | 28.00 | 2.00 | BF0200-0240-0250-BS2820LT |
| 20.000 (0.787") +0.005/+0.030 (mm) | 26.000 +0.035/+0.060 | 15.000 +/-0.127 | 32.00 | 3.00 | BF0200-0260-0150-BS3230LT |
| 20.000 (0.787") +0.005/+0.030 (mm) | 26.000 +0.035/+0.060 | 16.000 +/-0.120 | 32.00 | 3.00 | BF0200-0260-0160-BS3230LT |
| 20.000 (0.787") +0.005/+0.030 (mm) | 26.000 +0.035/+0.060 | 20.000 +/-0.127 | 32.00 | 3.00 | BF0200-0260-0200-BS3230LT |
| 20.000 (0.787") +0.005/+0.030 (mm) | 26.000 +0.035/+0.060 | 25.000 +/-0.127 | 32.00 | 3.00 | BF0200-0260-0250-BS3230LT |
| 20.000 (0.787") +0.005/+0.030 (mm) | 26.000 +0.035/+0.060 | 30.000 +/-0.127 | 32.00 | 3.00 | BF0200-0260-0300-BS3230LT |
| 20.000 (0.787") +0.005/+0.030 (mm) | 26.000 +0.035/+0.060 | 32.000 +/-0.120 | 32.00 | 3.00 | BF0200-0260-0320-BS3230LT |
| 22.000 (0.866") +0.005/+0.030 (mm) | 27.000 +0.035/+0.060 | 18.000 +/-0.120 | 32.00 | 2.50 | BF0220-0270-0180-BS3225LT |
| 22.000 (0.866") +0.005/+0.030 (mm) | 27.000 +0.035/+0.060 | 22.000 +/-0.120 | 32.00 | 2.50 | BF0220-0270-0220-BS3225LT |
| 22.000 (0.866") +0.005/+0.030 (mm) | 27.000 +0.035/+0.060 | 28.000 +/-0.120 | 32.00 | 2.50 | BF0220-0270-0280-BS3225LT |
| 22.000 (0.866") +0.005/+0.030 (mm) | 28.000 +0.035/+0.060 | 15.000 +/-0.127 | 34.00 | 3.00 | BF0220-0280-0150-BS3430LT |
| 22.000 (0.866") +0.005/+0.030 (mm) | 28.000 +0.035/+0.060 | 16.000 +/-0.120 | 34.00 | 3.00 | BF0220-0280-0160-BS3430LT |
| 22.000 (0.866") +0.005/+0.030 (mm) | 28.000 +0.035/+0.060 | 20.000 +/-0.120 | 34.00 | 3.00 | BF0220-0280-0200-BS3430LT |
| 22.000 (0.866") +0.005/+0.030 (mm) | 28.000 +0.035/+0.060 | 25.000 +/-0.120 | 34.00 | 3.00 | BF0220-0280-0250-BS3430LT |
| 22.000 (0.866") +0.005/+0.030 (mm) | 28.000 +0.035/+0.060 | 30.000 +/-0.120 | 34.00 | 3.00 | BF0220-0280-0300-BS3430LT |
| 22.000 (0.866") +0.005/+0.030 (mm) | 29.000 +0.035/+0.060 | 18.000 +/-0.120 | 36.00 | 3.50 | BF0220-0290-0180-BS3635LT |
| 22.000 (0.866") +0.005/+0.030 (mm) | 29.000 +0.035/+0.060 | 22.000 +/-0.120 | 36.00 | 3.50 | BF0220-0290-0220-BS3635LT |
| 22.000 (0.866") +0.005/+0.030 (mm) | 29.000 +0.035/+0.060 | 28.000 +/-0.120 | 36.00 | 3.50 | BF0220-0290-0280-BS3635LT |
| 22.000 (0.866") +0.005/+0.030 (mm) | 29.000 +0.035/+0.060 | 36.000 +/-0.120 | 36.00 | 3.50 | BF0220-0290-0360-BS3635LT |
| 22.225 (0.875") +0.025/+0.051 (mm) | 25.400 +0.051/+0.076 | 12.700 +/-0.127 | 31.75 | 3.18 | BF0222-0254-0127-BS3232TH |
| 22.225 (0.875") +0.025/+0.051 (mm) | 25.400 +0.076/+0.102 | 12.700 +/-0.127 | 31.75 | 4.76 | BF0222-0254-0127-BS3248TH |
| 22.225 (0.875") +0.012/+0.038 (mm) | 25.400 +0.051/+0.076 | 15.875 +/-0.127 | 31.75 | 3.18 | BF0222-0254-0159-BS3232LH |
| 22.225 (0.875") +0.025/+0.051 (mm) | 25.400 +0.051/+0.076 | 19.050 +/-0.127 | 31.75 | 3.18 | BF0222-0254-0191-BS3232LH |
| 22.225 (0.875") +0.025/+0.051 (mm) | 25.400 +0.051/+0.076 | 19.050 +/-0.191 | 31.75 | 3.97 | BF0222-0254-0191-BS3240TH |
| 22.225 (0.875") +0.025/+0.051 (mm) | 25.400 +0.076/+0.102 | 19.050 +/-0.127 | 31.75 | 4.76 | BF0222-0254-0191-BS3248TH |
| 22.225 (0.875") +0.013/+0.038 (mm) | 25.400 +0.051/+0.076 | 19.050 | 31.750 | 3.97 | BF0222-0254-0191-BS3240LH |



Stocked or Short Delivery



Usually Available Short Delivery



Long delivery or not in current production

* Large Minimum Quantities

** Available only while stock lasts

Bushes - Flanged

| Nominal ID (d) mm (inches) | Nominal OD (D) mm | Length (S) mm | Flange OD (D1) mm | Flange Thickness (S1) mm | Part Number |
|---------------------------------------|-------------------------|--------------------|----------------------|-----------------------------|----------------------------------|
| 22.225 (0.875") +0.025/+0.051 (mm) | 25.400 +0.051/+0.076 | 25.400 +/-0.127 | 31.75 | 3.18 | BF0222-0254-0254-BS3232TH |
| 22.225 (0.875") +0.025/+0.051 (mm) | 25.400 +0.051/+0.076 | 25.400 +/-0.191 | 31.75 | 3.97 | BF0222-0254-0254-BS3240TH |
| 22.225 (0.875") +0.025/+0.051 (mm) | 25.400 +0.076/+0.102 | 25.400 +/-0.127 | 31.75 | 4.76 | BF0222-0254-0254-BS3248TH |
| 22.225 (0.875") +0.013/+0.038 (mm) | 25.400 +0.051/+0.076 | 25.400 | 31.750 | 3.97 | BF0222-0254-0254-BS3240LH |
| 22.225 (0.875") +0.025/+0.051 (mm) | 25.400 +0.051/+0.076 | 31.750 +/-0.127 | 31.75 | 3.18 | BF0222-0254-0318-BS3232TH |
| 22.225 (0.875") +0.025/+0.051 (mm) | 25.400 +0.051/+0.076 | 31.750 +/-0.127 | 31.75 | 3.97 | BF0222-0254-0318-BS3240TH |
| 22.225 (0.875") +0.025/+0.051 (mm) | 25.400 +0.051/+0.076 | 38.100 +/-0.127 | 31.75 | 3.18 | BF0222-0254-0381-BS3232TH |
| 22.225 (0.875") +0.025/+0.051 (mm) | 28.575 +0.051/+0.076 | 15.875 +/-0.127 | 38.10 | 3.18 | BF0222-0286-0159-BS3832TH |
| 22.225 (0.875") +0.051/+0.076 (mm) | 28.575 +0.051/+0.076 | 15.875 +/-0.127 | 38.10 | 3.18 | BF0222-0286-0159-BS3832HH |
| 22.225 (0.875") +0.025/+0.051 (mm) | 28.575 +0.051/+0.076 | 19.050 +/-0.127 | 38.10 | 3.18 | BF0222-0286-0191-BS3832TH |
| 22.225 (0.875") +0.025/+0.051 (mm) | 28.575 +0.076/+0.102 | 19.050 +/-0.127 | 38.10 | 3.18 | BF0222-0286-0191-BS3832TH2 |
| 22.225 (0.875") +0.051/+0.076 (mm) | 28.575 +0.051/+0.076 | 19.050 +/-0.127 | 38.10 | 3.18 | BF0222-0286-0191-BS3832HH |
| 22.225 (0.875") +0.025/+0.051 (mm) | 28.575 +0.035/+0.056 | 19.050 +/-0.127 | 41.28 | 3.18 | BF0222-0286-0191-BS4132TT |
| 22.225 (0.875") +0.025/+0.051 (mm) | 28.575 +0.051/+0.076 | 25.400 +/-0.191 | 34.93 | 3.97 | BF0222-0286-0254-BS3540TH |
| 22.225 (0.875") +0.025/+0.051 (mm) | 28.575 +0.051/+0.076 | 25.400 +/-0.127 | 38.10 | 3.18 | BF0222-0286-0254-BS3832TH |
| 22.225 (0.875") +0.025/+0.051 (mm) | 28.575 +0.076/+0.102 | 25.400 +/-0.127 | 38.10 | 3.18 | BF0222-0286-0254-BS3832TH2 |
| 22.225 (0.875") +0.051/+0.076 (mm) | 28.575 +0.051/+0.076 | 25.400 +/-0.127 | 38.10 | 3.18 | BF0222-0286-0254-BS3832HH |
| 22.225 (0.875") +0.025/+0.051 (mm) | 28.575 +0.035/+0.056 | 25.400 +/-0.127 | 41.28 | 3.18 | BF0222-0286-0254-BS4132TT |
| 22.225 (0.875") +0.025/+0.051 (mm) | 28.575 +0.051/+0.076 | 31.750 +/-0.127 | 34.93 | 3.97 | BF0222-0286-0318-BS3540TH |
| 22.225 (0.875") +0.025/+0.051 (mm) | 28.575 +0.051/+0.076 | 31.750 +/-0.127 | 38.10 | 3.18 | BF0222-0286-0318-BS3832TH |
| 22.225 (0.875") +0.025/+0.051 (mm) | 28.575 +0.076/+0.102 | 31.750 +/-0.127 | 38.10 | 3.18 | BF0222-0286-0318-BS3832TH2 |
| 22.225 (0.875") +0.051/+0.076 (mm) | 28.575 +0.051/+0.076 | 31.750 +/-0.127 | 38.10 | 3.18 | BF0222-0286-0318-BS3832HH |
| 22.225 (0.875") +0.025/+0.051 (mm) | 28.575 +0.035/+0.056 | 31.750 +/-0.127 | 41.28 | 3.18 | BF0222-0286-0318-BS4132TT |
| 22.225 (0.875") +0.025/+0.051 (mm) | 28.575 +0.051/+0.076 | 38.100 +/-0.127 | 34.93 | 3.97 | BF0222-0286-0381-BS3540TH |
| 22.225 (0.875") +0.025/+0.051 (mm) | 28.575 +0.076/+0.102 | 38.100 +/-0.127 | 38.10 | 3.18 | BF0222-0286-0381-BS3832TH |
| 22.225 (0.875") +0.051/+0.076 (mm) | 28.575 +0.051/+0.076 | 38.100 +/-0.127 | 38.10 | 3.18 | BF0222-0286-0381-BS3832HH |
| 22.225 (0.875") +0.025/+0.051 (mm) | 28.575 +0.035/+0.056 | 38.100 +/-0.127 | 41.28 | 3.18 | BF0222-0286-0381-BS4132TT |
| 22.225 (0.875") +0.025/+0.051 (mm) | 28.575 +0.051/+0.076 | 44.450 +/-0.190 | 38.10 | 3.18 | BF0222-0286-0445-BS3832TH |
| 22.225 (0.875") +0.025/+0.051 (mm) | 28.575 +0.076/+0.102 | 44.450 +/-0.127 | 38.10 | 3.18 | BF0222-0286-0445-BS3832TH2 |
| 22.225 (0.875") +0.051/+0.076 (mm) | 28.575 +0.051/+0.076 | 44.450 +/-0.127 | 38.10 | 3.18 | BF0222-0286-0445-BS3832HH |
| 25.000 (0.984") +0.005/+0.030 (mm) | 30.000 +0.035/+0.060 | 20.000 +/-0.127 | 35.00 | 2.50 | BF0250-0300-0200-BS3525LT |
| 25.000 (0.984") +0.005/+0.030 (mm) | 30.000 +0.035/+0.060 | 20.000 +/-0.127 | 39.00 | 3.50 | BF0250-0300-0200-BS3935LT |
| 25.000 (0.984") +0.005/+0.030 (mm) | 30.000 +0.035/+0.060 | 25.000 +/-0.120 | 35.00 | 2.50 | BF0250-0300-0250-BS3525LT |
| 25.000 (0.984") +0.005/+0.030 (mm) | 30.000 +0.035/+0.060 | 25.000 +/-0.127 | 39.00 | 3.50 | BF0250-0300-0250-BS3935LT |



Stocked or Short Delivery



Usually Available Short Delivery



Long delivery or not in current production

* Large Minimum Quantities

** Available only while stock lasts

Bushes - Flanged

| Nominal ID (d) mm (inches) | Nominal OD (D) mm | Length (S) mm | Flange OD (D1) mm | Flange Thickness (S1) mm | Part Number |
|---------------------------------------|-------------------------|--------------------|----------------------|-----------------------------|----------------------------------|
| 25.000 (0.984") +0.005/+0.030 (mm) | 30.000 +0.035/+0.060 | 30.000 +/-0.120 | 35.00 | 2.50 | BF0250-0300-0300-BS3525LT |
| 25.000 (0.984") +0.005/+0.030 (mm) | 30.000 +0.035/+0.060 | 32.000 +/-0.120 | 35.00 | 2.50 | BF0250-0300-0320-BS3525LT |
| 25.000 (0.984") +0.025/+0.051 (mm) | 30.000 +0.035/+0.056 | 32.000 +/-0.127 | 39.00 | 3.50 | BF0250-0300-0320-BS3935TT |
| 25.000 (0.984") +0.005/+0.030 (mm) | 32.000 +0.035/+0.060 | 20.000 +/-0.120 | 39.00 | 3.50 | BF0250-0320-0200-BS3935LT |
| 25.000 (0.984") +0.005/+0.030 (mm) | 32.000 +0.040/+0.070 | 25.000 +/-0.127 | 39.00 | 3.50 | BF0250-0320-0250-BS3935LT |
| 25.000 (0.984") +0.005/+0.030 (mm) | 32.000 +0.040/+0.070 | 30.000 +/-0.127 | 39.00 | 4.00 | BF0250-0320-0300-BS3940LT |
| 25.000 (0.984") +0.005/+0.030 (mm) | 32.000 +0.040/+0.070 | 32.000 +/-0.120 | 39.00 | 3.50 | BF0250-0320-0320-BS3935LT |
| 25.400 (1.000") +0.000/+0.025 (mm) | 31.750 +0.025/+0.051 | 19.050 +/-0.127 | 38.10 | 3.18 | BF0254-0318-0191-BS3832LT |
| 25.400 (1.000") +0.051/+0.076 (mm) | 31.750 +0.076/+0.102 | 19.050 +/-0.127 | 38.10 | 3.18 | BF0254-0318-0191-BS3832HH |
| 25.400 (1.000") +0.025/+0.051 (mm) | 31.750 +0.051/+0.076 | 19.050 +/-0.191 | 38.10 | 4.76 | BF0254-0318-0191-BS3848TH |
| 25.400 (1.000") +0.025/+0.051 (mm) | 31.750 +0.025/+0.051 | 19.050 +/-0.190 | 41.28 | 3.18 | BF0254-0318-0191-BS4132TT |
| 25.400 (1.000") +0.051/+0.076 (mm) | 31.750 +0.051/+0.076 | 19.050 +/-0.127 | 41.28 | 3.18 | BF0254-0318-0191-BS4132HH |
| 25.400 (1.000") +0.000/+0.025 (mm) | 31.750 +0.051/+0.076 | 19.050 +/-0.190 | 47.63 | 3.18 | BF0254-0318-0191-BS4832LH |
| 25.400 (1.000") +0.025/+0.051 (mm) | 31.750 +0.043/+0.068 | 25.400 +/-0.127 | 38.10 | 3.18 | BF0254-0318-0254-BS3832TH |
| 25.400 (1.000") +0.051/+0.076 (mm) | 31.750 +0.076/+0.102 | 25.400 +/-0.127 | 38.10 | 3.18 | BF0254-0318-0254-BS3832HH |
| 25.400 (1.000") +0.025/+0.051 (mm) | 31.750 +0.051/+0.076 | 25.400 +/-0.127 | 38.10 | 4.76 | BF0254-0318-0254-BS3848TH |
| 25.400 (1.000") +0.051/+0.076 (mm) | 31.750 +0.051/+0.076 | 25.400 +/-0.127 | 41.28 | 3.18 | BF0254-0318-0254-BS4132HH |
| 25.400 (1.000") +0.000/+0.025 (mm) | 31.750 +0.051/+0.076 | 25.400 +/-0.127 | 47.63 | 3.18 | BF0254-0318-0254-BS4832LH |
| 25.400 (1.000") +0.051/+0.076 (mm) | 31.750 +0.076/+0.102 | 31.750 +/-0.127 | 38.10 | 3.18 | BF0254-0318-0318-BS3832HH |
| 25.400 (1.000") +0.025/+0.051 (mm) | 31.750 +0.051/+0.076 | 31.750 +/-0.127 | 38.10 | 4.76 | BF0254-0318-0318-BS3848TH |
| 25.400 (1.000") +0.025/+0.051 (mm) | 31.750 +0.025/+0.051 | 31.750 +/-0.127 | 41.28 | 3.18 | BF0254-0318-0318-BS4132TT |
| 25.400 (1.000") +0.051/+0.076 (mm) | 31.750 +0.051/+0.076 | 31.750 +/-0.127 | 41.28 | 3.18 | BF0254-0318-0318-BS4132HH |
| 25.400 (1.000") +0.000/+0.025 (mm) | 31.750 +0.051/+0.076 | 31.750 +/-0.127 | 47.63 | 3.18 | BF0254-0318-0318-BS4832LH |
| 25.400 (1.000") +0.000/+0.025 (mm) | 31.750 +0.025/+0.051 | 38.100 +/-0.127 | 38.10 | 3.18 | BF0254-0318-0381-BS3832LT |
| 25.400 (1.000") +0.051/+0.076 (mm) | 31.750 +0.076/+0.102 | 38.100 +/-0.127 | 38.10 | 3.18 | BF0254-0318-0381-BS3832HH |
| 25.400 (1.000") +0.025/+0.051 (mm) | 31.750 +0.051/+0.076 | 38.100 +/-0.127 | 38.10 | 3.97 | BF0254-0318-0381-BS3840TH |
| 25.400 (1.000") +0.025/+0.051 (mm) | 31.750 +0.051/+0.076 | 38.100 +/-0.127 | 38.10 | 4.76 | BF0254-0318-0381-BS3848TH |
| 25.400 (1.000") +0.025/+0.051 (mm) | 31.750 +0.025/+0.051 | 38.100 +/-0.127 | 41.28 | 3.18 | BF0254-0318-0381-BS4132TT |
| 25.400 (1.000") +0.051/+0.076 (mm) | 31.750 +0.051/+0.076 | 38.100 +/-0.127 | 41.28 | 3.18 | BF0254-0318-0381-BS4132HH |
| 25.400 (1.000") +0.025/+0.051 (mm) | 31.750 +0.025/+0.051 | 44.450 +/-0.190 | 41.28 | 3.18 | BF0254-0318-0445-BS4132TT |
| 25.400 (1.000") +0.051/+0.076 (mm) | 31.750 +0.051/+0.076 | 44.450 +/-0.127 | 41.28 | 3.18 | BF0254-0318-0445-BS4132HH |
| 25.400 (1.000") +0.025/+0.051 (mm) | 31.750 +0.051/+0.076 | 50.800 +/-0.190 | 38.10 | 4.76 | BF0254-0318-0508-BS3848TH |
| 25.400 (1.000") +0.051/+0.076 (mm) | 31.750 +0.051/+0.076 | 50.800 +/-0.127 | 41.28 | 3.18 | BF0254-0318-0508-BS4132HH |
| 25.400 (1.000") +0.000/+0.025 (mm) | 33.338 +0.063/+0.089 | 31.750 +/-0.127 | 44.45 | 5.56 | BF0254-0333-0318-BS4456LH |

 Stocked or Short Delivery
 Usually Available Short Delivery
 Long delivery or not in current production

* Large Minimum Quantities

** Available only while stock lasts

Bushes - Flanged

| Nominal ID (d) mm (inches) | Nominal OD (D) mm | Length (S) mm | Flange OD (D1) mm | Flange Thickness (S1) mm | Part Number |
|---------------------------------------|-------------------------|--------------------|----------------------|-----------------------------|----------------------------------|
| 25.400 (1.000") +0.000/+0.025 (mm) | 33.338 +0.063/+0.089 | 38.100 +/-0.127 | 44.45 | 5.56 | BF0254-0333-0381-BS4456LH |
| 25.400 (1.000") +0.012/+0.038 (mm) | 33.338 +0.051/+0.076 | 38.100 +/-0.127 | 47.63 | 3.18 | BF0254-0333-0381-BS4832LH |
| 25.400 (1.000") +0.051/+0.076 (mm) | 34.925 +0.051/+0.076 | 19.050 +/-0.127 | 41.28 | 4.76 | BF0254-0349-0191-BS4148HH |
| 25.400 (1.000") +0.051/+0.076 (mm) | 34.925 +0.076/+0.102 | 19.050 +/-0.127 | 41.28 | 4.76 | BF0254-0349-0191-BS4148HH2 |
| 25.400 (1.000") +0.025/+0.051 (mm) | 34.925 +0.051/+0.076 | 25.400 +/-0.191 | 41.28 | 4.76 | BF0254-0349-0254-BS4148TH |
| 25.400 (1.000") +0.051/+0.076 (mm) | 34.925 +0.051/+0.076 | 25.400 +/-0.127 | 41.28 | 4.76 | BF0254-0349-0254-BS4148HH |
| 25.400 (1.000") +0.051/+0.076 (mm) | 34.925 +0.076/+0.102 | 25.400 +/-0.127 | 41.28 | 4.76 | BF0254-0349-0254-BS4148HH2 |
| 25.400 (1.000") +0.025/+0.051 (mm) | 34.925 +0.051/+0.076 | 38.100 +/-0.127 | 41.28 | 4.76 | BF0254-0349-0381-BS4148TH |
| 25.400 (1.000") +0.051/+0.076 (mm) | 34.925 +0.051/+0.076 | 38.100 +/-0.127 | 41.28 | 4.76 | BF0254-0349-0381-BS4148HH |
| 25.400 (1.000") +0.051/+0.076 (mm) | 34.925 +0.076/+0.102 | 38.100 +/-0.127 | 41.28 | 4.76 | BF0254-0349-0381-BS4148HH2 |
| 25.400 (1.000") +0.025/+0.051 (mm) | 34.925 +0.051/+0.076 | 44.450 +/-0.190 | 41.28 | 4.76 | BF0254-0349-0445-BS4148TH |
| 25.400 (1.000") +0.051/+0.076 (mm) | 34.925 +0.051/+0.076 | 44.450 +/-0.127 | 41.28 | 4.76 | BF0254-0349-0445-BS4148HH |
| 25.400 (1.000") +0.051/+0.076 (mm) | 34.925 +0.076/+0.102 | 44.450 +/-0.127 | 41.28 | 4.76 | BF0254-0349-0445-BS4148HH2 |
| 25.400 (1.000") -0.025/+0.000 (mm) | 34.925 +0.063/+0.089 | 44.450 +/-0.190 | 44.45 | 4.76 | BF0254-0349-0445-BS4448UH |
| 25.400 (1.000") +0.051/+0.076 (mm) | 34.925 +0.051/+0.076 | 50.800 +/-0.127 | 41.28 | 4.76 | BF0254-0349-0508-BS4148HH |
| 25.400 (1.000") +0.051/+0.076 (mm) | 34.925 +0.076/+0.102 | 50.800 +/-0.127 | 41.28 | 4.76 | BF0254-0349-0508-BS4148HH2 |
| 25.400 (1.000") -0.025/+0.000 (mm) | 34.925 +0.063/+0.089 | 50.800 +/-0.190 | 44.45 | 4.76 | BF0254-0349-0508-BS4448UH |
| 28.000 (1.102") +0.005/+0.030 (mm) | 33.000 +0.040/+0.070 | 22.000 +/-0.120 | 38.00 | 2.50 | BF0280-0330-0220-BS3825LH |
| 28.000 (1.102") +0.005/+0.030 (mm) | 33.000 +0.040/+0.070 | 28.000 +/-0.120 | 38.00 | 2.50 | BF0280-0330-0280-BS3825LH |
| 28.000 (1.102") +0.005/+0.030 (mm) | 33.000 +0.040/+0.070 | 36.000 +/-0.120 | 38.00 | 2.50 | BF0280-0330-0360-BS3825LH |
| 28.000 (1.102") +0.005/+0.030 (mm) | 36.000 +0.040/+0.070 | 22.000 +/-0.120 | 44.00 | 4.00 | BF0280-0360-0220-BS4440LH |
| 28.000 (1.102") +0.005/+0.030 (mm) | 36.000 +0.040/+0.070 | 28.000 +/-0.120 | 44.00 | 4.00 | BF0280-0360-0280-BS4440LH |
| 28.000 (1.102") +0.005/+0.030 (mm) | 36.000 +0.040/+0.070 | 36.000 +/-0.120 | 44.00 | 4.00 | BF0280-0360-0360-BS4440LH |
| 28.575 (1.125") +0.025/+0.051 (mm) | 34.925 +0.025/+0.051 | 19.050 +/-0.190 | 44.45 | 3.18 | BF0286-0349-0191-BS4432TT |
| 28.575 (1.125") +0.025/+0.051 (mm) | 34.925 +0.025/+0.051 | 25.400 +/-0.127 | 44.45 | 3.18 | BF0286-0349-0254-BS4432TT |
| 28.575 (1.125") +0.025/+0.051 (mm) | 34.925 +0.025/+0.051 | 31.750 +/-0.127 | 44.45 | 3.18 | BF0286-0349-0318-BS4432TT |
| 30.000 (1.181") +0.005/+0.030 (mm) | 38.000 +0.040/+0.070 | 20.000 +/-0.127 | 46.00 | 4.00 | BF0300-0380-0200-BS4640TH |
| 30.000 (1.181") +0.005/+0.030 (mm) | 38.000 +0.040/+0.070 | 25.000 +/-0.127 | 46.00 | 4.00 | BF0300-0380-0250-BS4640TH |
| 30.000 (1.181") +0.005/+0.030 (mm) | 38.000 +0.040/+0.070 | 30.000 +/-0.127 | 46.00 | 4.00 | BF0300-0380-0300-BS4640TH |
| 31.750 (1.250") +0.012/+0.038 (mm) | 38.100 +0.051/+0.076 | 12.700 +/-0.127 | 42.86 | 3.18 | BF0318-0381-0127-BS4332LH |
| 31.750 (1.250") +0.025/+0.051 (mm) | 38.100 +0.051/+0.076 | 12.700 +/-0.127 | 42.86 | 3.18 | BF0318-0381-0127-BS4332TH |
| 31.750 (1.250") +0.025/+0.051 (mm) | 38.100 +0.051/+0.076 | 19.050 +/-0.127 | 42.86 | 3.18 | BF0318-0381-0191-BS4332TH |
| 31.750 (1.250") +0.025/+0.051 (mm) | 38.100 +0.051/+0.076 | 25.400 +/-0.127 | 42.86 | 3.18 | BF0318-0381-0254-BS4332TH |
| 31.750 (1.250") +0.025/+0.051 (mm) | 38.100 +0.051/+0.076 | 25.400 +/-0.190 | 44.45 | 4.76 | BF0318-0381-0254-BS4448TH |

 Stocked or Short Delivery

 Usually Available Short Delivery

 Long delivery or not in current production

* Large Minimum Quantities

** Available only while stock lasts

Bushes - Flanged

| Nominal ID (d) mm (inches) | Nominal OD (D) mm | Length (S) mm | Flange OD (D1) mm | Flange Thickness (S1) mm | Part Number |
|---------------------------------------|-------------------------|--------------------|----------------------|-----------------------------|----------------------------------|
| 31.750 (1.250") +0.064/+0.089 (mm) | 38.100 +0.076/+0.102 | 25.400 +/-0.127 | 44.45 | 4.76 | BF0318-0381-0254-BS4448HH |
| 31.750 (1.250") +0.012/+0.038 (mm) | 38.100 +0.051/+0.076 | 31.750 +/-0.127 | 42.86 | 3.18 | BF0318-0381-0318-BS4332LH |
| 31.750 (1.250") +0.025/+0.051 (mm) | 38.100 +0.051/+0.076 | 31.750 +/-0.127 | 42.86 | 3.18 | BF0318-0381-0318-BS4332TH |
| 31.750 (1.250") +0.025/+0.051 (mm) | 38.100 +0.051/+0.076 | 31.750 +/-0.127 | 44.45 | 4.76 | BF0318-0381-0318-BS4448TH |
| 31.750 (1.250") +0.064/+0.089 (mm) | 38.100 +0.076/+0.102 | 31.750 +/-0.127 | 44.45 | 4.76 | BF0318-0381-0318-BS4448HH |
| 31.750 (1.250") +0.025/+0.051 (mm) | 38.100 +0.051/+0.076 | 38.100 +/-0.127 | 42.86 | 3.18 | BF0318-0381-0381-BS4332TH |
| 31.750 (1.250") +0.025/+0.051 (mm) | 38.100 +0.051/+0.076 | 38.100 +/-0.127 | 44.45 | 4.76 | BF0318-0381-0381-BS4448TH |
| 31.750 (1.250") +0.064/+0.089 (mm) | 38.100 +0.076/+0.102 | 38.100 +/-0.127 | 44.45 | 4.76 | BF0318-0381-0381-BS4448HH |
| 31.750 (1.250") +0.025/+0.051 (mm) | 38.100 +0.051/+0.076 | 38.100 +/-0.127 | 50.80 | 2.38 | BF0318-0381-0381-BS5124TH |
| 31.750 (1.250") +0.025/+0.051 (mm) | 38.100 +0.051/+0.076 | 44.450 +/-0.127 | 42.86 | 3.18 | BF0318-0381-0445-BS4332TH |
| 31.750 (1.250") +0.064/+0.089 (mm) | 38.100 +0.076/+0.102 | 44.450 +/-0.127 | 44.45 | 4.76 | BF0318-0381-0445-BS4448HH |
| 31.750 (1.250") +0.025/+0.051 (mm) | 38.100 +0.051/+0.076 | 44.450 +/-0.190 | 50.80 | 2.38 | BF0318-0381-0445-BS5124TH |
| 32.000 (1.260") +0.009/+0.040 (mm) | 38.000 +0.040/+0.070 | 20.000 +/-0.120 | 44.00 | 3.00 | BF0320-0380-0200-BS4430LT |
| 32.000 (1.260") +0.009/+0.040 (mm) | 38.000 +0.040/+0.070 | 25.000 +/-0.127 | 44.00 | 3.00 | BF0320-0380-0250-BS4430LT |
| 32.000 (1.260") +0.009/+0.040 (mm) | 38.000 +0.040/+0.070 | 32.000 +/-0.127 | 44.00 | 3.00 | BF0320-0380-0320-BS4430LT |
| 32.000 (1.260") +0.009/+0.040 (mm) | 40.000 +0.040/+0.070 | 20.000 +/-0.120 | 48.00 | 4.00 | BF0320-0400-0200-BS4840LT |
| 32.000 (1.260") +0.009/+0.040 (mm) | 40.000 +0.040/+0.070 | 25.000 +/-0.120 | 48.00 | 4.00 | BF0320-0400-0250-BS4840LT |
| 32.000 (1.260") +0.009/+0.040 (mm) | 40.000 +0.040/+0.070 | 30.000 +/-0.120 | 48.00 | 4.00 | BF0320-0400-0300-BS4840LT |
| 32.000 (1.260") +0.009/+0.040 (mm) | 40.000 +0.040/+0.070 | 32.000 +/-0.120 | 48.00 | 4.00 | BF0320-0400-0320-BS4840LT |
| 34.925 (1.375") +0.025/+0.051 (mm) | 41.275 +0.051/+0.076 | 19.050 +/-0.190 | 50.80 | 3.18 | BF0349-0413-0191-BS5132TT |
| 34.925 (1.375") +0.025/+0.051 (mm) | 41.275 +0.051/+0.076 | 25.400 +/-0.127 | 50.80 | 3.18 | BF0349-0413-0254-BS5132TT |
| 35.000 (1.378") +0.025/+0.051 (mm) | 45.000 +0.043/+0.068 | 25.000 +/-0.127 | 55.00 | 5.00 | BF0350-0450-0250-BS5550TT |
| 35.000 (1.378") +0.025/+0.051 (mm) | 45.000 +0.043/+0.068 | 35.000 +/-0.127 | 55.00 | 5.00 | BF0350-0450-0350-BS5550TT |
| 35.000 (1.378") +0.009/+0.040 (mm) | 45.000 +0.040/+0.070 | 40.000 +/-0.190 | 55.00 | 5.00 | BF0350-0450-0400-BS5550LT |
| 36.000 (1.417") +0.009/+0.040 (mm) | 42.000 +0.040/+0.070 | 22.000 +/-0.120 | 48.00 | 3.00 | BF0360-0420-0220-BS4830LT |
| 36.000 (1.417") +0.009/+0.040 (mm) | 42.000 +0.040/+0.070 | 28.000 +/-0.120 | 48.00 | 3.00 | BF0360-0420-0280-BS4830LT |
| 36.000 (1.417") +0.009/+0.040 (mm) | 42.000 +0.040/+0.070 | 36.000 +/-0.120 | 48.00 | 3.00 | BF0360-0420-0360-BS4830LT |
| 36.000 (1.417") +0.009/+0.040 (mm) | 45.000 +0.040/+0.070 | 22.000 +/-0.120 | 54.00 | 4.50 | BF0360-0450-0220-BS5445LT |
| 36.000 (1.417") +0.009/+0.040 (mm) | 45.000 +0.040/+0.070 | 28.000 +/-0.120 | 54.00 | 4.50 | BF0360-0450-0280-BS5445LT |
| 36.000 (1.417") +0.009/+0.040 (mm) | 45.000 +0.040/+0.070 | 36.000 +/-0.120 | 54.00 | 4.50 | BF0360-0450-0360-BS5445LT |
| 38.100 (1.500") +0.051/+0.076 (mm) | 44.450 +0.025/+0.051 | 38.100 +/-0.127 | 50.80 | 2.38 | BF0381-0445-0381-BS5124HL |
| 38.100 (1.500") +0.076/+0.102 (mm) | 44.450 +0.089/+0.127 | 38.100 +/-0.127 | 50.80 | 4.76 | BF0381-0445-0381-BS5148HH |
| 38.100 (1.500") +0.051/+0.076 (mm) | 44.450 +0.064/+0.102 | 38.100 +/-0.127 | 52.400 | 4.76 | BF0381-0445-0381-BS5248HH |
| 40.000 (1.575") +0.009/+0.040 (mm) | 46.000 +0.040/+0.070 | 20.000 +/-0.127 | 56.00 | 5.00 | BF0400-0460-0200-BS5650LT |



Stocked or Short Delivery



Usually Available Short Delivery



Long delivery or not in current production

* Large Minimum Quantities

** Available only while stock lasts

Bushes - Flanged

| Nominal ID (d) mm (inches) | Nominal OD (D) mm | Length (S) mm | Flange OD (D1) mm | Flange Thickness (S1) mm | Part Number |
|---------------------------------------|-------------------------|--------------------|----------------------|-----------------------------|----------------------------------|
| 40.000 (1.575") +0.009/+0.040 (mm) | 46.000 +0.040/+0.070 | 25.000 +/-0.120 | 52.00 | 3.00 | BF0400-0460-0250-BS5230LT |
| 40.000 (1.575") +0.009/+0.040 (mm) | 46.000 +0.040/+0.070 | 32.000 +/-0.120 | 52.00 | 3.00 | BF0400-0460-0320-BS5230LT |
| 40.000 (1.575") +0.009/+0.040 (mm) | 46.000 +0.040/+0.070 | 40.000 +/-0.190 | 52.00 | 3.00 | BF0400-0460-0400-BS5230LT |
| 40.000 (1.575") +0.051/+0.076 (mm) | 50.000 +0.043/+0.082 | 25.000 +/-0.127 | 60.00 | 5.00 | BF0400-0500-0250-BS6050TH |
| 40.000 (1.575") +0.009/+0.040 (mm) | 50.000 +0.040/+0.070 | 30.000 +/-0.127 | 60.00 | 5.00 | BF0400-0500-0300-BS6050LT |
| 40.000 (1.575") +0.009/+0.040 (mm) | 50.000 +0.040/+0.070 | 32.000 +/-0.120 | 60.00 | 5.00 | BF0400-0500-0320-BS6050LT |
| 40.000 (1.575") +0.009/+0.040 (mm) | 50.000 +0.040/+0.070 | 40.000 +/-0.190 | 60.00 | 5.00 | BF0400-0500-0400-BS6050LT |
| 40.000 (1.575") +0.009/+0.040 (mm) | 50.000 +0.040/+0.070 | 50.000 +/-0.190 | 60.00 | 5.00 | BF0400-0500-0500-BS6050LT |
| 41.275 (1.625") +0.012/+0.038 (mm) | 50.800 +0.076/+0.102 | 50.800 +/-0.190 | 57.15 | 4.76 | BF0413-0508-0508-BS5748LH |
| 41.275 (1.625") +0.064/+0.102 (mm) | 50.800 +0.089/+0.127 | 50.800 +/-0.190 | 57.15 | 4.76 | BF0413-0508-0508-BS5748HH |
| 44.450 (1.750") +0.051/+0.076 (mm) | 57.150 +0.076/+0.102 | 63.500 +/-0.190 | 76.20 | 6.35 | BF0445-0572-0635-BS7664TH |
| 44.450 (1.750") +0.064/+0.102 (mm) | 57.150 +0.089/+0.127 | 63.500 +/-0.190 | 76.20 | 6.35 | BF0445-0572-0635-BS7664HH |
| 45.000 (1.772") +0.009/+0.040 (mm) | 51.000 +0.050/+0.083 | 28.000 +/-0.120 | 57.00 | 3.00 | BF0450-0510-0280-BS5730LT |
| 45.000 (1.772") +0.009/+0.040 (mm) | 51.000 +0.050/+0.083 | 36.000 +/-0.120 | 57.00 | 3.00 | BF0450-0510-0360-BS5730LT |
| 45.000 (1.772") +0.009/+0.040 (mm) | 51.000 +0.050/+0.083 | 45.000 +/-0.190 | 57.00 | 3.00 | BF0450-0510-0450-BS5730LT |
| 45.000 (1.772") +0.009/+0.040 (mm) | 56.000 +0.050/+0.083 | 28.000 +/-0.120 | 67.00 | 5.50 | BF0450-0560-0280-BS6755LT |
| 45.000 (1.772") +0.009/+0.040 (mm) | 56.000 +0.050/+0.083 | 36.000 +/-0.120 | 67.00 | 5.50 | BF0450-0560-0360-BS6755LT |
| 45.000 (1.772") +0.009/+0.040 (mm) | 56.000 +0.050/+0.083 | 45.000 +/-0.190 | 67.00 | 5.50 | BF0450-0560-0450-BS6755LT |
| 50.000 (1.969") +0.009/+0.040 (mm) | 56.000 +0.050/+0.083 | 30.000 +/-0.120 | 62.00 | 3.00 | BF0500-0560-0300-BS6230LT |
| 50.000 (1.969") +0.009/+0.040 (mm) | 56.000 +0.050/+0.083 | 32.000 +/-0.120 | 62.00 | 3.00 | BF0500-0560-0320-BS6230LT |
| 50.000 (1.969") +0.009/+0.040 (mm) | 56.000 +0.050/+0.083 | 40.000 +/-0.190 | 62.00 | 3.00 | BF0500-0560-0400-BS6230LT |
| 50.000 (1.969") +0.009/+0.040 (mm) | 56.000 +0.050/+0.083 | 50.000 +/-0.190 | 62.00 | 3.00 | BF0500-0560-0500-BS6230LT |
| 50.000 (1.969") +0.009/+0.040 (mm) | 60.000 +0.050/+0.083 | 32.000 +/-0.127 | 70.00 | 5.00 | BF0500-0600-0320-BS7050LT |
| 50.000 (1.969") +0.009/+0.040 (mm) | 60.000 +0.050/+0.083 | 35.000 +/-0.120 | 70.00 | 5.00 | BF0500-0600-0350-BS7050LT |
| 50.000 (1.969") +0.009/+0.040 (mm) | 60.000 +0.050/+0.083 | 40.000 +/-0.190 | 70.00 | 5.00 | BF0500-0600-0400-BS7050LT |
| 50.000 (1.969") +0.009/+0.040 (mm) | 60.000 +0.040/+0.070 | 50.000 +/-0.190 | 70.00 | 5.00 | BF0500-0600-0500-BS7050LT |
| 50.800 (2.000") +0.051/+0.076 (mm) | 57.150 +0.076/+0.102 | 19.050 +/-0.190 | 63.50 | 3.18 | BF0508-0572-0191-BS6432TH |
| 50.800 (2.000") +0.051/+0.076 (mm) | 57.150 +0.076/+0.102 | 25.400 +/-0.127 | 63.50 | 3.18 | BF0508-0572-0254-BS6432TH |
| 50.800 (2.000") +0.051/+0.076 (mm) | 57.150 +0.076/+0.102 | 31.750 +/-0.127 | 63.50 | 3.18 | BF0508-0572-0318-BS6432TH |
| 50.800 (2.000") +0.038/+0.076 (mm) | 57.150 +0.064/+0.102 | 50.800 +/-0.127 | 63.50 | 3.18 | BF0508-0572-0508-BS6432TH |
| 50.800 (2.000") +0.064/+0.102 (mm) | 57.150 +0.089/+0.127 | 50.800 +/-0.127 | 63.50 | 3.18 | BF0508-0572-0508-BS6432HH |
| 50.800 (2.000") +0.025/+0.051 (mm) | 63.500 +0.000/+0.025 | 60.325 +/-0.190 | 76.20 | 9.53 | BF0508-0635-0603-BS7695LL |
| 60.000 (2.362") +0.010/+0.040 (mm) | 70.000 +0.050/+0.083 | 50.000 +/-0.190 | 80.00 | 5.00 | BF0600-0700-0500-BS8050LT |
| 60.000 (2.362") +0.010/+0.040 (mm) | 70.000 +0.050/+0.083 | 60.000 +/-0.250 | 80.00 | 5.00 | BF0600-0700-0600-BS8050LT |



Stocked or Short Delivery



Usually Available Short Delivery



Long delivery or not in current production

* Large Minimum Quantities

** Available only while stock lasts

Bushes - Flanged

| Nominal ID (d) mm (inches) | Nominal OD (D) mm | Length (S) mm | Flange OD (D1) mm | Flange Thickness (S1) mm | Part Number |
|---------------------------------------|-------------------------|--------------------|----------------------|-----------------------------|----------------------------|
| 69.850 (2.750") +0.025/+0.051 (mm) | 82.550 -0.025/+0.000 | 38.100 +/-0.127 | 101.60 | 4.76 | BF0699-0826-0381-BS10248LU |
| 76.200 (3.000") +0.025/+0.051 (mm) | 88.900 +0.025/+0.051 | 60.325 +/-0.190 | 101.60 | 9.53 | BF0762-0889-0603-BS10295LL |

Bushes - Plain

| Nominal ID (d) mm (inches) | Nominal OD (D) mm | Length (S) mm | Part Number |
|--------------------------------------|-------------------------|--------------------|-----------------------|
| 1.191 (0.047") +0.000/+0.010 (mm) | 3.969 -0.010/+0.003 | 1.588 +0/-0.127 | BP0012-0040-0016-BSLU |
| 1.191 (0.047") +0.000/+0.010 (mm) | 3.969 -0.010/+0.003 | 2.380 +0/-0.127 | BP0012-0040-0024-BSLU |
| 1.191 (0.047") +0.000/+0.010 (mm) | 4.763 -0.010/+0.003 | 1.984 +0/-0.127 | BP0012-0048-0020-BSLU |
| 1.191 (0.047") +0.000/+0.010 (mm) | 4.763 -0.010/+0.003 | 2.779 +0/-0.127 | BP0012-0048-0028-BSLU |
| 1.588 (0.063") +0.000/+0.010 (mm) | 4.763 -0.010/+0.003 | 2.380 +0/-0.127 | BP0016-0048-0024-BSLU |
| 1.588 (0.063") +0.000/+0.010 (mm) | 6.350 -0.010/+0.003 | 2.380 +0/-0.127 | BP0016-0064-0024-BSLU |
| 1.984 (0.078") +0.000/+0.010 (mm) | 6.350 -0.010/+0.003 | 2.380 +0/-0.127 | BP0019-0064-0024-BSLU |
| 1.984 (0.078") +0.000/+0.010 (mm) | 6.350 -0.010/+0.003 | 3.571 +0/-0.127 | BP0019-0064-0036-BSLU |
| 2.000 (0.079") +0.014/+0.024 (mm) | 4.000 +0.015/+0.027 | 3.000 +0/-0.200 | BP0020-0040-0030-BSLL |
| 2.000 (0.079") +0.014/+0.024 (mm) | 4.000 +0.015/+0.027 | 4.000 +0/-0.200 | BP0020-0040-0040-BSLL |
| 2.000 (0.079") +0.000/+0.024 (mm) | 5.000 +0.019/+0.040 | 3.000 +0/-0.200 | BP0020-0050-0030-BSLL |
| 2.381 (0.094") +0.000/+0.010 (mm) | 4.763 -0.010/+0.003 | 1.588 +0/-0.127 | BP0024-0048-0016-BSLU |
| 2.381 (0.094") +0.000/+0.010 (mm) | 4.763 -0.010/+0.003 | 2.380 +0/-0.127 | BP0024-0048-0024-BSLU |
| 2.381 (0.094") +0.000/+0.010 (mm) | 6.350 -0.010/+0.003 | 1.588 +0/-0.127 | BP0024-0064-0016-BSLU |
| 2.381 (0.094") +0.000/+0.010 (mm) | 7.938 -0.010/+0.003 | 2.779 +0/-0.127 | BP0024-0079-0028-BSLU |
| 2.381 (0.094") +0.000/+0.010 (mm) | 7.938 -0.010/+0.003 | 3.571 +0/-0.127 | BP0024-0079-0036-BSLU |
| 3.000 (0.118") +0.014/+0.024 (mm) | 5.000 +0.015/+0.027 | 3.000 +0/-0.200 | BP0030-0050-0030-BSLL |
| 3.000 (0.118") +0.014/+0.024 (mm) | 5.000 +0.015/+0.027 | 4.000 +0/-0.200 | BP0030-0050-0040-BSLL |
| 3.000 (0.118") +0.000/+0.010 (mm) | 6.000 -0.008/+0.000 | 2.500 +0/-0.170 | BP0030-0060-0025-BSLU |
| 3.000 (0.118") +0.000/+0.024 (mm) | 6.000 +0.019/+0.040 | 4.000 +/-0.127 | BP0030-0060-0040-BSLL |
| 3.000 (0.118") +0.000/+0.020 (mm) | 6.000 +0.019/+0.040 | 5.000 +/-0.120 | BP0030-0060-0050-BSLL |
| 3.000 (0.118") +0.000/+0.020 (mm) | 6.000 +0.019/+0.040 | 6.000 +/-0.120 | BP0030-0060-0060-BSLL |
| 3.000 (0.118") +0.000/+0.020 (mm) | 6.000 +0.019/+0.040 | 10.000 +/-0.120 | BP0030-0060-0100-BSLL |
| 3.000 (0.118") +0.000/+0.010 (mm) | 8.000 -0.009/+0.000 | 3.000 +0/-0.170 | BP0030-0080-0030-BSLU |
| 3.000 (0.118") +0.000/+0.010 (mm) | 10.000 -0.009/+0.000 | 4.000 +0/-0.170 | BP0030-0100-0040-BSLU |
| 3.175 (0.125") +0.013/+0.038 (mm) | 4.763 +0.025/+0.051 | 3.175 | BP0032-0048-0032-BSLT |
| 3.175 (0.125") +0.038/+0.064 (mm) | 4.763 +0.051/+0.076 | 3.175 +/-0.127 | BP0032-0048-0032-BSTH |
| 3.175 (0.125") -0.025/+0.000 (mm) | 4.763 +0.038/+0.064 | 4.000 +/-0.127 | BP0032-0048-0040-BSUT |
| 3.175 (0.125") +0.013/+0.038 (mm) | 4.763 +0.025/+0.051 | 6.350 +/-0.127 | BP0032-0048-0064-BSLT |



Stocked or Short Delivery



Usually Available Short Delivery



Long delivery or not in current production

* Large Minimum Quantities

** Available only while stock lasts

Bushes - Plain

| Nominal ID (d) mm (inches) | Nominal OD (D) mm | Length (S) mm | Part Number |
|--------------------------------------|------------------------|---------------------|-------------------------------|
| 3.175 (0.125") +0.025/+0.051 (mm) | 4.763 +0.025/+0.051 | 6.350 +/-0.127 | BP0032-0048-0064-BSTT |
| 3.175 (0.125") +0.025/+0.051 (mm) | 4.763 +0.051/+0.076 | 6.350 +/-0.127 | BP0032-0048-0064-BSTH1 |
| 3.175 (0.125") +0.038/+0.064 (mm) | 4.763 +0.051/+0.076 | 6.350 +/-0.127 | BP0032-0048-0064-BSTH2 |
| 3.175 (0.125") -0.025/+0.000 (mm) | 4.763 +0.038/+0.064 | 6.350 +/-0.127 | BP0032-0048-0064-BSUT |
| 3.175 (0.125") +0.013/+0.038 (mm) | 4.763 +0.025/+0.051 | 7.938 +/-0.127 | BP0032-0048-0079-BSLT |
| 3.175 (0.125") -0.025/+0.000 (mm) | 4.763 +0.038/+0.064 | 9.525 +/-0.127 | BP0032-0048-0095-BSUT |
| 3.175 (0.125") +0.025/+0.051 (mm) | 4.763 +0.025/+0.051 | 12.700 +/-0.127 | BP0032-0048-0127-BSTT |
| 3.175 (0.125") +0.025/+0.051 (mm) | 4.763 +0.051/+0.076 | 12.700 +/-0.127 | 0 |
| 3.175 (0.125") -0.025/+0.000 (mm) | 4.763 +0.038/+0.064 | 12.700 +/-0.127 | BP0032-0048-0127-BSUT |
| 3.175 (0.125") +0.025/+0.051 (mm) | 5.556 +0.058/+0.084 | 6.350 +/-0.127 | BP0032-0056-0064-BSTH |
| 3.175 (0.125") +0.025/+0.051 (mm) | 5.556 +0.058/+0.084 | 9.525 +/-0.127 | BP0032-0056-0095-BSTH |
| 3.175 (0.125") +0.000/+0.010 (mm) | 6.350 -0.010/+0.003 | 2.380 +0/-0.127 | BP0032-0064-0024-BSLU |
| 3.175 (0.125") +0.000/+0.010 (mm) | 6.350 -0.010/+0.003 | 2.779 +0/-0.127 | BP0032-0064-0028-BSLU |
| 3.175 (0.125") +0.025/+0.051 (mm) | 6.350 +0.025/+0.051 | 3.175 +/-0.127 | BP0032-0064-0032-BSTT |
| 3.175 (0.125") +0.025/+0.051 (mm) | 6.350 +0.051/+0.076 | 3.175 +/-0.127 | BP0032-0064-0032-BSTH |
| 3.175 (0.125") +0.025/+0.051 (mm) | 6.350 +0.025/+0.051 | 6.350 +/-0.127 | BP0032-0064-0064-BSTT |
| 3.175 (0.125") +0.025/+0.051 (mm) | 6.350 +0.051/+0.076 | 6.350 +/-0.127 | BP0032-0064-0064-BSTH |
| 3.175 (0.125") +0.051/+0.076 (mm) | 6.350 +0.051/+0.076 | 6.350 +/-0.127 | BP0032-0064-0064-BSHH |
| 3.175 (0.125") +0.025/+0.051 (mm) | 6.350 +0.025/+0.051 | 9.525 +/-0.127 | BP0032-0064-0095-BSTT |
| 3.175 (0.125") +0.025/+0.051 (mm) | 6.350 +0.051/+0.076 | 9.525 +/-0.127 | BP0032-0064-0095-BSTH |
| 3.175 (0.125") +0.051/+0.076 (mm) | 6.350 +0.051/+0.076 | 9.525 +/-0.127 | BP0032-0064-0095-BSHH |
| 3.175 (0.125") +0.038/+0.064 (mm) | 6.350 +0.051/+0.076 | 10.516 +0/-0.102 | BP0032-0064-0105-BSTH |
| 3.175 (0.125") +0.025/+0.051 (mm) | 6.350 +0.025/+0.051 | 12.700 +/-0.127 | BP0032-0064-0127-BSTT |
| 3.175 (0.125") +0.025/+0.051 (mm) | 6.350 +0.051/+0.076 | 12.700 +/-0.127 | BP0032-0064-0127-BSTH |
| 3.175 (0.125") +0.000/+0.010 (mm) | 7.938 -0.010/+0.003 | 2.781 +0/-0.127 | BP0032-0079-0028-BSLU |
| 3.175 (0.125") +0.025/+0.051 (mm) | 7.938 +0.038/+0.064 | 3.175 +/-0.127 | BP0032-0079-0032-BSTT |
| 3.175 (0.125") +0.025/+0.051 (mm) | 7.938 +0.051/+0.076 | 3.175 +/-0.127 | BP0032-0079-0032-BSTH |
| 3.175 (0.125") +0.000/+0.010 (mm) | 7.938 -0.010/+0.003 | 3.571 +0/-0.127 | BP0032-0079-0036-BSLU |
| 3.175 (0.125") +0.025/+0.051 (mm) | 7.938 +0.025/+0.051 | 6.350 +/-0.127 | BP0032-0079-0064-BSTT1 |
| 3.175 (0.125") +0.025/+0.051 (mm) | 7.938 +0.038/+0.064 | 6.350 +/-0.127 | BP0032-0079-0064-BSTT2 |
| 3.175 (0.125") +0.025/+0.051 (mm) | 7.938 +0.051/+0.076 | 6.350 +/-0.127 | BP0032-0079-0064-BSTH |
| 3.175 (0.125") +0.025/+0.051 (mm) | 7.938 +0.025/+0.051 | 9.525 +/-0.127 | BP0032-0079-0095-BSTT1 |
| 3.175 (0.125") +0.025/+0.051 (mm) | 7.938 +0.038/+0.064 | 9.525 +/-0.127 | BP0032-0079-0095-BSTT2 |
| 3.175 (0.125") +0.025/+0.051 (mm) | 7.938 +0.051/+0.076 | 9.525 +/-0.127 | BP0032-0079-0095-BSTH |



Stocked or Short Delivery



Usually Available Short Delivery



Long delivery or not in current production

* Large Minimum Quantities

** Available only while stock lasts

Bushes - Plain

| Nominal ID (d) mm (inches) | Nominal OD (D) mm | Length (S) mm | Part Number |
|--------------------------------------|------------------------|--------------------|------------------------|
| 3.175 (0.125") +0.025/+0.051 (mm) | 7.938 +0.025/+0.051 | 12.700 +/-0.127 | BP0032-0079-0127-BSTT1 |
| 3.175 (0.125") +0.025/+0.051 (mm) | 7.938 +0.038/+0.064 | 12.700 +/-0.127 | BP0032-0079-0127-BSTT2 |
| 3.175 (0.125") +0.025/+0.051 (mm) | 7.938 +0.051/+0.076 | 12.700 +/-0.127 | BP0032-0079-0127-BSTH |
| 3.175 (0.125") +0.025/+0.051 (mm) | 7.938 +0.038/+0.064 | 15.875 +/-0.127 | BP0032-0079-0159-BSTT |
| 3.175 (0.125") +0.000/+0.010 (mm) | 9.525 -0.010/+0.003 | 2.779 +0/-0.127 | BP0032-0095-0028-BSLU |
| 3.175 (0.125") +0.000/+0.010 (mm) | 9.525 -0.010/+0.003 | 3.571 +0/-0.127 | BP0032-0095-0036-BSLU |
| 3.175 (0.125") +0.025/+0.051 (mm) | 9.525 +0.025/+0.051 | 6.350 +/-0.127 | BP0032-0095-0064-BSTT |
| 3.175 (0.125") +0.025/+0.051 (mm) | 9.525 +0.025/+0.051 | 12.700 +/-0.127 | BP0032-0095-0127-BSTT |
| 3.969 (0.156") -0.030/-0.005 (mm) | 5.556 +0.008/+0.033 | 6.350 +/-0.127 | BP0039-0056-0064-BSUL |
| 3.969 (0.156") -0.030/-0.005 (mm) | 5.556 +0.008/+0.033 | 9.525 +/-0.127 | BP0039-0056-0095-BSUL |
| 3.969 (0.156") +0.018/+0.043 (mm) | 6.350 +0.051/+0.076 | 3.175 +/-0.127 | BP0039-0064-0032-BSLH |
| 3.969 (0.156") +0.018/+0.043 (mm) | 6.350 +0.051/+0.076 | 4.750 +/-0.127 | BP0039-0064-0048-BSLH |
| 3.969 (0.156") +0.046/+0.071 (mm) | 6.350 +0.051/+0.076 | 6.350 +/-0.127 | BP0039-0064-0064-BSHH |
| 3.969 (0.156") +0.018/+0.043 (mm) | 6.350 +0.051/+0.076 | 6.731 +/-0.127 | BP0039-0064-0067-BSLH |
| 3.969 (0.156") +0.046/+0.071 (mm) | 6.350 +0.051/+0.076 | 7.938 +/-0.127 | BP0039-0064-0079-BSHH |
| 3.969 (0.156") -0.019/+0.006 (mm) | 6.350 +0.038/+0.064 | 9.525 +/-0.127 | BP0039-0064-0095-BSUT |
| 3.969 (0.156") +0.000/+0.010 (mm) | 7.938 -0.010/+0.003 | 2.779 +0/-0.127 | BP0039-0079-0028-BSLU |
| 3.969 (0.156") +0.000/+0.010 (mm) | 7.938 -0.010/+0.003 | 3.175 +0/-0.127 | BP0039-0079-0032-BSLU |
| 4.000 (0.157") +0.000/+0.020 (mm) | 6.000 +0.019/+0.040 | 8.000 +/-0.120 | BP0040-0060-0080-BSLL |
| 4.000 (0.157") +0.000/+0.020 (mm) | 6.000 +0.019/+0.040 | 10.000 +/-0.120 | BP0040-0060-0100-BSLL |
| 4.000 (0.157") +0.000/+0.020 (mm) | 6.000 +0.019/+0.040 | 17.000 +/-0.120 | BP0040-0060-0170-BSLL |
| 4.000 (0.157") +0.000/+0.020 (mm) | 7.000 +0.019/+0.040 | 4.000 +/-0.127 | BP0040-0070-0040-BSLL |
| 4.000 (0.157") +0.000/+0.020 (mm) | 7.000 +0.019/+0.040 | 8.000 +/-0.120 | BP0040-0070-0080-BSLL |
| 4.000 (0.157") +0.000/+0.020 (mm) | 7.000 +0.019/+0.040 | 10.000 +/-0.120 | BP0040-0070-0100-BSLL |
| 4.000 (0.157") +0.000/+0.020 (mm) | 7.000 +0.019/+0.040 | 12.000 +/-0.120 | BP0040-0070-0120-BSLL |
| 4.000 (0.157") +0.000/+0.012 (mm) | 8.000 -0.009/+0.000 | 4.000 +0/-0.200 | BP0040-0080-0040-BSLU |
| 4.000 (0.157") +0.000/+0.032 (mm) | 8.000 +0.019/+0.040 | 4.000 +0/-0.200 | BP0040-0080-0040-BSLL |
| 4.000 (0.157") +0.000/+0.032 (mm) | 8.000 +0.019/+0.040 | 6.000 +0/-0.200 | BP0040-0080-0060-BSLL |
| 4.000 (0.157") +0.000/+0.032 (mm) | 8.000 +0.019/+0.040 | 8.000 +0/-0.200 | BP0040-0080-0080-BSLL |
| 4.000 (0.157") +0.000/+0.020 (mm) | 8.000 +0.019/+0.040 | 10.000 +/-0.120 | BP0040-0080-0100-BSLL |
| 4.000 (0.157") +0.000/+0.020 (mm) | 8.000 +0.019/+0.040 | 12.000 +/-0.120 | BP0040-0080-0120-BSLL |
| 4.763 (0.188") +0.013/+0.038 (mm) | 6.350 +0.051/+0.076 | 4.750 +/-0.127 | BP0048-0064-0048-BSLH |
| 4.763 (0.188") +0.013/+0.038 (mm) | 6.350 +0.051/+0.076 | 5.334 +/-0.127 | BP0048-0064-0053-BSLH |



Stocked or Short Delivery



Usually Available Short Delivery



Long delivery or not in current production

* Large Minimum Quantities

** Available only while stock lasts

Bushes - Plain

| Nominal ID (d) mm (inches) | Nominal OD (D) mm | Length (S) mm | Part Number |
|--------------------------------------|------------------------|--------------------|------------------------------|
| 4.763 (0.188") +0.013/+0.038 (mm) | 6.350 +0.051/+0.076 | 6.172 +/-0.127 | BP0048-0064-0062-BSLH |
| 4.763 (0.188") +0.000/+0.025 (mm) | 6.350 +0.025/+0.051 | 6.350 +/-0.127 | BP0048-0064-0064-BSLT1 |
| 4.763 (0.188") +0.013/+0.038 (mm) | 6.350 +0.025/+0.051 | 6.350 +/-0.127 | BP0048-0064-0064-BSLT2 |
| 4.763 (0.188") +0.025/+0.051 (mm) | 6.350 +0.051/+0.076 | 6.350 +/-0.127 | BP0048-0064-0064-BSTH |
| 4.763 (0.188") -0.025/+0.000 (mm) | 6.350 +0.025/+0.051 | 6.350 +/-0.127 | BP0048-0064-0064-BSUT |
| 4.763 (0.188") +0.013/+0.038 (mm) | 6.350 +0.051/+0.076 | 7.747 +/-0.127 | BP0048-0064-0077-BSLH |
| 4.763 (0.188") -0.025/+0.000 (mm) | 6.350 +0.025/+0.051 | 7.938 +/-0.127 | BP0048-0064-0079-BSUT |
| 4.763 (0.188") +0.013/+0.038 (mm) | 6.350 +0.051/+0.076 | 8.382 +/-0.127 | BP0048-0064-0084-BSLH |
| 4.763 (0.188") +0.013/+0.038 (mm) | 6.350 +0.051/+0.076 | 8.712 +0/-0.152 | BP0048-0064-0087-BSLH |
| 4.763 (0.188") +0.000/+0.025 (mm) | 6.350 +0.025/+0.051 | 9.525 +/-0.127 | BP0048-0064-0095-BSLT1 |
| 4.763 (0.188") +0.013/+0.038 (mm) | 6.350 +0.025/+0.051 | 9.525 +/-0.127 | BP0048-0064-0095-BSLT2 |
| 4.763 (0.188") +0.025/+0.051 (mm) | 6.350 +0.051/+0.076 | 9.525 +/-0.127 | BP0048-0064-0095-BSTH |
| 4.763 (0.188") -0.025/+0.000 (mm) | 6.350 +0.025/+0.051 | 9.525 +/-0.127 | BP0048-0064-0095-BSUT |
| 4.763 (0.188") +0.013/+0.038 (mm) | 6.350 +0.051/+0.076 | 10.312 +/-0.127 | BP0048-0064-0103-BSLH |
| 4.763 (0.188") +0.000/+0.025 (mm) | 6.350 +0.025/+0.051 | 11.113 +/-0.127 | BP0048-0064-0111-BSLT |
| 4.763 (0.188") +0.013/+0.038 (mm) | 6.350 +0.051/+0.076 | 11.887 +/-0.127 | BP0048-0064-0119-BSLH |
| 4.763 (0.188") +0.000/+0.025 (mm) | 6.350 +0.025/+0.051 | 12.700 +/-0.127 | BP0048-0064-0127-BSLT1 |
| 4.763 (0.188") +0.013/+0.038 (mm) | 6.350 +0.025/+0.051 | 12.700 +/-0.127 | BP0048-0064-0127-BSLT2 |
| 4.763 (0.188") +0.025/+0.051 (mm) | 6.350 +0.051/+0.076 | 12.700 +/-0.127 | BP0048-0064-0127-BSTH |
| 4.763 (0.188") -0.025/+0.000 (mm) | 6.350 +0.025/+0.051 | 12.700 +/-0.127 | BP0048-0064-0127-BSUT |
| 4.763 (0.188") +0.000/+0.025 (mm) | 6.350 +0.025/+0.051 | 15.875 +/-0.127 | BP0048-0064-0159-BSLT1 |
| 4.763 (0.188") +0.013/+0.038 (mm) | 6.350 +0.025/+0.051 | 15.875 +/-0.127 | BP0048-0064-0159-BSLT2 |
| 4.763 (0.188") +0.025/+0.051 (mm) | 6.350 +0.051/+0.076 | 15.875 +/-0.127 | BP0048-0064-0159-BSTH |
| 4.763 (0.188") -0.025/+0.000 (mm) | 6.350 +0.025/+0.051 | 15.875 +/-0.127 | BP0048-0064-0159-BSUT |
| 4.763 (0.188") +0.013/+0.038 (mm) | 6.350 +0.025/+0.051 | 19.050 +/-0.127 | BP0048-0064-0191-BSLT |
| 4.763 (0.188") +0.025/+0.051 (mm) | 6.350 +0.051/+0.076 | 19.050 +/-0.127 | BP0048-0064-0191-BSTH |
| 4.763 (0.188") +0.013/+0.038 (mm) | 7.145 +0.046/+0.071 | 4.724 +0/-0.102 | BP0048-0071-0047-BSLH |
| 4.763 (0.188") +0.000/+0.025 (mm) | 7.938 +0.025/+0.051 | 4.763 +/-0.127 | BP0048-0079-0048-BSLT |
| 4.763 (0.188") +0.025/+0.051 (mm) | 7.938 +0.025/+0.051 | 4.763 +/-0.127 | BP0048-0079-0048-BSTT |
| 4.763 (0.188") +0.025/+0.051 (mm) | 7.938 +0.051/+0.076 | 4.763 +/-0.127 | BP0048-0079-0048-BSTH |
| 4.763 (0.188") +0.013/+0.038 (mm) | 7.938 +0.051/+0.076 | 6.325 +0/-0.102 | BP0048-0079-0063-BSLH |
| 4.763 (0.188") +0.000/+0.025 (mm) | 7.938 +0.025/+0.051 | 6.350 +/-0.127 | BP0048-0079-0064-BSLT |
| 4.763 (0.188") +0.013/+0.038 (mm) | 7.938 +0.013/+0.038 | 6.350 +/-0.127 | BP0048-0079-0064-BSLL |
| 4.763 (0.188") +0.025/+0.051 (mm) | 7.938 +0.025/+0.051 | 6.350 | BP0048-0079-0064-BSTT1 |



Stocked or Short Delivery



Usually Available Short Delivery



Long delivery or not in current production

* Large Minimum Quantities

** Available only while stock lasts

Bushes - Plain

| Nominal ID (d) mm (inches) | Nominal OD (D) mm | Length (S) mm | Part Number |
|--------------------------------------|------------------------|--------------------|-------------------------------|
| 4.763 (0.188") +0.025/+0.051 (mm) | 7.938 +0.051/+0.076 | 6.350 +/-0.127 | BP0048-0079-0064-BSTH |
| 4.763 (0.188") +0.038/+0.064 (mm) | 7.938 +0.025/+0.051 | 6.350 +/-0.127 | BP0048-0079-0064-BSTT2 |
| 4.763 (0.188") +0.000/+0.025 (mm) | 7.938 +0.025/+0.051 | 7.938 +/-0.127 | BP0048-0079-0079-BSLT |
| 4.763 (0.188") +0.025/+0.051 (mm) | 7.938 +0.051/+0.076 | 7.938 +/-0.127 | BP0048-0079-0079-BSTH |
| 4.763 (0.188") +0.000/+0.025 (mm) | 7.938 +0.025/+0.051 | 9.525 +/-0.127 | BP0048-0079-0095-BSLT |
| 4.763 (0.188") +0.013/+0.038 (mm) | 7.938 +0.013/+0.038 | 9.525 +/-0.127 | BP0048-0079-0095-BSLL |
| 4.763 (0.188") +0.025/+0.051 (mm) | 7.938 +0.025/+0.051 | 9.525 | BP0048-0079-0095-BSTT1 |
| 4.763 (0.188") +0.025/+0.051 (mm) | 7.938 +0.051/+0.076 | 9.525 +/-0.127 | BP0048-0079-0095-BSTH |
| 4.763 (0.188") +0.038/+0.064 (mm) | 7.938 +0.025/+0.051 | 9.525 +/-0.127 | BP0048-0079-0095-BSTT2 |
| 4.763 (0.188") +0.000/+0.025 (mm) | 7.938 +0.025/+0.051 | 11.113 +/-0.127 | BP0048-0079-0111-BSLT |
| 4.763 (0.188") +0.000/+0.025 (mm) | 7.938 +0.025/+0.051 | 12.700 +/-0.127 | BP0048-0079-0127-BSLT |
| 4.763 (0.188") +0.013/+0.038 (mm) | 7.938 +0.013/+0.038 | 12.700 +/-0.127 | BP0048-0079-0127-BSLL |
| 4.763 (0.188") +0.025/+0.051 (mm) | 7.938 +0.025/+0.051 | 12.700 | BP0048-0079-0127-BSTT1 |
| 4.763 (0.188") +0.025/+0.051 (mm) | 7.938 +0.051/+0.076 | 12.700 +/-0.127 | BP0048-0079-0127-BSTH |
| 4.763 (0.188") +0.038/+0.064 (mm) | 7.938 +0.025/+0.051 | 12.700 +/-0.127 | BP0048-0079-0127-BSTT2 |
| 4.763 (0.188") +0.000/+0.025 (mm) | 7.938 +0.025/+0.051 | 15.875 | BP0048-0079-0159-BSLT |
| 4.763 (0.188") +0.013/+0.038 (mm) | 7.938 +0.013/+0.038 | 15.875 +/-0.127 | BP0048-0079-0159-BSLL |
| 4.763 (0.188") +0.025/+0.051 (mm) | 7.938 +0.025/+0.051 | 15.875 +/-0.127 | BP0048-0079-0159-BSTT1 |
| 4.763 (0.188") +0.025/+0.051 (mm) | 7.938 +0.051/+0.076 | 15.875 +/-0.127 | BP0048-0079-0159-BSTH |
| 4.763 (0.188") +0.038/+0.064 (mm) | 7.938 +0.025/+0.051 | 15.875 +/-0.127 | BP0048-0079-0159-BSTT2 |
| 4.763 (0.188") +0.000/+0.025 (mm) | 7.938 +0.025/+0.051 | 19.050 +/-0.127 | BP0048-0079-0191-BSLT |
| 4.763 (0.188") +0.013/+0.038 (mm) | 7.938 +0.013/+0.038 | 19.050 +/-0.127 | BP0048-0079-0191-BSLL |
| 4.763 (0.188") +0.025/+0.051 (mm) | 7.938 +0.051/+0.076 | 19.050 +/-0.127 | BP0048-0079-0191-BSTH |
| 4.763 (0.188") +0.038/+0.064 (mm) | 7.938 +0.025/+0.051 | 19.050 +/-0.127 | BP0048-0079-0191-BSTT |
| 4.763 (0.188") +0.025/+0.051 (mm) | 7.938 +0.051/+0.076 | 25.400 +/-0.127 | BP0048-0079-0254-BSTH |
| 4.763 (0.188") +0.038/+0.064 (mm) | 7.938 +0.025/+0.051 | 25.400 +/-0.127 | BP0048-0079-0254-BSTT |
| 4.763 (0.188") +0.000/+0.010 (mm) | 9.525 -0.010/+0.003 | 3.175 +0/-0.127 | BP0048-0095-0032-BSLU |
| 4.763 (0.188") +0.000/+0.025 (mm) | 9.525 +0.038/+0.064 | 6.350 +/-0.127 | BP0048-0095-0064-BSLT |
| 4.763 (0.188") +0.025/+0.051 (mm) | 9.525 +0.051/+0.076 | 6.350 +/-0.127 | BP0048-0095-0064-BSTH |
| 4.763 (0.188") +0.000/+0.025 (mm) | 9.525 +0.038/+0.064 | 9.525 +/-0.127 | BP0048-0095-0095-BSLT |
| 4.763 (0.188") +0.025/+0.051 (mm) | 9.525 +0.051/+0.076 | 9.525 +/-0.127 | BP0048-0095-0095-BSTH |
| 4.763 (0.188") +0.038/+0.064 (mm) | 9.525 +0.025/+0.051 | 9.525 +/-0.127 | BP0048-0095-0095-BSTT |
| 4.763 (0.188") +0.000/+0.025 (mm) | 9.525 +0.038/+0.064 | 12.700 | BP0048-0095-0127-BSLT |
| 4.763 (0.188") +0.025/+0.051 (mm) | 9.525 +0.051/+0.076 | 12.700 +/-0.127 | BP0048-0095-0127-BSTH |



Stocked or Short Delivery



Usually Available Short Delivery



Long delivery or not in current production

* Large Minimum Quantities

** Available only while stock lasts

Bushes - Plain

| Nominal ID (d) mm (inches) | Nominal OD (D) mm | Length (S) mm | Part Number |
|--------------------------------------|-------------------------|--------------------|------------------------------|
| 4.763 (0.188") +0.038/+0.064 (mm) | 9.525 +0.025/+0.051 | 12.700 +/-0.127 | BP0048-0095-0127-BSTT |
| 4.763 (0.188") +0.025/+0.051 (mm) | 9.525 +0.051/+0.076 | 15.875 +/-0.127 | BP0048-0095-0159-BSTH |
| 4.763 (0.188") +0.038/+0.064 (mm) | 9.525 +0.025/+0.051 | 15.875 +/-0.127 | BP0048-0095-0159-BSTT |
| 4.763 (0.188") +0.025/+0.051 (mm) | 9.525 +0.051/+0.076 | 19.050 +/-0.127 | BP0048-0095-0191-BSTH |
| 4.763 (0.188") +0.038/+0.064 (mm) | 9.525 +0.025/+0.051 | 19.050 +/-0.127 | BP0048-0095-0191-BSTT |
| 4.763 (0.188") +0.013/+0.038 (mm) | 11.113 +0.051/+0.076 | 12.700 +/-0.127 | BP0048-0111-0127-BSLH |
| 4.763 (0.188") +0.000/+0.010 (mm) | 12.700 -0.010/+0.003 | 3.969 +0/-0.127 | BP0048-0127-0040-BSLU |
| 4.763 (0.188") +0.000/+0.010 (mm) | 12.700 -0.010/+0.003 | 4.978 +0/-0.127 | BP0048-0127-0050-BSLU |
| 5.000 (0.197") +0.000/+0.020 (mm) | 7.000 +0.019/+0.040 | 7.000 +/-0.120 | BP0050-0070-0070-BSLL |
| 5.000 (0.197") +0.000/+0.032 (mm) | 8.000 +0.019/+0.040 | 5.000 +0/-0.200 | BP0050-0080-0050-BSLL |
| 5.000 (0.197") +0.000/+0.032 (mm) | 8.000 +0.019/+0.040 | 8.000 +0/-0.200 | BP0050-0080-0080-BSLL |
| 5.000 (0.197") +0.000/+0.020 (mm) | 8.000 +0.019/+0.040 | 10.000 +/-0.127 | BP0050-0080-0100-BSLL |
| 5.000 (0.197") +0.000/+0.020 (mm) | 8.000 +0.019/+0.040 | 12.000 +/-0.127 | BP0050-0080-0120-BSLL |
| 5.000 (0.197") +0.000/+0.020 (mm) | 8.000 +0.019/+0.040 | 15.000 +/-0.120 | BP0050-0080-0150-BSLL |
| 5.000 (0.197") +0.000/+0.020 (mm) | 8.000 +0.019/+0.040 | 16.000 +/-0.127 | BP0050-0080-0160-BSLL |
| 5.000 (0.197") +0.000/+0.020 (mm) | 9.000 +0.019/+0.040 | 4.000 +/-0.120 | BP0050-0090-0040-BSLL |
| 5.000 (0.197") +0.000/+0.020 (mm) | 9.000 +0.019/+0.040 | 5.000 +/-0.127 | BP0050-0090-0050-BSLL |
| 5.000 (0.197") +0.000/+0.020 (mm) | 9.000 +0.019/+0.040 | 8.000 +/-0.127 | BP0050-0090-0080-BSLL |
| 5.000 (0.197") +0.000/+0.012 (mm) | 10.000 -0.009/+0.000 | 5.000 +0/-0.170 | BP0050-0100-0050-BSLU |
| 5.000 (0.197") +0.000/+0.012 (mm) | 12.000 -0.011/+0.000 | 4.000 +0/-0.170 | BP0050-0120-0040-BSLU |
| 5.000 (0.197") +0.000/+0.012 (mm) | 13.000 -0.011/+0.000 | 5.000 +0/-0.170 | BP0050-0130-0050-BSLU |
| 5.563 (0.219") -0.025/+0.000 (mm) | 7.938 +0.025/+0.051 | 7.938 +/-0.127 | BP0056-0079-0079-BSUT |
| 5.563 (0.219") -0.025/+0.000 (mm) | 7.938 +0.025/+0.051 | 9.525 +/-0.127 | BP0056-0079-0095-BSUT |
| 5.563 (0.219") -0.025/+0.000 (mm) | 11.113 +0.038/+0.064 | 12.700 +/-0.127 | BP0056-0111-0127-BSUT |
| 5.563 (0.219") -0.025/+0.000 (mm) | 11.113 +0.038/+0.064 | 19.050 +/-0.127 | BP0056-0111-0191-BSUT |
| 6.000 (0.236") +0.000/+0.020 (mm) | 9.000 +0.019/+0.040 | 4.000 +/-0.127 | BP0060-0090-0040-BSLL |
| 6.000 (0.236") +0.000/+0.020 (mm) | 9.000 +0.019/+0.040 | 6.000 +/-0.127 | BP0060-0090-0060-BSLL |
| 6.000 (0.236") +0.000/+0.020 (mm) | 9.000 +0.019/+0.040 | 8.000 +/-0.120 | BP0060-0090-0080-BSLL |
| 6.000 (0.236") +0.000/+0.020 (mm) | 9.000 +0.019/+0.040 | 10.000 +/-0.127 | BP0060-0090-0100-BSLL |
| 6.000 (0.236") +0.000/+0.025 (mm) | 9.000 +0.019/+0.040 | 12.000 +/-0.127 | BP0060-0090-0120-LL |
| 6.000 (0.236") +0.000/+0.020 (mm) | 9.000 +0.019/+0.040 | 15.000 +/-0.120 | BP0060-0090-0150-BSLL |
| 6.000 (0.236") +0.000/+0.020 (mm) | 9.000 +0.019/+0.040 | 16.000 +/-0.127 | BP0060-0090-0160-BSLL |
| 6.000 (0.236") +0.013/+0.038 (mm) | 9.525 +0.051/+0.076 | 6.350 +/-0.127 | BP0060-0095-0064-BSLH |
| 6.000 (0.236") +0.005/+0.030 (mm) | 10.000 +0.019/+0.040 | 4.000 +/-0.127 | BP0060-0100-0040-BSLL |



Stocked or Short Delivery



Usually Available Short Delivery



Long delivery or not in current production

* Large Minimum Quantities

** Available only while stock lasts

Bushes - Plain

| Nominal ID (d) mm (inches) | Nominal OD (D) mm | Length (S) mm | Part Number |
|--------------------------------------|-------------------------|---------------------|-----------------------|
| 6.000 (0.236") +0.000/+0.012 (mm) | 10.000 -0.009/+0.000 | 5.000 +0/-0.170 | BP0060-0100-0050-BSLU |
| 6.000 (0.236") +0.000/+0.032 (mm) | 10.000 +0.019/+0.040 | 6.000 +0/-0.200 | BP0060-0100-0060-BSLL |
| 6.000 (0.236") +0.000/+0.032 (mm) | 10.000 +0.019/+0.040 | 10.000 +0/-0.200 | BP0060-0100-0100-BSLL |
| 6.000 (0.236") +0.000/+0.020 (mm) | 10.000 +0.019/+0.040 | 12.000 +/-0.120 | BP0060-0100-0120-BSLL |
| 6.000 (0.236") +0.000/+0.020 (mm) | 10.000 +0.019/+0.040 | 14.000 +/-0.120 | BP0060-0100-0140-BSLL |
| 6.000 (0.236") +0.000/+0.020 (mm) | 10.000 +0.019/+0.040 | 16.000 +/-0.120 | BP0060-0100-0160-BSLL |
| 6.000 (0.236") +0.000/+0.020 (mm) | 12.000 +0.028/+0.050 | 6.000 +/-0.120 | BP0060-0120-0060-BSLT |
| 6.000 (0.236") +0.000/+0.032 (mm) | 12.000 +0.028/+0.050 | 8.000 +0/-0.200 | BP0060-0120-0080-BSLT |
| 6.000 (0.236") +0.000/+0.020 (mm) | 12.000 +0.028/+0.050 | 10.000 +/-0.120 | BP0060-0120-0100-BSLT |
| 6.000 (0.236") +0.000/+0.020 (mm) | 12.000 +0.028/+0.050 | 11.000 +/-0.120 | BP0060-0120-0110-BSLT |
| 6.000 (0.236") +0.020/+0.032 (mm) | 12.000 +0.028/+0.050 | 12.000 +0/-0.200 | BP0060-0120-0120-BSLT |
| 6.000 (0.236") +0.000/+0.020 (mm) | 12.000 +0.028/+0.050 | 15.000 +/-0.120 | BP0060-0120-0150-BSLT |
| 6.000 (0.236") +0.000/+0.020 (mm) | 12.000 +0.028/+0.050 | 16.000 +/-0.120 | BP0060-0120-0160-BSLT |
| 6.000 (0.236") +0.000/+0.020 (mm) | 12.000 +0.028/+0.050 | 25.000 +/-0.120 | BP0060-0120-0250-BSLT |
| 6.000 (0.236") +0.000/+0.012 (mm) | 16.000 -0.011/+0.000 | 5.000 +0/-0.170 | BP0060-0160-0050-BSLU |
| 6.350 (0.250") +0.025/+0.051 (mm) | 7.938 +0.051/+0.076 | 2.921 +/-0.127 | BP0064-0079-0029-BSTH |
| 6.350 (0.250") +0.025/+0.051 (mm) | 7.938 +0.051/+0.076 | 4.293 +0/-0.152 | BP0064-0079-0043-BSTH |
| 6.350 (0.250") +0.025/+0.051 (mm) | 7.938 +0.051/+0.076 | 4.750 +/-0.127 | BP0064-0079-0048-BSTH |
| 6.350 (0.250") +0.025/+0.051 (mm) | 7.938 +0.051/+0.076 | 5.944 +/-0.127 | BP0064-0079-0059-BSTH |
| 6.350 (0.250") +/-0.013 (mm) | 7.938 +0.025/+0.051 | 6.350 +/-0.127 | BP0064-0079-0064-BSUT |
| 6.350 (0.250") +0.013/+0.038 (mm) | 7.938 +0.051/+0.076 | 6.350 +/-0.127 | BP0064-0079-0064-BSLH |
| 6.350 (0.250") +0.025/+0.051 (mm) | 7.938 +0.038/+0.064 | 6.350 +/-0.127 | BP0064-0079-0064-BSTT |
| 6.350 (0.250") +0.025/+0.051 (mm) | 7.938 +0.051/+0.076 | 6.350 +/-0.127 | BP0064-0079-0064-BSTH |
| 6.350 (0.250") +0.025/+0.051 (mm) | 7.938 +0.051/+0.076 | 8.839 +/-0.127 | BP0064-0079-0088-BSTH |
| 6.350 (0.250") +0.013/+0.038 (mm) | 7.938 +0.051/+0.076 | 9.525 +/-0.127 | BP0064-0079-0095-BSLH |
| 6.350 (0.250") +0.025/+0.051 (mm) | 7.938 +0.038/+0.064 | 9.525 +/-0.127 | BP0064-0079-0095-BSTT |
| 6.350 (0.250") +0.025/+0.051 (mm) | 7.938 +0.051/+0.076 | 9.525 +/-0.127 | BP0064-0079-0095-BSTH |
| 6.350 (0.250") +0.025/+0.051 (mm) | 7.938 +0.051/+0.076 | 9.906 +/-0.127 | BP0064-0079-0099-BSTH |
| 6.350 (0.250") +0.025/+0.051 (mm) | 7.938 +0.051/+0.076 | 11.100 +/-0.127 | BP0064-0079-0111-BSTH |
| 6.350 (0.250") +/-0.013 (mm) | 7.938 +0.025/+0.051 | 11.113 +/-0.127 | BP0064-0079-0111-BSUT |
| 6.350 (0.250") +/-0.013 (mm) | 7.938 +0.025/+0.051 | 12.700 +/-0.127 | BP0064-0079-0127-BSUT |
| 6.350 (0.250") +0.025/+0.051 (mm) | 7.938 +0.038/+0.064 | 12.700 +/-0.127 | BP0064-0079-0127-BSTT |
| 6.350 (0.250") +0.025/+0.051 (mm) | 7.938 +0.051/+0.076 | 12.700 +/-0.127 | BP0064-0079-0127-BSTH |
| 6.350 (0.250") +0.051/+0.076 (mm) | 7.938 +0.051/+0.076 | 12.700 +/-0.127 | BP0064-0079-0127-BSHH |



Stocked or Short Delivery



Usually Available Short Delivery



Long delivery or not in current production

* Large Minimum Quantities

** Available only while stock lasts

Bushes - Plain

| Nominal ID (d) mm (inches) | Nominal OD (D) mm | Length (S) mm | Part Number |
|--------------------------------------|------------------------|---------------------|------------------------------|
| 6.350 (0.250") +0.025/+0.051 (mm) | 7.938 +0.051/+0.076 | 15.875 +/-0.127 | BP0064-0079-0159-BSTH |
| 6.350 (0.250") +0.051/+0.076 (mm) | 7.938 +0.051/+0.076 | 15.875 +/-0.127 | BP0064-0079-0159-BSHH |
| 6.350 (0.250") +0.025/+0.051 (mm) | 7.938 +0.038/+0.064 | 19.050 +/-0.127 | BP0064-0079-0191-BSTT |
| 6.350 (0.250") +0.025/+0.051 (mm) | 7.938 +0.051/+0.076 | 19.050 +/-0.127 | BP0064-0079-0191-BSTH |
| 6.350 (0.250") +0.051/+0.076 (mm) | 7.938 +0.051/+0.076 | 19.050 | BP0064-0079-0191-BSHH |
| 6.350 (0.250") +0.000/+0.010 (mm) | 9.525 -0.010/+0.003 | 3.175 +0/-0.127 | BP0064-0095-0032-BSLU |
| 6.350 (0.250") +0.025/+0.051 (mm) | 9.525 +0.051/+0.076 | 5.537 +/-0.127 | BP0064-0095-0055-BSTH |
| 6.350 (0.250") +/-0.013 (mm) | 9.525 +0.025/+0.051 | 6.350 +/-0.127 | BP0064-0095-0064-BSUT |
| 6.350 (0.250") +0.025/+0.051 (mm) | 9.525 +0.025/+0.051 | 6.350 | BP0064-0095-0064-BSTT |
| 6.350 (0.250") +0.025/+0.051 (mm) | 9.525 +0.051/+0.076 | 6.350 +/-0.127 | BP0064-0095-0064-BSTH |
| 6.350 (0.250") +0.051/+0.076 (mm) | 9.525 +0.025/+0.051 | 6.350 +/-0.127 | BP0064-0095-0064-BSHT |
| 6.350 (0.250") +0.025/+0.051 (mm) | 9.525 +0.051/+0.076 | 7.518 +/-0.127 | BP0064-0095-0075-BSTH |
| 6.350 (0.250") +/-0.013 (mm) | 9.525 +0.025/+0.051 | 7.938 +/-0.127 | BP0064-0095-0079-BSUT |
| 6.350 (0.250") +0.025/+0.051 (mm) | 9.525 +0.025/+0.051 | 7.938 | BP0064-0095-0079-BSTT |
| 6.350 (0.250") +0.025/+0.051 (mm) | 9.525 +0.051/+0.076 | 7.938 +/-0.127 | BP0064-0095-0079-BSTH |
| 6.350 (0.250") +/-0.013 (mm) | 9.525 +0.025/+0.051 | 9.525 +/-0.127 | BP0064-0095-0095-BSUT |
| 6.350 (0.250") +0.025/+0.051 (mm) | 9.525 +0.025/+0.051 | 9.525 | BP0064-0095-0095-BSTT |
| 6.350 (0.250") +0.025/+0.051 (mm) | 9.525 +0.051/+0.076 | 9.525 +/-0.127 | BP0064-0095-0095-BSTH |
| 6.350 (0.250") +0.025/+0.051 (mm) | 9.525 +0.051/+0.076 | 10.312 +/-0.127 | BP0064-0095-0103-BSTH |
| 6.350 (0.250") +0.025/+0.051 (mm) | 9.525 +0.051/+0.076 | 11.113 +/-0.127 | BP0064-0095-0111-BSTH |
| 6.350 (0.250") +/-0.013 (mm) | 9.525 +0.025/+0.051 | 12.700 +/-0.127 | BP0064-0095-0127-BSUT |
| 6.350 (0.250") +0.025/+0.051 (mm) | 9.525 +0.025/+0.051 | 12.700 +/-0.127 | BP0064-0095-0127-BSTT |
| 6.350 (0.250") +0.025/+0.051 (mm) | 9.525 +0.051/+0.076 | 12.700 +/-0.127 | BP0064-0095-0127-BSTH |
| 6.350 (0.250") +0.051/+0.076 (mm) | 9.525 +0.025/+0.051 | 12.700 +/-0.127 | BP0064-0095-0127-BSHT |
| 6.350 (0.250") +/-0.013 (mm) | 9.525 +0.025/+0.051 | 14.288 +/-0.127 | BP0064-0095-0143-BSUT |
| 6.350 (0.250") +0.025/+0.051 (mm) | 9.525 +0.051/+0.076 | 14.478 +0/-0.152 | BP0064-0095-0145-BSTH |
| 6.350 (0.250") +/-0.013 (mm) | 9.525 +0.025/+0.051 | 15.875 +/-0.127 | BP0064-0095-0159-BSUT |
| 6.350 (0.250") +0.025/+0.051 (mm) | 9.525 +0.025/+0.051 | 15.875 | BP0064-0095-0159-BSTT |
| 6.350 (0.250") +0.025/+0.051 (mm) | 9.525 +0.051/+0.076 | 15.875 +/-0.127 | BP0064-0095-0159-BSTH |
| 6.350 (0.250") +0.025/+0.051 (mm) | 9.525 +0.051/+0.076 | 18.263 +/-0.127 | BP0064-0095-0183-BSTH |
| 6.350 (0.250") +/-0.013 (mm) | 9.525 +0.025/+0.051 | 19.050 +/-0.127 | BP0064-0095-0191-BSUT |
| 6.350 (0.250") +0.025/+0.051 (mm) | 9.525 +0.025/+0.051 | 19.050 | BP0064-0095-0191-BSTT |
| 6.350 (0.250") +0.025/+0.051 (mm) | 9.525 +0.051/+0.076 | 19.050 +/-0.127 | BP0064-0095-0191-BSTH |
| 6.350 (0.250") +0.051/+0.076 (mm) | 9.525 +0.025/+0.051 | 19.050 +/-0.127 | BP0064-0095-0191-BSHT |

Stocked or Short Delivery

Usually Available Short Delivery

Long delivery or not in current production

* Large Minimum Quantities

** Available only while stock lasts

Bushes - Plain

| Nominal ID (d) mm (inches) | Nominal OD (D) mm | Length (S) mm | Part Number |
|--------------------------------------|-------------------------|--------------------|------------------------------|
| 6.350 (0.250") +/-0.013 (mm) | 9.525 +0.025/+0.051 | 22.225 | BP0064-0095-0222-BSUT |
| 6.350 (0.250") +0.025/+0.051 (mm) | 9.525 +0.025/+0.051 | 22.225 +/-0.127 | BP0064-0095-0222-BSTT |
| 6.350 (0.250") +0.025/+0.051 (mm) | 9.525 +0.051/+0.076 | 22.225 +/-0.127 | BP0064-0095-0222-BSTH |
| 6.350 (0.250") +/-0.013 (mm) | 9.525 +0.025/+0.051 | 25.400 | BP0064-0095-0254-BSUT |
| 6.350 (0.250") +0.025/+0.051 (mm) | 9.525 +0.025/+0.051 | 25.400 +/-0.127 | BP0064-0095-0254-BSTT |
| 6.350 (0.250") +0.025/+0.051 (mm) | 9.525 +0.051/+0.076 | 25.400 +/-0.127 | BP0064-0095-0254-BSTH |
| 6.350 (0.250") +/-0.013 (mm) | 9.525 +0.025/+0.051 | 28.575 | BP0064-0095-0286-BSUT |
| 6.350 (0.250") +0.025/+0.051 (mm) | 9.525 +0.025/+0.051 | 28.575 +/-0.127 | BP0064-0095-0286-BSTT |
| 6.350 (0.250") +0.025/+0.051 (mm) | 9.525 +0.051/+0.076 | 28.575 +/-0.127 | BP0064-0095-0286-BSTH |
| 6.350 (0.250") +/-0.013 (mm) | 9.525 +0.025/+0.051 | 31.750 | BP0064-0095-0318-BSUT |
| 6.350 (0.250") +0.025/+0.051 (mm) | 9.525 +0.025/+0.051 | 31.750 +/-0.127 | BP0064-0095-0318-BSTT |
| 6.350 (0.250") +0.025/+0.051 (mm) | 9.525 +0.051/+0.076 | 31.750 +/-0.127 | BP0064-0095-0318-BSTH |
| 6.350 (0.250") +0.000/+0.025 (mm) | 11.113 +0.025/+0.051 | 9.525 +/-0.127 | BP0064-0111-0095-BSLT |
| 6.350 (0.250") +0.025/+0.051 (mm) | 11.113 +0.013/+0.038 | 9.525 +/-0.127 | BP0064-0111-0095-BSTL |
| 6.350 (0.250") +0.025/+0.051 (mm) | 11.113 +0.025/+0.051 | 9.525 +/-0.127 | BP0064-0111-0095-BSTT |
| 6.350 (0.250") +0.025/+0.051 (mm) | 11.113 +0.051/+0.076 | 9.525 +/-0.127 | BP0064-0111-0095-BSTH |
| 6.350 (0.250") +0.025/+0.051 (mm) | 11.113 +0.051/+0.076 | 10.338 +/-0.127 | BP0064-0111-0103-BSTH |
| 6.350 (0.250") +0.025/+0.051 (mm) | 11.113 +0.051/+0.076 | 11.100 +/-0.127 | BP0064-0111-0111-BSTH |
| 6.350 (0.250") +0.000/+0.025 (mm) | 11.113 +0.025/+0.051 | 12.700 +/-0.127 | BP0064-0111-0127-BSLT |
| 6.350 (0.250") +0.025/+0.051 (mm) | 11.113 +0.013/+0.038 | 12.700 +/-0.127 | BP0064-0111-0127-BSTL |
| 6.350 (0.250") +0.025/+0.051 (mm) | 11.113 +0.025/+0.051 | 12.700 +/-0.127 | BP0064-0111-0127-BSTT |
| 6.350 (0.250") +0.025/+0.051 (mm) | 11.113 +0.051/+0.076 | 12.700 +/-0.127 | BP0064-0111-0127-BSTH |
| 6.350 (0.250") +0.000/+0.025 (mm) | 11.113 +0.025/+0.051 | 15.875 +/-0.127 | BP0064-0111-0159-BSLT |
| 6.350 (0.250") +0.025/+0.051 (mm) | 11.113 +0.013/+0.038 | 15.875 +/-0.127 | BP0064-0111-0159-BSTL |
| 6.350 (0.250") +0.025/+0.051 (mm) | 11.113 +0.025/+0.051 | 15.875 +/-0.127 | BP0064-0111-0159-BSTT |
| 6.350 (0.250") +0.025/+0.051 (mm) | 11.113 +0.051/+0.076 | 15.875 +/-0.127 | BP0064-0111-0159-BSTH |
| 6.350 (0.250") +0.000/+0.025 (mm) | 11.113 +0.025/+0.051 | 19.050 +/-0.127 | BP0064-0111-0191-BSLT |
| 6.350 (0.250") +0.025/+0.051 (mm) | 11.113 +0.013/+0.038 | 19.050 +/-0.127 | BP0064-0111-0191-BSTL |
| 6.350 (0.250") +0.025/+0.051 (mm) | 11.113 +0.025/+0.051 | 19.050 +/-0.127 | BP0064-0111-0191-BSTT |
| 6.350 (0.250") +0.025/+0.051 (mm) | 11.113 +0.051/+0.076 | 19.050 +/-0.127 | BP0064-0111-0191-BSTH |
| 6.350 (0.250") +0.000/+0.025 (mm) | 11.113 +0.025/+0.051 | 22.225 +/-0.127 | BP0064-0111-0222-BSLT |
| 6.350 (0.250") +0.025/+0.051 (mm) | 11.113 +0.013/+0.038 | 22.225 +/-0.127 | BP0064-0111-0222-BSTL |
| 6.350 (0.250") +0.025/+0.051 (mm) | 11.113 +0.051/+0.076 | 22.225 +/-0.127 | BP0064-0111-0222-BSTH |
| 6.350 (0.250") +0.000/+0.025 (mm) | 11.113 +0.025/+0.051 | 25.400 +/-0.127 | BP0064-0111-0254-BSLT |

Stocked or Short Delivery
 Usually Available Short Delivery
 Long delivery or not in current production

* Large Minimum Quantities

** Available only while stock lasts

Bushes - Plain

| Nominal ID (d) mm (inches) | Nominal OD (D) mm | Length (S) mm | Part Number |
|--------------------------------------|-------------------------|---------------------|------------------------------|
| 6.350 (0.250") +0.025/+0.051 (mm) | 11.113 +0.013/+0.038 | 25.400 +/-0.127 | BP0064-0111-0254-BSTL |
| 6.350 (0.250") +0.025/+0.051 (mm) | 11.113 +0.025/+0.051 | 25.400 +/-0.127 | BP0064-0111-0254-BSTT |
| 6.350 (0.250") +0.025/+0.051 (mm) | 11.113 +0.051/+0.076 | 25.400 +/-0.127 | BP0064-0111-0254-BSTH |
| 6.350 (0.250") +0.000/+0.010 (mm) | 12.700 -0.010/+0.003 | 3.175 +0/-0.127 | BP0064-0127-0032-BSLU |
| 6.350 (0.250") +0.000/+0.010 (mm) | 12.700 -0.010/+0.003 | 4.763 +0/-0.127 | BP0064-0127-0048-BSLU |
| 6.350 (0.250") +0.000/+0.025 (mm) | 12.700 +0.051/+0.076 | 5.537 +/-0.127 | BP0064-0127-0055-BSLH |
| 6.350 (0.250") +0.025/+0.051 (mm) | 12.700 +0.013/+0.038 | 7.938 +/-0.127 | BP0064-0127-0079-BSTL |
| 6.350 (0.250") +0.025/+0.051 (mm) | 12.700 +0.051/+0.076 | 7.938 +/-0.127 | BP0064-0127-0079-BSTH |
| 6.350 (0.250") +0.025/+0.051 (mm) | 12.700 +0.025/+0.051 | 9.525 +/-0.127 | BP0064-0127-0095-BSTT |
| 6.350 (0.250") +0.025/+0.051 (mm) | 12.700 +0.013/+0.038 | 12.700 +/-0.127 | BP0064-0127-0127-BSTL |
| 6.350 (0.250") +0.025/+0.051 (mm) | 12.700 +0.025/+0.051 | 12.700 +/-0.127 | BP0064-0127-0127-BSTT |
| 6.350 (0.250") +0.025/+0.051 (mm) | 12.700 +0.051/+0.076 | 12.700 +/-0.127 | BP0064-0127-0127-BSTH |
| 6.350 (0.250") +0.025/+0.051 (mm) | 12.700 +0.025/+0.051 | 15.875 +/-0.127 | BP0064-0127-0159-BSTT |
| 6.350 (0.250") +0.025/+0.051 (mm) | 12.700 +0.013/+0.038 | 19.050 +/-0.127 | BP0064-0127-0191-BSTL |
| 6.350 (0.250") +0.025/+0.051 (mm) | 12.700 +0.025/+0.051 | 19.050 +/-0.127 | BP0064-0127-0191-BSTT |
| 6.350 (0.250") +0.025/+0.051 (mm) | 12.700 +0.051/+0.076 | 19.050 +/-0.127 | BP0064-0127-0191-BSTH |
| 6.350 (0.250") +0.025/+0.051 (mm) | 12.700 +0.025/+0.051 | 22.225 +/-0.127 | BP0064-0127-0222-BSTT |
| 6.350 (0.250") +0.025/+0.051 (mm) | 12.700 +0.013/+0.038 | 25.400 +/-0.127 | BP0064-0127-0254-BSTL |
| 6.350 (0.250") +0.025/+0.051 (mm) | 12.700 +0.025/+0.051 | 25.400 +/-0.127 | BP0064-0127-0254-BSTT |
| 6.350 (0.250") +0.025/+0.051 (mm) | 12.700 +0.051/+0.076 | 25.400 +/-0.127 | BP0064-0127-0254-BSTH |
| 6.350 (0.250") +0.025/+0.051 (mm) | 12.700 +0.025/+0.051 | 31.750 +/-0.127 | BP0064-0127-0318-BSTT |
| 6.350 (0.250") +0.025/+0.051 (mm) | 12.700 +0.051/+0.076 | 31.750 +/-0.127 | BP0064-0127-0318-BSTH |
| 6.350 (0.250") +0.000/+0.010 (mm) | 15.875 -0.010/+0.003 | 4.978 +0/-0.127 | BP0064-0159-0050-BSLU |
| 7.000 (0.276") +0.005/+0.030 (mm) | 10.000 +0.019/+0.040 | 5.000 +/-0.120 | BP0070-0100-0050-BSLL |
| 7.000 (0.276") +0.005/+0.030 (mm) | 10.000 +0.015/+0.041 | 8.000 +/-0.127 | BP0070-0100-0080-BSLL |
| 7.000 (0.276") +0.005/+0.040 (mm) | 10.000 +0.019/+0.040 | 10.000 +0/-0.200 | BP0070-0100-0100-BSLL |
| 7.000 (0.276") +0.005/+0.030 (mm) | 11.000 +0.025/+0.051 | 8.000 +/-0.127 | BP0070-0110-0080-BSLT |
| 7.938 (0.313") +0.013/+0.038 (mm) | 9.525 +0.051/+0.076 | 3.175 +/-0.127 | BP0079-0095-0032-BSLH |
| 7.938 (0.313") +0.013/+0.038 (mm) | 9.525 +0.051/+0.076 | 5.283 +/-0.127 | BP0079-0095-0053-BSLH |
| 7.938 (0.313") +0.000/+0.025 (mm) | 9.525 +0.025/+0.051 | 6.350 +/-0.127 | BP0079-0095-0064-BSLT |
| 7.938 (0.313") +0.025/+0.051 (mm) | 9.525 +0.051/+0.076 | 6.350 +/-0.127 | BP0079-0095-0064-BSTH |
| 7.938 (0.313") +0.013/+0.038 (mm) | 9.525 +0.051/+0.076 | 7.137 +/-0.127 | BP0079-0095-0071-BSLH |
| 7.938 (0.313") +0.000/+0.025 (mm) | 9.525 +0.025/+0.051 | 7.938 +/-0.127 | BP0079-0095-0079-BSLT |
| 7.938 (0.313") +0.013/+0.038 (mm) | 9.525 +0.051/+0.076 | 9.398 +/-0.127 | BP0079-0095-0094-BSLH |

Stocked or Short Delivery

Usually Available Short Delivery

Long delivery or not in current production

* Large Minimum Quantities

** Available only while stock lasts

Bushes - Plain

| Nominal ID (d) mm (inches) | Nominal OD (D) mm | Length (S) mm | Part Number |
|--------------------------------------|-------------------------|--------------------|------------------------------|
| 7.938 (0.313") +0.000/+0.025 (mm) | 9.525 +0.025/+0.051 | 9.525 | BP0079-0095-0095-BSLT1 |
| 7.938 (0.313") +0.013/+0.038 (mm) | 9.525 +0.025/+0.051 | 9.525 +/-0.127 | BP0079-0095-0095-BSLT2 |
| 7.938 (0.313") +0.025/+0.051 (mm) | 9.525 +0.051/+0.076 | 9.525 +/-0.127 | BP0079-0095-0095-BSTH |
| 7.938 (0.313") +0.013/+0.038 (mm) | 9.525 +0.051/+0.076 | 10.693 +/-0.127 | BP0079-0095-0107-BSLH |
| 7.938 (0.313") +0.013/+0.038 (mm) | 9.525 +0.051/+0.076 | 12.370 +/-0.127 | BP0079-0095-0124-BSLH |
| 7.938 (0.313") +0.000/+0.025 (mm) | 9.525 +0.025/+0.051 | 12.700 | BP0079-0095-0127-BSLT1 |
| 7.938 (0.313") +0.013/+0.038 (mm) | 9.525 +0.025/+0.051 | 12.700 +/-0.127 | BP0079-0095-0127-BSLT2 |
| 7.938 (0.313") +0.025/+0.051 (mm) | 9.525 +0.051/+0.076 | 12.700 +/-0.127 | BP0079-0095-0127-BSTH |
| 7.938 (0.313") +0.000/+0.025 (mm) | 9.525 +0.025/+0.051 | 15.875 | BP0079-0095-0159-BSLT1 |
| 7.938 (0.313") +0.013/+0.038 (mm) | 9.525 +0.025/+0.051 | 15.875 +/-0.127 | BP0079-0095-0159-BSLT2 |
| 7.938 (0.313") +0.025/+0.051 (mm) | 9.525 +0.051/+0.076 | 15.875 +/-0.127 | BP0079-0095-0159-BSTH |
| 7.938 (0.313") +0.000/+0.025 (mm) | 9.525 +0.025/+0.051 | 19.050 | BP0079-0095-0191-BSLT1 |
| 7.938 (0.313") +0.013/+0.038 (mm) | 9.525 +0.025/+0.051 | 19.050 +/-0.127 | BP0079-0095-0191-BSLT2 |
| 7.938 (0.313") +0.025/+0.051 (mm) | 9.525 +0.051/+0.076 | 19.050 +/-0.127 | BP0079-0095-0191-BSTH |
| 7.938 (0.313") +0.013/+0.038 (mm) | 9.525 +0.025/+0.051 | 22.225 +/-0.127 | BP0079-0095-0222-BSLT |
| 7.938 (0.313") +0.025/+0.051 (mm) | 9.525 +0.051/+0.076 | 22.225 +/-0.127 | BP0079-0095-0222-BSTH |
| 7.938 (0.313") +0.013/+0.038 (mm) | 9.525 +0.025/+0.051 | 25.400 +/-0.127 | BP0079-0095-0254-BSLT |
| 7.938 (0.313") +0.025/+0.051 (mm) | 9.525 +0.051/+0.076 | 25.400 +/-0.127 | BP0079-0095-0254-BSTH |
| 7.938 (0.313") +0.013/+0.038 (mm) | 11.113 +0.051/+0.076 | 4.750 +/-0.127 | BP0079-0111-0048-BSLH |
| 7.938 (0.313") +0.000/+0.025 (mm) | 11.113 +0.025/+0.051 | 6.350 +/-0.127 | BP0079-0111-0064-BSLT |
| 7.938 (0.313") +0.013/+0.038 (mm) | 11.113 +0.013/+0.038 | 6.350 +/-0.127 | BP0079-0111-0064-BSLL |
| 7.938 (0.313") +0.025/+0.051 (mm) | 11.113 +0.038/+0.064 | 6.350 +/-0.127 | BP0079-0111-0064-BSTT |
| 7.938 (0.313") +0.025/+0.051 (mm) | 11.113 +0.051/+0.076 | 6.350 +/-0.127 | BP0079-0111-0064-BSTH |
| 7.938 (0.313") +0.051/+0.076 (mm) | 11.113 +0.025/+0.051 | 6.350 +/-0.127 | BP0079-0111-0064-BSHT |
| 7.938 (0.313") -0.025/+0.000 (mm) | 11.113 +0.038/+0.064 | 6.350 +/-0.127 | BP0079-0111-0064-BSUT |
| 7.938 (0.313") +0.000/+0.025 (mm) | 11.113 +0.025/+0.051 | 7.938 +/-0.127 | BP0079-0111-0079-BSLT |
| 7.938 (0.313") +0.025/+0.051 (mm) | 11.113 +0.051/+0.076 | 7.938 +/-0.127 | BP0079-0111-0079-BSTH |
| 7.938 (0.313") -0.025/+0.000 (mm) | 11.113 +0.038/+0.064 | 7.938 +/-0.127 | BP0079-0111-0079-BSUT |
| 7.938 (0.313") +0.000/+0.025 (mm) | 11.113 +0.025/+0.051 | 9.525 +/-0.127 | BP0079-0111-0095-BSLT |
| 7.938 (0.313") +0.013/+0.038 (mm) | 11.113 +0.013/+0.038 | 9.525 +/-0.127 | BP0079-0111-0095-BSLL |
| 7.938 (0.313") +0.025/+0.051 (mm) | 11.113 +0.038/+0.064 | 9.525 +/-0.127 | BP0079-0111-0095-BSTT |
| 7.938 (0.313") +0.025/+0.051 (mm) | 11.113 +0.051/+0.076 | 9.525 +/-0.127 | BP0079-0111-0095-BSTH |
| 7.938 (0.313") -0.025/+0.000 (mm) | 11.113 +0.038/+0.064 | 9.525 +/-0.127 | BP0079-0111-0095-BSUT |
| 7.938 (0.313") -0.051/-0.025 (mm) | 11.113 +0.064/+0.089 | 9.525 +/-0.127 | BP0079-0111-0095-BSUH |



Stocked or Short Delivery



Usually Available Short Delivery



Long delivery or not in current production

* Large Minimum Quantities

** Available only while stock lasts

Bushes - Plain

| Nominal ID (d) mm (inches) | Nominal OD (D) mm | Length (S) mm | Part Number |
|--------------------------------------|-------------------------|--------------------|------------------------------|
| 7.938 (0.313") +0.000/+0.025 (mm) | 11.113 +0.025/+0.051 | 11.113 +/-0.127 | BP0079-0111-0111-BSLT |
| 7.938 (0.313") +0.000/+0.025 (mm) | 11.113 +0.025/+0.051 | 12.700 +/-0.127 | BP0079-0111-0127-BSLT |
| 7.938 (0.313") +0.013/+0.038 (mm) | 11.113 +0.013/+0.038 | 12.700 +/-0.127 | BP0079-0111-0127-BSLL |
| 7.938 (0.313") +0.025/+0.051 (mm) | 11.113 +0.038/+0.064 | 12.700 +/-0.127 | BP0079-0111-0127-BSTT |
| 7.938 (0.313") +0.025/+0.051 (mm) | 11.113 +0.051/+0.076 | 12.700 +/-0.127 | BP0079-0111-0127-BSTH |
| 7.938 (0.313") +0.051/+0.076 (mm) | 11.113 +0.025/+0.051 | 12.700 +/-0.127 | BP0079-0111-0127-BSHT |
| 7.938 (0.313") -0.025/+0.000 (mm) | 11.113 +0.038/+0.064 | 12.700 +/-0.127 | BP0079-0111-0127-BSUT |
| 7.938 (0.313") -0.051/-0.025 (mm) | 11.113 +0.064/+0.089 | 12.700 +/-0.127 | BP0079-0111-0127-BSUH |
| 7.938 (0.313") +0.000/+0.025 (mm) | 11.113 +0.025/+0.051 | 15.875 +/-0.127 | BP0079-0111-0159-BSLT |
| 7.938 (0.313") +0.013/+0.038 (mm) | 11.113 +0.013/+0.038 | 15.875 +/-0.127 | BP0079-0111-0159-BSLL |
| 7.938 (0.313") +0.025/+0.051 (mm) | 11.113 +0.038/+0.064 | 15.875 +/-0.127 | BP0079-0111-0159-BSTT |
| 7.938 (0.313") +0.025/+0.051 (mm) | 11.113 +0.051/+0.076 | 15.875 +/-0.127 | BP0079-0111-0159-BSTH |
| 7.938 (0.313") -0.025/+0.000 (mm) | 11.113 +0.038/+0.064 | 15.875 +/-0.127 | BP0079-0111-0159-BSUT |
| 7.938 (0.313") +0.000/+0.025 (mm) | 11.113 +0.025/+0.051 | 17.463 +/-0.127 | BP0079-0111-0175-BSLT |
| 7.938 (0.313") +0.000/+0.025 (mm) | 11.113 +0.025/+0.051 | 19.050 +/-0.127 | BP0079-0111-0191-BSLT |
| 7.938 (0.313") +0.013/+0.038 (mm) | 11.113 +0.013/+0.038 | 19.050 +/-0.127 | BP0079-0111-0191-BSLL |
| 7.938 (0.313") +0.025/+0.051 (mm) | 11.113 +0.038/+0.064 | 19.050 +/-0.127 | BP0079-0111-0191-BSTT |
| 7.938 (0.313") +0.025/+0.051 (mm) | 11.113 +0.051/+0.076 | 19.050 +/-0.127 | BP0079-0111-0191-BSTH |
| 7.938 (0.313") +0.051/+0.076 (mm) | 11.113 +0.025/+0.051 | 19.050 +/-0.127 | BP0079-0111-0191-BSHT |
| 7.938 (0.313") -0.025/+0.000 (mm) | 11.113 +0.038/+0.064 | 19.050 +/-0.127 | BP0079-0111-0191-BSUT |
| 7.938 (0.313") +0.000/+0.025 (mm) | 11.113 +0.025/+0.051 | 22.225 +/-0.127 | BP0079-0111-0222-BSLT |
| 7.938 (0.313") +0.013/+0.038 (mm) | 11.113 +0.013/+0.038 | 22.225 +/-0.127 | BP0079-0111-0222-BSLL |
| 7.938 (0.313") +0.025/+0.051 (mm) | 11.113 +0.038/+0.064 | 22.225 +/-0.127 | BP0079-0111-0222-BSTT |
| 7.938 (0.313") +0.025/+0.051 (mm) | 11.113 +0.051/+0.076 | 22.225 +/-0.127 | BP0079-0111-0222-BSTH |
| 7.938 (0.313") +0.000/+0.025 (mm) | 11.113 +0.025/+0.051 | 25.400 +/-0.127 | BP0079-0111-0254-BSLT |
| 7.938 (0.313") +0.013/+0.038 (mm) | 11.113 +0.013/+0.038 | 25.400 +/-0.127 | BP0079-0111-0254-BSLL |
| 7.938 (0.313") +0.025/+0.051 (mm) | 11.113 +0.038/+0.064 | 25.400 +/-0.127 | BP0079-0111-0254-BSTT |
| 7.938 (0.313") +0.025/+0.051 (mm) | 11.113 +0.051/+0.076 | 25.400 +/-0.127 | BP0079-0111-0254-BSTH |
| 7.938 (0.313") +0.000/+0.025 (mm) | 11.113 +0.025/+0.051 | 28.575 +/-0.127 | BP0079-0111-0286-BSLT |
| 7.938 (0.313") +0.025/+0.051 (mm) | 11.113 +0.038/+0.064 | 28.575 +/-0.127 | BP0079-0111-0286-BSTT |
| 7.938 (0.313") +0.025/+0.051 (mm) | 11.113 +0.051/+0.076 | 28.575 +/-0.127 | BP0079-0111-0286-BSTH |
| 7.938 (0.313") +0.000/+0.025 (mm) | 11.113 +0.025/+0.051 | 31.750 +/-0.127 | BP0079-0111-0318-BSLT |
| 7.938 (0.313") +0.013/+0.038 (mm) | 11.113 +0.013/+0.038 | 31.750 +/-0.127 | BP0079-0111-0318-BSLL |
| 7.938 (0.313") +0.025/+0.051 (mm) | 11.113 +0.038/+0.064 | 31.750 +/-0.127 | BP0079-0111-0318-BSTT |



Stocked or Short Delivery



Usually Available Short Delivery



Long delivery or not in current production

* Large Minimum Quantities

** Available only while stock lasts

Bushes - Plain

| Nominal ID (d) mm (inches) | Nominal OD (D) mm | Length (S) mm | Part Number |
|--------------------------------------|-------------------------|--------------------|------------------------------|
| 7.938 (0.313") +0.025/+0.051 (mm) | 11.113 +0.051/+0.076 | 31.750 +/-0.127 | BP0079-0111-0318-BSTH |
| 7.938 (0.313") +0.000/+0.025 (mm) | 11.113 +0.025/+0.051 | 34.925 +/-0.127 | BP0079-0111-0349-BSLT |
| 7.938 (0.313") +0.013/+0.038 (mm) | 11.113 +0.013/+0.038 | 34.925 +/-0.127 | BP0079-0111-0349-BSLL |
| 7.938 (0.313") +0.013/+0.038 (mm) | 12.700 +0.051/+0.076 | 6.350 | BP0079-0127-0064-BSLH |
| 7.938 (0.313") +0.025/+0.051 (mm) | 12.700 +0.051/+0.076 | 6.350 +/-0.127 | BP0079-0127-0064-BSTH |
| 7.938 (0.313") +0.013/+0.038 (mm) | 12.700 +0.051/+0.076 | 7.925 +/-0.127 | BP0079-0127-0079-BSLH |
| 7.938 (0.313") +0.013/+0.038 (mm) | 12.700 +0.025/+0.051 | 9.525 +/-0.127 | BP0079-0127-0095-BSLT |
| 7.938 (0.313") +0.013/+0.038 (mm) | 12.700 +0.051/+0.076 | 9.525 +/-0.127 | BP0079-0127-0095-BSLH |
| 7.938 (0.313") +0.025/+0.051 (mm) | 12.700 +0.051/+0.076 | 9.525 +/-0.127 | BP0079-0127-0095-BSTH |
| 7.938 (0.313") -0.025/+0.000 (mm) | 12.700 +0.051/+0.076 | 9.525 +/-0.127 | BP0079-0127-0095-BSUH |
| 7.938 (0.313") +0.013/+0.038 (mm) | 12.700 +0.051/+0.076 | 11.100 +/-0.127 | BP0079-0127-0111-BSLH |
| 7.938 (0.313") +0.013/+0.038 (mm) | 12.700 +0.025/+0.051 | 12.700 +/-0.127 | BP0079-0127-0127-BSLT |
| 7.938 (0.313") +0.013/+0.038 (mm) | 12.700 +0.051/+0.076 | 12.700 +/-0.127 | BP0079-0127-0127-BSLH |
| 7.938 (0.313") +0.025/+0.051 (mm) | 12.700 +0.051/+0.076 | 12.700 +/-0.127 | BP0079-0127-0127-BSTH |
| 7.938 (0.313") -0.025/+0.000 (mm) | 12.700 +0.051/+0.076 | 12.700 +/-0.127 | BP0079-0127-0127-BSUH |
| 7.938 (0.313") +0.013/+0.038 (mm) | 12.700 +0.051/+0.076 | 14.288 +/-0.127 | BP0079-0127-0143-BSLH |
| 7.938 (0.313") +0.013/+0.038 (mm) | 12.700 +0.025/+0.051 | 15.875 +/-0.127 | BP0079-0127-0159-BSLT |
| 7.938 (0.313") +0.013/+0.038 (mm) | 12.700 +0.051/+0.076 | 15.875 +/-0.127 | BP0079-0127-0159-BSLH |
| 7.938 (0.313") +0.025/+0.051 (mm) | 12.700 +0.051/+0.076 | 15.875 +/-0.127 | BP0079-0127-0159-BSTH |
| 7.938 (0.313") -0.025/+0.000 (mm) | 12.700 +0.051/+0.076 | 15.875 +/-0.127 | BP0079-0127-0159-BSUH |
| 7.938 (0.313") +0.013/+0.038 (mm) | 12.700 +0.051/+0.076 | 17.856 +/-0.127 | BP0079-0127-0179-BSLH |
| 7.938 (0.313") +0.013/+0.038 (mm) | 12.700 +0.025/+0.051 | 19.050 +/-0.127 | BP0079-0127-0191-BSLT |
| 7.938 (0.313") +0.013/+0.038 (mm) | 12.700 +0.051/+0.076 | 19.050 +/-0.127 | BP0079-0127-0191-BSLH |
| 7.938 (0.313") +0.025/+0.051 (mm) | 12.700 +0.051/+0.076 | 19.050 +/-0.127 | BP0079-0127-0191-BSTH |
| 7.938 (0.313") -0.025/+0.000 (mm) | 12.700 +0.051/+0.076 | 19.050 +/-0.127 | BP0079-0127-0191-BSUH |
| 7.938 (0.313") +0.013/+0.038 (mm) | 12.700 +0.025/+0.051 | 22.225 +/-0.127 | BP0079-0127-0222-BSLT |
| 7.938 (0.313") +0.025/+0.051 (mm) | 12.700 +0.051/+0.076 | 22.225 +/-0.127 | BP0079-0127-0222-BSTH |
| 7.938 (0.313") -0.025/+0.000 (mm) | 12.700 +0.051/+0.076 | 22.225 +/-0.127 | BP0079-0127-0222-BSUH |
| 7.938 (0.313") +0.013/+0.038 (mm) | 12.700 +0.025/+0.051 | 25.400 +/-0.127 | BP0079-0127-0254-BSLT |
| 7.938 (0.313") +0.013/+0.038 (mm) | 12.700 +0.051/+0.076 | 25.400 +/-0.127 | BP0079-0127-0254-BSLH |
| 7.938 (0.313") +0.025/+0.051 (mm) | 12.700 +0.051/+0.076 | 25.400 +/-0.127 | BP0079-0127-0254-BSTH |
| 7.938 (0.313") -0.025/+0.000 (mm) | 12.700 +0.051/+0.076 | 25.400 +/-0.127 | BP0079-0127-0254-BSUH |
| 7.938 (0.313") +0.013/+0.038 (mm) | 12.700 +0.025/+0.051 | 31.750 +/-0.127 | BP0079-0127-0318-BSLT |
| 7.938 (0.313") +0.025/+0.051 (mm) | 12.700 +0.051/+0.076 | 31.750 +/-0.127 | BP0079-0127-0318-BSTH |



Stocked or Short Delivery



Usually Available Short Delivery



Long delivery or not in current production

* Large Minimum Quantities

** Available only while stock lasts

Bushes - Plain

| Nominal ID (d) mm (inches) | Nominal OD (D) mm | Length (S) mm | Part Number |
|--------------------------------------|-------------------------|---------------------|------------------------------|
| 7.938 (0.313") +0.013/+0.038 (mm) | 12.700 +0.025/+0.051 | 38.100 +/-0.127 | BP0079-0127-0381-BSLT |
| 7.938 (0.313") +0.025/+0.051 (mm) | 12.700 +0.051/+0.076 | 38.100 +/-0.127 | BP0079-0127-0381-BSTH |
| 7.938 (0.313") +0.013/+0.038 (mm) | 12.700 +0.025/+0.051 | 44.450 +/-0.190 | BP0079-0127-0445-BSLT |
| 7.938 (0.313") +0.000/+0.010 (mm) | 17.463 -0.010/+0.003 | 6.350 +0/-0.127 | BP0079-0175-0064-BSLU |
| 8.000 (0.315") +0.005/+0.030 (mm) | 10.000 +0.019/+0.040 | 8.000 +/-0.120 | BP0080-0100-0080-BSLL |
| 8.000 (0.315") +0.005/+0.030 (mm) | 10.000 +0.019/+0.040 | 10.000 +/-0.120 | BP0080-0100-0100-BSLL |
| 8.000 (0.315") +0.005/+0.030 (mm) | 11.000 +0.028/+0.050 | 8.000 +/-0.127 | BP0080-0110-0080-BSLT |
| 8.000 (0.315") +0.005/+0.030 (mm) | 11.000 +0.028/+0.050 | 12.000 +/-0.127 | BP0080-0110-0120-BSLT |
| 8.000 (0.315") +0.005/+0.030 (mm) | 11.000 +0.028/+0.050 | 16.000 +/-0.120 | BP0080-0110-0160-BSLT |
| 8.000 (0.315") +0.005/+0.030 (mm) | 11.000 +0.028/+0.050 | 20.000 +/-0.120 | BP0080-0110-0200-BSLT |
| 8.000 (0.315") +0.005/+0.040 (mm) | 12.000 +0.028/+0.050 | 6.000 +0/-0.200 | BP0080-0120-0060-BSLT |
| 8.000 (0.315") +0.005/+0.040 (mm) | 12.000 +0.028/+0.050 | 8.000 +0/-0.200 | BP0080-0120-0080-BSLT |
| 8.000 (0.315") +0.005/+0.030 (mm) | 12.000 +0.028/+0.050 | 10.000 +/-0.120 | BP0080-0120-0100-BSLT |
| 8.000 (0.315") +0.005/+0.040 (mm) | 12.000 +0.028/+0.050 | 12.000 +0/-0.200 | BP0080-0120-0120-BSLT |
| 8.000 (0.315") +0.005/+0.030 (mm) | 12.000 +0.028/+0.050 | 14.000 +/-0.120 | BP0080-0120-0140-BSLT |
| 8.000 (0.315") +0.005/+0.030 (mm) | 12.000 +0.028/+0.050 | 16.000 +/-0.127 | BP0080-0120-0160-BSLT |
| 8.000 (0.315") +0.005/+0.030 (mm) | 12.000 +0.028/+0.050 | 20.000 +/-0.127 | BP0080-0120-0200-BSLT |
| 8.000 (0.315") +0.005/+0.040 (mm) | 14.000 +0.028/+0.050 | 8.000 +0/-0.200 | BP0080-0140-0080-BSLT |
| 8.000 (0.315") +0.005/+0.040 (mm) | 14.000 +0.028/+0.050 | 12.000 +0/-0.200 | BP0080-0140-0120-BSLT |
| 8.000 (0.315") +0.005/+0.030 (mm) | 14.000 +0.028/+0.050 | 14.000 +/-0.120 | BP0080-0140-0140-BSLT |
| 8.000 (0.315") +0.005/+0.040 (mm) | 14.000 +0.028/+0.050 | 16.000 +0/-0.200 | BP0080-0140-0160-BSLT |
| 8.000 (0.315") +0.005/+0.030 (mm) | 14.000 +0.028/+0.050 | 20.000 +/-0.120 | BP0080-0140-0200-BSLT |
| 8.000 (0.315") +0.000/+0.015 (mm) | 16.000 -0.011/+0.000 | 6.000 +0/-0.170 | BP0080-0160-0060-BSLU |
| 8.334 (0.328") +0.000/+0.025 (mm) | 11.906 +0.058/+0.084 | 12.700 +/-0.127 | BP0083-0119-0127-BSLH |
| 8.334 (0.328") +0.000/+0.025 (mm) | 11.906 +0.058/+0.084 | 19.050 +/-0.127 | BP0083-0119-0191-BSLH |
| 8.334 (0.328") +0.000/+0.025 (mm) | 12.700 +0.051/+0.076 | 11.100 +/-0.127 | BP0083-0127-0111-BSLH |
| 9.000 (0.354") +0.005/+0.030 (mm) | 12.000 +0.025/+0.051 | 6.000 +/-0.120 | BP0090-0120-0060-BSLT |
| 9.000 (0.354") +0.005/+0.030 (mm) | 12.000 +0.025/+0.051 | 10.000 +/-0.127 | BP0090-0120-0100-BSLT |
| 9.000 (0.354") +0.005/+0.030 (mm) | 12.000 +0.025/+0.051 | 14.000 +/-0.127 | BP0090-0120-0140-BSLT |
| 9.000 (0.354") +0.005/+0.030 (mm) | 14.000 +0.025/+0.051 | 14.000 +/-0.127 | BP0090-0140-0140-BSLT |
| 9.525 (0.375") +0.013/+0.038 (mm) | 11.113 +0.038/+0.064 | 6.350 +/-0.127 | BP0095-0111-0064-BSLT |
| 9.525 (0.375") +0.013/+0.038 (mm) | 11.113 +0.038/+0.064 | 9.525 +/-0.127 | BP0095-0111-0095-BSLT |
| 9.525 (0.375") +0.013/+0.038 (mm) | 11.113 +0.038/+0.064 | 12.700 +/-0.127 | BP0095-0111-0127-BSLT |
| 9.525 (0.375") +0.025/+0.051 (mm) | 11.113 +0.038/+0.064 | 12.700 +/-0.127 | BP0095-0111-0127-BSTT |

Stocked or Short Delivery
 Usually Available Short Delivery
 Long delivery or not in current production

* Large Minimum Quantities

** Available only while stock lasts

Bushes - Plain

| Nominal ID (d) mm (inches) | Nominal OD (D) mm | Length (S) mm | Part Number |
|--------------------------------------|-------------------------|--------------------|------------------------------|
| 9.525 (0.375") +0.025/+0.051 (mm) | 11.113 +0.051/+0.076 | 12.700 +/-0.127 | BP0095-0111-0127-BSTH |
| 9.525 (0.375") +0.025/+0.051 (mm) | 11.113 +0.038/+0.064 | 15.875 +/-0.127 | BP0095-0111-0159-BSTT |
| 9.525 (0.375") +0.025/+0.051 (mm) | 11.113 +0.051/+0.076 | 15.875 +/-0.127 | BP0095-0111-0159-BSTH |
| 9.525 (0.375") +0.013/+0.038 (mm) | 11.113 +0.038/+0.064 | 19.050 +/-0.127 | BP0095-0111-0191-BSLT |
| 9.525 (0.375") +0.025/+0.051 (mm) | 11.113 +0.038/+0.064 | 19.050 +/-0.127 | BP0095-0111-0191-BSTT |
| 9.525 (0.375") +0.025/+0.051 (mm) | 11.113 +0.051/+0.076 | 19.050 +/-0.127 | BP0095-0111-0191-BSTH |
| 9.525 (0.375") +0.025/+0.051 (mm) | 11.113 +0.038/+0.064 | 25.400 +/-0.127 | BP0095-0111-0254-BSTT |
| 9.525 (0.375") +0.025/+0.051 (mm) | 11.113 +0.051/+0.076 | 25.400 +/-0.127 | BP0095-0111-0254-BSTH |
| 9.525 (0.375") +0.013/+0.038 (mm) | 12.700 +0.051/+0.076 | 4.750 | BP0095-0127-0048-BSLH |
| 9.525 (0.375") +0.025/+0.051 (mm) | 12.700 +0.051/+0.076 | 4.750 +0/-0.102 | BP0095-0127-0048-BSTH |
| 9.525 (0.375") +0.013/+0.038 (mm) | 12.700 +0.051/+0.076 | 6.350 +/-0.127 | BP0095-0127-0064-BSLH |
| 9.525 (0.375") +0.025/+0.051 (mm) | 12.700 +0.051/+0.076 | 6.350 +/-0.127 | BP0095-0127-0064-BSTH |
| 9.525 (0.375") +0.051/+0.076 (mm) | 12.700 +0.038/+0.064 | 6.350 +/-0.127 | BP0095-0127-0064-BSHT |
| 9.525 (0.375") +0.051/+0.076 (mm) | 12.700 +0.051/+0.076 | 6.350 +/-0.127 | BP0095-0127-0064-BSHH |
| 9.525 (0.375") -0.025/+0.000 (mm) | 12.700 +0.051/+0.076 | 6.350 +/-0.127 | BP0095-0127-0064-BSUH |
| 9.525 (0.375") +0.013/+0.038 (mm) | 12.700 +0.051/+0.076 | 7.938 +/-0.127 | BP0095-0127-0079-BSLH |
| 9.525 (0.375") +0.025/+0.051 (mm) | 12.700 +0.051/+0.076 | 7.938 +/-0.127 | BP0095-0127-0079-BSTH |
| 9.525 (0.375") +0.013/+0.038 (mm) | 12.700 +0.051/+0.076 | 9.525 +/-0.127 | BP0095-0127-0095-BSLH |
| 9.525 (0.375") +0.025/+0.051 (mm) | 12.700 +0.025/+0.051 | 9.525 +/-0.127 | BP0095-0127-0095-BSTT |
| 9.525 (0.375") +0.025/+0.051 (mm) | 12.700 +0.051/+0.076 | 9.525 +/-0.127 | BP0095-0127-0095-BSTH |
| 9.525 (0.375") +0.051/+0.076 (mm) | 12.700 +0.051/+0.076 | 9.525 +/-0.127 | BP0095-0127-0095-BSHH |
| 9.525 (0.375") -0.025/+0.000 (mm) | 12.700 +0.051/+0.076 | 9.525 +/-0.127 | BP0095-0127-0095-BSUH |
| 9.525 (0.375") +0.013/+0.038 (mm) | 12.700 +0.051/+0.076 | 11.113 +/-0.127 | BP0095-0127-0111-BSLH |
| 9.525 (0.375") +0.025/+0.051 (mm) | 12.700 +0.051/+0.076 | 11.113 +/-0.127 | BP0095-0127-0111-BSTH |
| 9.525 (0.375") -0.025/+0.000 (mm) | 12.700 +0.051/+0.076 | 11.113 +/-0.127 | BP0095-0127-0111-BSUH |
| 9.525 (0.375") +0.013/+0.038 (mm) | 12.700 +0.051/+0.076 | 12.700 +/-0.127 | BP0095-0127-0127-BSLH |
| 9.525 (0.375") +0.025/+0.051 (mm) | 12.700 +0.025/+0.051 | 12.700 +/-0.127 | BP0095-0127-0127-BSTT |
| 9.525 (0.375") +0.025/+0.051 (mm) | 12.700 +0.051/+0.076 | 12.700 +/-0.127 | BP0095-0127-0127-BSTH |
| 9.525 (0.375") +0.051/+0.076 (mm) | 12.700 +0.038/+0.064 | 12.700 +/-0.127 | BP0095-0127-0127-BSHT |
| 9.525 (0.375") +0.051/+0.076 (mm) | 12.700 +0.051/+0.076 | 12.700 +/-0.127 | BP0095-0127-0127-BSHH |
| 9.525 (0.375") -0.025/+0.000 (mm) | 12.700 +0.051/+0.076 | 12.700 +/-0.127 | BP0095-0127-0127-BSUH |
| 9.525 (0.375") +0.013/+0.038 (mm) | 12.700 +0.051/+0.076 | 15.875 +/-0.127 | BP0095-0127-0159-BSLH |
| 9.525 (0.375") +0.025/+0.051 (mm) | 12.700 +0.025/+0.051 | 15.875 +/-0.127 | BP0095-0127-0159-BSTT |
| 9.525 (0.375") +0.025/+0.051 (mm) | 12.700 +0.051/+0.076 | 15.875 +/-0.127 | BP0095-0127-0159-BSTH |



Stocked or Short Delivery



Usually Available Short Delivery



Long delivery or not in current production

* Large Minimum Quantities

** Available only while stock lasts

Bushes - Plain

| Nominal ID (d) mm (inches) | Nominal OD (D) mm | Length (S) mm | Part Number |
|--------------------------------------|-------------------------|--------------------|------------------------------|
| 9.525 (0.375") +0.051/+0.076 (mm) | 12.700 +0.038/+0.064 | 15.875 +/-0.127 | BP0095-0127-0159-BSHT |
| 9.525 (0.375") +0.051/+0.076 (mm) | 12.700 +0.051/+0.076 | 15.875 +/-0.127 | BP0095-0127-0159-BSHH |
| 9.525 (0.375") -0.025/+0.000 (mm) | 12.700 +0.051/+0.076 | 15.875 +/-0.127 | BP0095-0127-0159-BSUH |
| 9.525 (0.375") +0.013/+0.038 (mm) | 12.700 +0.051/+0.076 | 19.050 +/-0.127 | BP0095-0127-0191-BSLH |
| 9.525 (0.375") +0.025/+0.051 (mm) | 12.700 +0.025/+0.051 | 19.050 +/-0.127 | BP0095-0127-0191-BSTT |
| 9.525 (0.375") +0.025/+0.051 (mm) | 12.700 +0.051/+0.076 | 19.050 +/-0.127 | BP0095-0127-0191-BSTH |
| 9.525 (0.375") +0.051/+0.076 (mm) | 12.700 +0.038/+0.064 | 19.050 +/-0.127 | BP0095-0127-0191-BSHT |
| 9.525 (0.375") +0.051/+0.076 (mm) | 12.700 +0.051/+0.076 | 19.050 +/-0.127 | BP0095-0127-0191-BSHH |
| 9.525 (0.375") -0.025/+0.000 (mm) | 12.700 +0.051/+0.076 | 19.050 +/-0.127 | BP0095-0127-0191-BSUH |
| 9.525 (0.375") +0.025/+0.051 (mm) | 12.700 +0.051/+0.076 | 20.650 +/-0.127 | BP0095-0127-0207-BSTH |
| 9.525 (0.375") +0.013/+0.038 (mm) | 12.700 +0.051/+0.076 | 22.225 +/-0.127 | BP0095-0127-0222-BSLH |
| 9.525 (0.375") +0.025/+0.051 (mm) | 12.700 +0.025/+0.051 | 22.225 +/-0.127 | BP0095-0127-0222-BSTT |
| 9.525 (0.375") +0.025/+0.051 (mm) | 12.700 +0.051/+0.076 | 22.225 +/-0.127 | BP0095-0127-0222-BSTH |
| 9.525 (0.375") +0.051/+0.076 (mm) | 12.700 +0.051/+0.076 | 22.225 +/-0.127 | BP0095-0127-0222-BSHH |
| 9.525 (0.375") -0.025/+0.000 (mm) | 12.700 +0.051/+0.076 | 22.225 +/-0.127 | BP0095-0127-0222-BSUH |
| 9.525 (0.375") +0.013/+0.038 (mm) | 12.700 +0.051/+0.076 | 25.400 +/-0.127 | BP0095-0127-0254-BSLH |
| 9.525 (0.375") +0.025/+0.051 (mm) | 12.700 +0.025/+0.051 | 25.400 +/-0.127 | BP0095-0127-0254-BSTT |
| 9.525 (0.375") +0.025/+0.051 (mm) | 12.700 +0.051/+0.076 | 25.400 +/-0.127 | BP0095-0127-0254-BSTH |
| 9.525 (0.375") +0.051/+0.076 (mm) | 12.700 +0.038/+0.064 | 25.400 +/-0.127 | BP0095-0127-0254-BSHT |
| 9.525 (0.375") +0.051/+0.076 (mm) | 12.700 +0.051/+0.076 | 25.400 +/-0.127 | BP0095-0127-0254-BSHH |
| 9.525 (0.375") -0.025/+0.000 (mm) | 12.700 +0.051/+0.076 | 25.400 +/-0.127 | BP0095-0127-0254-BSUH |
| 9.525 (0.375") +0.013/+0.038 (mm) | 12.700 +0.051/+0.076 | 28.575 +/-0.127 | BP0095-0127-0286-BSLH |
| 9.525 (0.375") +0.025/+0.051 (mm) | 12.700 +0.051/+0.076 | 28.575 +/-0.127 | BP0095-0127-0286-BSTH |
| 9.525 (0.375") +0.051/+0.076 (mm) | 12.700 +0.051/+0.076 | 28.575 +/-0.127 | BP0095-0127-0286-BSHH |
| 9.525 (0.375") +0.025/+0.051 (mm) | 12.700 +0.025/+0.051 | 31.750 +/-0.127 | BP0095-0127-0318-BSTT |
| 9.525 (0.375") +0.025/+0.051 (mm) | 12.700 +0.051/+0.076 | 31.750 +/-0.127 | BP0095-0127-0318-BSTH |
| 9.525 (0.375") +0.051/+0.076 (mm) | 12.700 +0.051/+0.076 | 31.750 +/-0.127 | BP0095-0127-0318-BSHH |
| 9.525 (0.375") -0.025/+0.000 (mm) | 12.700 +0.051/+0.076 | 31.750 +/-0.127 | BP0095-0127-0318-BSUH |
| 9.525 (0.375") +0.025/+0.051 (mm) | 14.288 +0.051/+0.076 | 8.331 +/-0.127 | BP0095-0143-0083-BSTH |
| 9.525 (0.375") +0.013/+0.038 (mm) | 14.288 +0.051/+0.076 | 9.525 | BP0095-0143-0095-BSLH |
| 9.525 (0.375") +0.025/+0.051 (mm) | 14.288 +0.025/+0.051 | 9.525 +/-0.127 | BP0095-0143-0095-BSTT |
| 9.525 (0.375") +0.025/+0.051 (mm) | 14.288 +0.051/+0.076 | 9.525 +/-0.127 | BP0095-0143-0095-BSTH |
| 9.525 (0.375") +0.051/+0.076 (mm) | 14.288 +0.038/+0.064 | 9.525 +/-0.127 | BP0095-0143-0095-BSHT |
| 9.525 (0.375") +0.013/+0.038 (mm) | 14.288 +0.051/+0.076 | 12.700 | BP0095-0143-0127-BSLH |



Stocked or Short Delivery



Usually Available Short Delivery



Long delivery or not in current production

* Large Minimum Quantities

** Available only while stock lasts

Bushes - Plain

| Nominal ID (d) mm (inches) | Nominal OD (D) mm | Length (S) mm | Part Number |
|--------------------------------------|-------------------------|--------------------|------------------------------|
| 9.525 (0.375") +0.025/+0.051 (mm) | 14.288 +0.025/+0.051 | 12.700 +/-0.127 | BP0095-0143-0127-BSTT |
| 9.525 (0.375") +0.025/+0.051 (mm) | 14.288 +0.051/+0.076 | 12.700 +/-0.127 | BP0095-0143-0127-BSTH |
| 9.525 (0.375") +0.051/+0.076 (mm) | 14.288 +0.038/+0.064 | 12.700 +/-0.127 | BP0095-0143-0127-BSHT |
| 9.525 (0.375") +0.013/+0.038 (mm) | 14.288 +0.051/+0.076 | 14.288 +/-0.127 | BP0095-0143-0143-BSLH |
| 9.525 (0.375") +0.025/+0.051 (mm) | 14.288 +0.025/+0.051 | 15.875 +/-0.127 | BP0095-0143-0159-BSTT |
| 9.525 (0.375") +0.025/+0.051 (mm) | 14.288 +0.051/+0.076 | 15.875 +/-0.127 | BP0095-0143-0159-BSTH |
| 9.525 (0.375") +0.051/+0.076 (mm) | 14.288 +0.038/+0.064 | 15.875 +/-0.127 | BP0095-0143-0159-BSHT |
| 9.525 (0.375") +0.013/+0.038 (mm) | 14.288 +0.051/+0.076 | 17.463 +/-0.127 | BP0095-0143-0175-BSLH |
| 9.525 (0.375") +0.013/+0.038 (mm) | 14.288 +0.051/+0.076 | 19.050 +/-0.127 | BP0095-0143-0191-BSLH |
| 9.525 (0.375") +0.025/+0.051 (mm) | 14.288 +0.025/+0.051 | 19.050 +/-0.127 | BP0095-0143-0191-BSTT |
| 9.525 (0.375") +0.025/+0.051 (mm) | 14.288 +0.051/+0.076 | 19.050 +/-0.127 | BP0095-0143-0191-BSTH |
| 9.525 (0.375") +0.051/+0.076 (mm) | 14.288 +0.038/+0.064 | 19.050 +/-0.127 | BP0095-0143-0191-BSHT |
| 9.525 (0.375") +0.025/+0.051 (mm) | 14.288 +0.051/+0.076 | 19.177 +/-0.127 | BP0095-0143-0192-BSTH |
| 9.525 (0.375") +0.025/+0.051 (mm) | 14.288 +0.025/+0.051 | 22.225 +/-0.127 | BP0095-0143-0222-BSTT |
| 9.525 (0.375") +0.025/+0.051 (mm) | 14.288 +0.051/+0.076 | 22.225 +/-0.127 | BP0095-0143-0222-BSTH |
| 9.525 (0.375") +0.051/+0.076 (mm) | 14.288 +0.038/+0.064 | 22.225 +/-0.127 | BP0095-0143-0222-BSHT |
| 9.525 (0.375") +0.025/+0.051 (mm) | 14.288 +0.051/+0.076 | 25.273 +/-0.127 | BP0095-0143-0253-BSTH |
| 9.525 (0.375") +0.013/+0.038 (mm) | 14.288 +0.051/+0.076 | 25.400 +/-0.127 | BP0095-0143-0254-BSLH |
| 9.525 (0.375") +0.025/+0.051 (mm) | 14.288 +0.025/+0.051 | 25.400 +/-0.127 | BP0095-0143-0254-BSTT |
| 9.525 (0.375") +0.025/+0.051 (mm) | 14.288 +0.051/+0.076 | 25.400 +/-0.127 | BP0095-0143-0254-BSTH |
| 9.525 (0.375") +0.051/+0.076 (mm) | 14.288 +0.038/+0.064 | 25.400 +/-0.127 | BP0095-0143-0254-BSHT |
| 9.525 (0.375") +0.013/+0.038 (mm) | 14.288 +0.051/+0.076 | 31.750 +/-0.127 | BP0095-0143-0318-BSLH |
| 9.525 (0.375") +0.025/+0.051 (mm) | 14.288 +0.025/+0.051 | 31.750 +/-0.127 | BP0095-0143-0318-BSTT |
| 9.525 (0.375") +0.025/+0.051 (mm) | 14.288 +0.051/+0.076 | 31.750 +/-0.127 | BP0095-0143-0318-BSTH |
| 9.525 (0.375") +0.051/+0.076 (mm) | 14.288 +0.038/+0.064 | 31.750 +/-0.127 | BP0095-0143-0318-BSHT |
| 9.525 (0.375") +0.025/+0.051 (mm) | 15.875 +0.051/+0.076 | 7.925 +/-0.127 | BP0095-0159-0079-BSTH |
| 9.525 (0.375") +0.000/+0.025 (mm) | 15.875 +0.025/+0.051 | 9.525 +/-0.127 | BP0095-0159-0095-BSLT |
| 9.525 (0.375") +0.025/+0.051 (mm) | 15.875 +0.025/+0.051 | 9.525 +/-0.127 | BP0095-0159-0095-BSTT |
| 9.525 (0.375") +0.025/+0.051 (mm) | 15.875 +0.051/+0.076 | 9.525 +/-0.127 | BP0095-0159-0095-BSTH |
| 9.525 (0.375") +0.051/+0.076 (mm) | 15.875 +0.051/+0.076 | 9.525 +/-0.127 | BP0095-0159-0095-BSHH |
| 9.525 (0.375") +0.025/+0.051 (mm) | 15.875 +0.051/+0.076 | 10.973 +/-0.127 | BP0095-0159-0110-BSTH |
| 9.525 (0.375") +0.000/+0.025 (mm) | 15.875 +0.025/+0.051 | 11.113 +/-0.127 | BP0095-0159-0111-BSLT |
| 9.525 (0.375") +0.000/+0.025 (mm) | 15.875 +0.025/+0.051 | 12.700 +/-0.127 | BP0095-0159-0127-BSLT |
| 9.525 (0.375") +0.025/+0.051 (mm) | 15.875 +0.025/+0.051 | 12.700 +/-0.127 | BP0095-0159-0127-BSTT |



Stocked or Short Delivery



Usually Available Short Delivery



Long delivery or not in current production

* Large Minimum Quantities

** Available only while stock lasts

Bushes - Plain

| Nominal ID (d) mm (inches) | Nominal OD (D) mm | Length (S) mm | Part Number |
|-------------------------------|----------------------|---------------|------------------------------|
| 9.525 (0.375") | 15.875 | 12.700 | BP0095-0159-0127-BSTH |
| +0.025/+0.051 (mm) | +0.051/+0.076 | +/-0.127 | |
| 9.525 (0.375") | 15.875 | 12.700 | BP0095-0159-0127-BSHH |
| +0.051/+0.076 (mm) | +0.051/+0.076 | +/-0.127 | |
| 9.525 (0.375") | 15.875 | 15.875 | BP0095-0159-0159-BSLT |
| +0.000/+0.025 (mm) | +0.025/+0.051 | | |
| 9.525 (0.375") | 15.875 | 15.875 | BP0095-0159-0159-BSTT |
| +0.025/+0.051 (mm) | +0.025/+0.051 | +/-0.127 | |
| 9.525 (0.375") | 15.875 | 15.875 | BP0095-0159-0159-BSHH |
| +0.051/+0.076 (mm) | +0.051/+0.076 | +/-0.127 | |
| 9.525 (0.375") | 15.875 | 15.926 | BP0095-0159-0160-BSTH |
| +0.025/+0.051 (mm) | +0.051/+0.076 | +0/-0.102 | |
| 9.525 (0.375") | 15.875 | 19.050 | BP0095-0159-0191-BSLT |
| +0.000/+0.025 (mm) | +0.025/+0.051 | | |
| 9.525 (0.375") | 15.875 | 19.050 | BP0095-0159-0191-BSTT |
| +0.025/+0.051 (mm) | +0.025/+0.051 | +/-0.127 | |
| 9.525 (0.375") | 15.875 | 19.050 | BP0095-0159-0191-BSTH |
| +0.025/+0.051 (mm) | +0.051/+0.076 | +/-0.127 | |
| 9.525 (0.375") | 15.875 | 19.050 | BP0095-0159-0191-BSHH |
| +0.051/+0.076 (mm) | +0.051/+0.076 | +/-0.127 | |
| 9.525 (0.375") | 15.875 | 22.225 | BP0095-0159-0222-BSLT |
| +0.000/+0.025 (mm) | +0.025/+0.051 | | |
| 9.525 (0.375") | 15.875 | 22.225 | BP0095-0159-0222-BSTT |
| +0.025/+0.051 (mm) | +0.025/+0.051 | +/-0.127 | |
| 9.525 (0.375") | 15.875 | 22.225 | BP0095-0159-0222-BSTH |
| +0.025/+0.051 (mm) | +0.051/+0.076 | +/-0.127 | |
| 9.525 (0.375") | 15.875 | 22.225 | BP0095-0159-0222-BSHH |
| +0.051/+0.076 (mm) | +0.051/+0.076 | +/-0.127 | |
| 9.525 (0.375") | 15.875 | 25.400 | BP0095-0159-0254-BSLT |
| +0.000/+0.025 (mm) | +0.025/+0.051 | | |
| 9.525 (0.375") | 15.875 | 25.400 | BP0095-0159-0254-BSTT |
| +0.025/+0.051 (mm) | +0.025/+0.051 | +/-0.127 | |
| 9.525 (0.375") | 15.875 | 25.400 | BP0095-0159-0254-BSTH |
| +0.025/+0.051 (mm) | +0.051/+0.076 | +/-0.127 | |
| 9.525 (0.375") | 15.875 | 25.400 | BP0095-0159-0254-BSHH |
| +0.051/+0.076 (mm) | +0.051/+0.076 | +/-0.127 | |
| 9.525 (0.375") | 15.875 | 28.575 | BP0095-0159-0286-BSLT |
| +0.000/+0.025 (mm) | +0.025/+0.051 | +/-0.127 | |
| 9.525 (0.375") | 15.875 | 31.750 | BP0095-0159-0318-BSLT |
| +0.000/+0.025 (mm) | +0.025/+0.051 | | |
| 9.525 (0.375") | 15.875 | 31.750 | BP0095-0159-0318-BSTT |
| +0.025/+0.051 (mm) | +0.025/+0.051 | +/-0.127 | |
| 9.525 (0.375") | 15.875 | 31.750 | BP0095-0159-0318-BSTH |
| +0.025/+0.051 (mm) | +0.051/+0.076 | +/-0.127 | |
| 9.525 (0.375") | 15.875 | 31.750 | BP0095-0159-0318-BSHH |
| +0.051/+0.076 (mm) | +0.051/+0.076 | +/-0.127 | |
| 9.525 (0.375") | 15.875 | 38.100 | BP0095-0159-0381-BSHH |
| +0.051/+0.076 (mm) | +0.051/+0.076 | +/-0.127 | |
| 9.525 (0.375") | 17.463 | 9.525 | BP0095-0175-0095-BSTH |
| +0.025/+0.051 (mm) | +0.051/+0.076 | +/-0.127 | |
| 9.525 (0.375") | 17.463 | 19.050 | BP0095-0175-0191-BSLL |
| +0.013/+0.038 (mm) | +0.013/+0.038 | +/-0.127 | |
| 9.525 (0.375") | 17.463 | 38.100 | BP0095-0175-0381-BSLL |
| +0.013/+0.038 (mm) | +0.013/+0.038 | +/-0.127 | |
| 9.525 (0.375") | 19.050 | 9.525 | BP0095-0191-0095-BSHH |
| +0.051/+0.076 (mm) | +0.051/+0.076 | +/-0.127 | |
| 9.525 (0.375") | 19.050 | 12.700 | BP0095-0191-0127-BSTH |
| +0.025/+0.051 (mm) | +0.051/+0.076 | +/-0.127 | |
| 9.525 (0.375") | 19.050 | 12.700 | BP0095-0191-0127-BSHH |
| +0.051/+0.076 (mm) | +0.051/+0.076 | +/-0.127 | |
| 9.525 (0.375") | 19.050 | 19.050 | BP0095-0191-0191-BSTH |
| +0.025/+0.051 (mm) | +0.051/+0.076 | | |
| 9.525 (0.375") | 19.050 | 19.050 | BP0095-0191-0191-BSHH |
| +0.051/+0.076 (mm) | +0.051/+0.076 | +/-0.127 | |
| 9.525 (0.375") | 19.050 | 25.400 | BP0095-0191-0254-BSTH |
| +0.025/+0.051 (mm) | +0.051/+0.076 | | |
| 9.525 (0.375") | 19.050 | 25.400 | BP0095-0191-0254-BSHH |
| +0.051/+0.076 (mm) | +0.051/+0.076 | +/-0.127 | |



Stocked or Short Delivery



Usually Available Short Delivery



Long delivery or not in current production

* Large Minimum Quantities

** Available only while stock lasts

Bushes - Plain

| Nominal ID (d) mm (inches) | Nominal OD (D) mm | Length (S) mm | Part Number |
|---------------------------------------|-------------------------|---------------------|------------------------------|
| 9.525 (0.375") +0.025/+0.051 (mm) | 19.050 +0.051/+0.076 | 31.750 | BP0095-0191-0318-BSTH |
| 9.525 (0.375") +0.051/+0.076 (mm) | 19.050 +0.051/+0.076 | 31.750 +/-0.127 | BP0095-0191-0318-BSHH |
| 9.525 (0.375") +0.000/+0.010 (mm) | 22.225 -0.010/+0.003 | 7.137 +0/-0.127 | BP0095-0222-0071-BSLU |
| 10.000 (0.394") +0.005/+0.030 (mm) | 12.000 +0.025/+0.051 | 10.000 +/-0.120 | BP0100-0120-0100-BSLT |
| 10.000 (0.394") +0.005/+0.030 (mm) | 12.000 +0.025/+0.051 | 11.000 +/-0.120 | BP0100-0120-0110-BSLT |
| 10.000 (0.394") +0.005/+0.030 (mm) | 12.000 +0.025/+0.051 | 20.000 +/-0.120 | BP0100-0120-0200-BSLT |
| 10.000 (0.394") +0.005/+0.030 (mm) | 13.000 +0.025/+0.051 | 10.000 +/-0.120 | BP0100-0130-0100-BSLT |
| 10.000 (0.394") +0.005/+0.030 (mm) | 13.000 +0.025/+0.051 | 12.000 +/-0.120 | BP0100-0130-0120-BSLT |
| 10.000 (0.394") +0.005/+0.030 (mm) | 13.000 +0.025/+0.051 | 16.000 +/-0.120 | BP0100-0130-0160-BSLT |
| 10.000 (0.394") +0.005/+0.030 (mm) | 13.000 +0.025/+0.051 | 18.000 +/-0.120 | BP0100-0130-0180-BSLT |
| 10.000 (0.394") +0.005/+0.030 (mm) | 13.000 +0.025/+0.051 | 20.000 +/-0.120 | BP0100-0130-0200-BSLT |
| 10.000 (0.394") +0.005/+0.030 (mm) | 13.000 +0.025/+0.051 | 25.000 +/-0.120 | BP0100-0130-0250-BSLT |
| 10.000 (0.394") +0.005/+0.030 (mm) | 14.000 +0.025/+0.051 | 8.000 +/-0.127 | BP0100-0140-0080-BSLT |
| 10.000 (0.394") +0.005/+0.030 (mm) | 14.000 +0.025/+0.051 | 10.000 +/-0.127 | BP0100-0140-0100-BSLT |
| 10.000 (0.394") +0.005/+0.030 (mm) | 14.000 +0.025/+0.051 | 14.000 +/-0.120 | BP0100-0140-0140-BSLT |
| 10.000 (0.394") +0.005/+0.030 (mm) | 14.000 +0.025/+0.051 | 15.000 +/-0.120 | BP0100-0140-0150-BSLT |
| 10.000 (0.394") +0.005/+0.030 (mm) | 14.000 +0.025/+0.051 | 16.000 +/-0.127 | BP0100-0140-0160-BSLT |
| 10.000 (0.394") +0.005/+0.030 (mm) | 14.000 +0.025/+0.051 | 18.000 +/-0.120 | BP0100-0140-0180-BSLT |
| 10.000 (0.394") +0.005/+0.030 (mm) | 14.000 +0.025/+0.051 | 20.000 +/-0.127 | BP0100-0140-0200-BSLT |
| 10.000 (0.394") +0.005/+0.030 (mm) | 14.000 +0.025/+0.051 | 25.000 +/-0.127 | BP0100-0140-0250-BSLT |
| 10.000 (0.394") +0.005/+0.030 (mm) | 15.000 +0.025/+0.051 | 10.000 +/-0.120 | BP0100-0150-0100-BSLT |
| 10.000 (0.394") +0.005/+0.030 (mm) | 15.000 +0.025/+0.051 | 16.000 +/-0.120 | BP0100-0150-0160-BSLT |
| 10.000 (0.394") +0.005/+0.030 (mm) | 15.000 +0.025/+0.051 | 20.000 +/-0.120 | BP0100-0150-0200-BSLT |
| 10.000 (0.394") +0.005/+0.030 (mm) | 15.000 +0.025/+0.051 | 25.000 +/-0.120 | BP0100-0150-0250-BSLT |
| 10.000 (0.394") +0.005/+0.030 (mm) | 16.000 +0.025/+0.051 | 8.000 +/-0.127 | BP0100-0160-0080-BSLT |
| 10.000 (0.394") +0.005/+0.030 (mm) | 16.000 +0.025/+0.051 | 10.000 +/-0.127 | BP0100-0160-0100-BSLT |
| 10.000 (0.394") +0.005/+0.030 (mm) | 16.000 +0.025/+0.051 | 15.000 +/-0.120 | BP0100-0160-0150-BSLT |
| 10.000 (0.394") +0.005/+0.030 (mm) | 16.000 +0.025/+0.051 | 16.000 +/-0.127 | BP0100-0160-0160-BSLT |
| 10.000 (0.394") +0.015/+0.041 (mm) | 16.000 +0.025/+0.051 | 20.000 +0/-0.200 | BP0100-0160-0200-BSLT |
| 10.000 (0.394") +0.005/+0.030 (mm) | 16.000 +0.025/+0.051 | 25.000 +/-0.127 | BP0100-0160-0250-BSLT |
| 10.000 (0.394") +0.000/+0.015 (mm) | 19.000 -0.013/+0.000 | 7.000 +0/-0.170 | BP0100-0190-0070-BSLU |
| 11.113 (0.438") +0.013/+0.038 (mm) | 14.288 +0.038/+0.064 | 7.938 +/-0.127 | BP0111-0143-0079-BSLT |
| 11.113 (0.438") +0.013/+0.038 (mm) | 14.288 +0.025/+0.051 | 9.525 +/-0.127 | BP0111-0143-0095-BSLT1 |
| 11.113 (0.438") +0.013/+0.038 (mm) | 14.288 +0.038/+0.064 | 9.525 +/-0.127 | BP0111-0143-0095-BSLT2 |

Stocked or Short Delivery
 Usually Available Short Delivery
 Long delivery or not in current production

* Large Minimum Quantities

** Available only while stock lasts

Bushes - Plain

| Nominal ID (d) mm (inches) | Nominal OD (D) mm | Length (S) mm | Part Number |
|---------------------------------------|-------------------------|--------------------|-------------------------------|
| 11.113 (0.438") +0.025/+0.051 (mm) | 14.288 +0.051/+0.076 | 9.525 +/-0.127 | BP0111-0143-0095-BSTH |
| 11.113 (0.438") +0.038/+0.064 (mm) | 14.288 +0.038/+0.064 | 9.525 +/-0.127 | BP0111-0143-0095-BSTT |
| 11.113 (0.438") +0.013/+0.038 (mm) | 14.288 +0.025/+0.051 | 12.700 +/-0.127 | BP0111-0143-0127-BSLT1 |
| 11.113 (0.438") +0.013/+0.038 (mm) | 14.288 +0.038/+0.064 | 12.700 +/-0.127 | BP0111-0143-0127-BSLT2 |
| 11.113 (0.438") +0.025/+0.051 (mm) | 14.288 +0.051/+0.076 | 12.700 +/-0.127 | BP0111-0143-0127-BSTH |
| 11.113 (0.438") +0.038/+0.064 (mm) | 14.288 +0.038/+0.064 | 12.700 +/-0.127 | BP0111-0143-0127-BSTT |
| 11.113 (0.438") +0.013/+0.038 (mm) | 14.288 +0.025/+0.051 | 15.875 +/-0.127 | BP0111-0143-0159-BSLT1 |
| 11.113 (0.438") +0.013/+0.038 (mm) | 14.288 +0.038/+0.064 | 15.875 +/-0.127 | BP0111-0143-0159-BSLT2 |
| 11.113 (0.438") +0.025/+0.051 (mm) | 14.288 +0.051/+0.076 | 15.875 +/-0.127 | BP0111-0143-0159-BSTH |
| 11.113 (0.438") +0.038/+0.064 (mm) | 14.288 +0.038/+0.064 | 15.875 +/-0.127 | BP0111-0143-0159-BSTT |
| 11.113 (0.438") +0.051/+0.076 (mm) | 14.288 +0.051/+0.076 | 18.110 +/-0.127 | BP0111-0143-0181-BSHH |
| 11.113 (0.438") +0.013/+0.038 (mm) | 14.288 +0.025/+0.051 | 19.050 +/-0.127 | BP0111-0143-0191-BSLT1 |
| 11.113 (0.438") +0.013/+0.038 (mm) | 14.288 +0.038/+0.064 | 19.050 +/-0.127 | BP0111-0143-0191-BSLT2 |
| 11.113 (0.438") +0.025/+0.051 (mm) | 14.288 +0.051/+0.076 | 19.050 +/-0.127 | BP0111-0143-0191-BSTH |
| 11.113 (0.438") +0.038/+0.064 (mm) | 14.288 +0.038/+0.064 | 19.050 +/-0.127 | BP0111-0143-0191-BSTT |
| 11.113 (0.438") +0.013/+0.038 (mm) | 14.288 +0.038/+0.064 | 20.638 +/-0.127 | BP0111-0143-0206-BSLT |
| 11.113 (0.438") +0.013/+0.038 (mm) | 14.288 +0.025/+0.051 | 22.225 +/-0.127 | BP0111-0143-0222-BSLT |
| 11.113 (0.438") +0.025/+0.051 (mm) | 14.288 +0.051/+0.076 | 22.225 +/-0.127 | BP0111-0143-0222-BSTH |
| 11.113 (0.438") +0.038/+0.064 (mm) | 14.288 +0.038/+0.064 | 22.225 +/-0.127 | BP0111-0143-0222-BSTT |
| 11.113 (0.438") +0.013/+0.038 (mm) | 14.288 +0.038/+0.064 | 23.813 +/-0.127 | BP0111-0143-0238-BSLT |
| 11.113 (0.438") +0.013/+0.038 (mm) | 14.288 +0.025/+0.051 | 25.400 +/-0.127 | BP0111-0143-0254-BSLT1 |
| 11.113 (0.438") +0.013/+0.038 (mm) | 14.288 +0.038/+0.064 | 25.400 +/-0.127 | BP0111-0143-0254-BSLT2 |
| 11.113 (0.438") +0.025/+0.051 (mm) | 14.288 +0.051/+0.076 | 25.400 +/-0.127 | BP0111-0143-0254-BSTH |
| 11.113 (0.438") +0.038/+0.064 (mm) | 14.288 +0.038/+0.064 | 25.400 +/-0.127 | BP0111-0143-0254-BSTT |
| 11.113 (0.438") +0.013/+0.038 (mm) | 14.288 +0.025/+0.051 | 31.750 +/-0.127 | BP0111-0143-0318-BSLT |
| 11.113 (0.438") +0.025/+0.051 (mm) | 14.288 +0.051/+0.076 | 31.750 +/-0.127 | BP0111-0143-0318-BSTH |
| 11.113 (0.438") +0.038/+0.064 (mm) | 14.288 +0.038/+0.064 | 31.750 +/-0.127 | BP0111-0143-0318-BSTT |
| 11.113 (0.438") +0.013/+0.038 (mm) | 15.875 +0.025/+0.051 | 9.525 +/-0.127 | BP0111-0159-0095-BSLT |
| 11.113 (0.438") +0.013/+0.038 (mm) | 15.875 +0.051/+0.076 | 9.525 +/-0.127 | BP0111-0159-0095-BSLH |
| 11.113 (0.438") +0.025/+0.051 (mm) | 15.875 +0.051/+0.076 | 9.525 +/-0.127 | BP0111-0159-0095-BSTH1 |
| 11.113 (0.438") +0.038/+0.064 (mm) | 15.875 +0.051/+0.076 | 9.525 +/-0.127 | BP0111-0159-0095-BSTH2 |
| 11.113 (0.438") +0.013/+0.038 (mm) | 15.875 +0.025/+0.051 | 11.113 +/-0.127 | BP0111-0159-0111-BSLT |
| 11.113 (0.438") +0.013/+0.038 (mm) | 15.875 +0.025/+0.051 | 12.700 +/-0.127 | BP0111-0159-0127-BSLT |
| 11.113 (0.438") +0.013/+0.038 (mm) | 15.875 +0.051/+0.076 | 12.700 +/-0.127 | BP0111-0159-0127-BSLH |



Stocked or Short Delivery



Usually Available Short Delivery



Long delivery or not in current production

* Large Minimum Quantities

** Available only while stock lasts

Bushes - Plain

| Nominal ID (d) mm (inches) | Nominal OD (D) mm | Length (S) mm | Part Number |
|---------------------------------------|-------------------------|--------------------|-------------------------------|
| 11.113 (0.438") +0.025/+0.051 (mm) | 15.875 +0.051/+0.076 | 12.700 +/-0.127 | BP0111-0159-0127-BSTH1 |
| 11.113 (0.438") +0.038/+0.064 (mm) | 15.875 +0.051/+0.076 | 12.700 +/-0.127 | BP0111-0159-0127-BSTH2 |
| 11.113 (0.438") +0.013/+0.038 (mm) | 15.875 +0.025/+0.051 | 15.875 | BP0111-0159-0159-BSLT |
| 11.113 (0.438") +0.013/+0.038 (mm) | 15.875 +0.051/+0.076 | 15.875 +/-0.127 | BP0111-0159-0159-BSLH |
| 11.113 (0.438") +0.025/+0.051 (mm) | 15.875 +0.051/+0.076 | 15.875 +/-0.127 | BP0111-0159-0159-BSTH1 |
| 11.113 (0.438") +0.038/+0.064 (mm) | 15.875 +0.051/+0.076 | 15.875 +/-0.127 | BP0111-0159-0159-BSTH2 |
| 11.113 (0.438") +0.013/+0.038 (mm) | 15.875 +0.025/+0.051 | 19.050 | BP0111-0159-0191-BSLT |
| 11.113 (0.438") +0.013/+0.038 (mm) | 15.875 +0.051/+0.076 | 19.050 +/-0.127 | BP0111-0159-0191-BSLH |
| 11.113 (0.438") +0.025/+0.051 (mm) | 15.875 +0.051/+0.076 | 19.050 +/-0.127 | BP0111-0159-0191-BSTH1 |
| 11.113 (0.438") +0.038/+0.064 (mm) | 15.875 +0.051/+0.076 | 19.050 +/-0.127 | BP0111-0159-0191-BSTH2 |
| 11.113 (0.438") +0.013/+0.038 (mm) | 15.875 +0.051/+0.076 | 22.225 +/-0.127 | BP0111-0159-0222-BSLH |
| 11.113 (0.438") +0.025/+0.051 (mm) | 15.875 +0.051/+0.076 | 22.225 +/-0.127 | BP0111-0159-0222-BSTH1 |
| 11.113 (0.438") +0.038/+0.064 (mm) | 15.875 +0.051/+0.076 | 22.225 +/-0.127 | BP0111-0159-0222-BSTH2 |
| 11.113 (0.438") +0.013/+0.038 (mm) | 15.875 +0.025/+0.051 | 25.400 | BP0111-0159-0254-BSLT |
| 11.113 (0.438") +0.013/+0.038 (mm) | 15.875 +0.051/+0.076 | 25.400 +/-0.127 | BP0111-0159-0254-BSLH |
| 11.113 (0.438") +0.025/+0.051 (mm) | 15.875 +0.051/+0.076 | 25.400 +/-0.127 | BP0111-0159-0254-BSTH1 |
| 11.113 (0.438") +0.038/+0.064 (mm) | 15.875 +0.051/+0.076 | 25.400 +/-0.127 | BP0111-0159-0254-BSTH2 |
| 11.113 (0.438") +0.013/+0.038 (mm) | 15.875 +0.025/+0.051 | 31.750 | BP0111-0159-0318-BSLT |
| 11.113 (0.438") +0.013/+0.038 (mm) | 15.875 +0.051/+0.076 | 31.750 +/-0.127 | BP0111-0159-0318-BSLH |
| 11.113 (0.438") +0.025/+0.051 (mm) | 15.875 +0.051/+0.076 | 31.750 +/-0.127 | BP0111-0159-0318-BSTH1 |
| 11.113 (0.438") +0.038/+0.064 (mm) | 15.875 +0.051/+0.076 | 31.750 +/-0.127 | BP0111-0159-0318-BSTH2 |
| 11.113 (0.438") +0.013/+0.038 (mm) | 15.875 +0.025/+0.051 | 38.100 | BP0111-0159-0381-BSLT |
| 11.113 (0.438") +0.025/+0.051 (mm) | 15.875 +0.051/+0.076 | 38.100 +/-0.127 | BP0111-0159-0381-BSTH1 |
| 11.113 (0.438") +0.038/+0.064 (mm) | 15.875 +0.051/+0.076 | 38.100 +/-0.127 | BP0111-0159-0381-BSTH2 |
| 11.113 (0.438") +0.013/+0.038 (mm) | 17.463 +0.038/+0.064 | 12.700 +/-0.127 | BP0111-0175-0127-BSLT |
| 11.113 (0.438") +0.025/+0.051 (mm) | 17.463 +0.051/+0.076 | 12.700 +/-0.127 | BP0111-0175-0127-BSTH |
| 11.113 (0.438") +0.013/+0.038 (mm) | 17.463 +0.038/+0.064 | 25.400 +/-0.127 | BP0111-0175-0254-BSLT |
| 11.113 (0.438") +0.025/+0.051 (mm) | 17.463 +0.051/+0.076 | 25.400 +/-0.127 | BP0111-0175-0254-BSTH |
| 11.113 (0.438") +0.013/+0.038 (mm) | 17.463 +0.038/+0.064 | 38.100 +/-0.127 | BP0111-0175-0381-BSLT |
| 11.113 (0.438") +0.025/+0.051 (mm) | 17.463 +0.051/+0.076 | 38.100 +/-0.127 | BP0111-0175-0381-BSTH |
| 12.000 (0.472") +0.005/+0.030 (mm) | 14.000 +0.025/+0.051 | 9.000 +/-0.120 | BP0120-0140-0090-BSLT |
| 12.000 (0.472") +0.005/+0.030 (mm) | 14.000 +0.025/+0.051 | 12.000 +/-0.120 | BP0120-0140-0120-BSLT |
| 12.000 (0.472") +0.005/+0.030 (mm) | 14.000 +0.025/+0.051 | 14.000 +/-0.120 | BP0120-0140-0140-BSLT |
| 12.000 (0.472") +0.005/+0.030 (mm) | 14.000 +0.025/+0.051 | 16.000 +/-0.120 | BP0120-0140-0160-BSLT |

Stocked or Short Delivery
 Usually Available Short Delivery
 Long delivery or not in current production

* Large Minimum Quantities

** Available only while stock lasts

Bushes - Plain

| Nominal ID (d) mm (inches) | Nominal OD (D) mm | Length (S) mm | Part Number |
|---------------------------------------|-------------------------|---------------------|------------------------------|
| 12.000 (0.472") +0.005/+0.030 (mm) | 15.000 +0.025/+0.051 | 8.000 +/-0.120 | BP0120-0150-0080-BSLT |
| 12.000 (0.472") +0.005/+0.030 (mm) | 15.000 +0.025/+0.051 | 12.000 +/-0.120 | BP0120-0150-0120-BSLT |
| 12.000 (0.472") +0.005/+0.030 (mm) | 15.000 +0.025/+0.051 | 16.000 +/-0.120 | BP0120-0150-0160-BSLT |
| 12.000 (0.472") +0.005/+0.030 (mm) | 15.000 +0.025/+0.051 | 18.000 +/-0.120 | BP0120-0150-0180-BSLT |
| 12.000 (0.472") +0.005/+0.030 (mm) | 15.000 +0.025/+0.051 | 20.000 +/-0.120 | BP0120-0150-0200-BSLT |
| 12.000 (0.472") +0.005/+0.030 (mm) | 15.000 +0.025/+0.051 | 25.000 +/-0.120 | BP0120-0150-0250-BSLT |
| 12.000 (0.472") +0.005/+0.030 (mm) | 16.000 +0.025/+0.051 | 8.000 +/-0.127 | BP0120-0160-0080-BSLT |
| 12.000 (0.472") +0.005/+0.030 (mm) | 16.000 +0.025/+0.051 | 12.000 +/-0.127 | BP0120-0160-0120-BSLT |
| 12.000 (0.472") +0.005/+0.030 (mm) | 16.000 +0.025/+0.051 | 15.000 +/-0.120 | BP0120-0160-0150-BSLT |
| 12.000 (0.472") +0.005/+0.030 (mm) | 16.000 +0.025/+0.051 | 16.000 +/-0.127 | BP0120-0160-0160-BSLT |
| 12.000 (0.472") +0.015/+0.041 (mm) | 16.000 +0.025/+0.051 | 20.000 +0/-0.200 | BP0120-0160-0200-BSLT |
| 12.000 (0.472") +0.005/+0.030 (mm) | 16.000 +0.025/+0.051 | 25.000 +/-0.127 | BP0120-0160-0250-BSLT |
| 12.000 (0.472") +0.005/+0.030 (mm) | 16.000 +0.025/+0.051 | 27.000 +/-0.120 | BP0120-0160-0270-BSLT |
| 12.000 (0.472") +0.005/+0.030 (mm) | 17.000 +0.025/+0.051 | 10.000 +/-0.120 | BP0120-0170-0100-BSLT |
| 12.000 (0.472") +0.005/+0.030 (mm) | 17.000 +0.025/+0.051 | 12.000 +/-0.120 | BP0120-0170-0120-BSLT |
| 12.000 (0.472") +0.005/+0.030 (mm) | 17.000 +0.025/+0.051 | 16.000 +/-0.120 | BP0120-0170-0160-BSLT |
| 12.000 (0.472") +0.005/+0.030 (mm) | 17.000 +0.025/+0.051 | 18.000 +/-0.120 | BP0120-0170-0180-BSLT |
| 12.000 (0.472") +0.005/+0.030 (mm) | 17.000 +0.025/+0.051 | 20.000 +/-0.120 | BP0120-0170-0200-BSLT |
| 12.000 (0.472") +0.005/+0.030 (mm) | 17.000 +0.025/+0.051 | 25.000 +/-0.120 | BP0120-0170-0250-BSLT |
| 12.000 (0.472") +0.005/+0.030 (mm) | 18.000 +0.025/+0.051 | 8.000 +/-0.127 | BP0120-0180-0080-BSLT |
| 12.000 (0.472") +0.005/+0.030 (mm) | 18.000 +0.025/+0.051 | 10.000 +/-0.127 | BP0120-0180-0100-BSLT |
| 12.000 (0.472") +0.005/+0.030 (mm) | 18.000 +0.025/+0.051 | 12.000 +/-0.127 | BP0120-0180-0120-BSLT |
| 12.000 (0.472") +0.005/+0.030 (mm) | 18.000 +0.025/+0.051 | 16.000 +0/-0.200 | BP0120-0180-0160-BSLT |
| 12.000 (0.472") +0.005/+0.030 (mm) | 18.000 +0.025/+0.051 | 18.000 +/-0.120 | BP0120-0180-0180-BSLT |
| 12.000 (0.472") +0.005/+0.030 (mm) | 18.000 +0.025/+0.051 | 20.000 +/-0.127 | BP0120-0180-0200-BSLT |
| 12.000 (0.472") +0.005/+0.030 (mm) | 18.000 +0.025/+0.051 | 25.000 +0/-0.200 | BP0120-0180-0250-BSLT |
| 12.000 (0.472") +0.005/+0.030 (mm) | 20.000 +0.036/+0.061 | 8.000 +0/-0.170 | BP0120-0200-0080-BSLT |
| 12.700 (0.500") +0.013/+0.038 (mm) | 15.875 +0.051/+0.076 | 7.938 +/-0.127 | BP0127-0159-0079-BSLH |
| 12.700 (0.500") +0.025/+0.051 (mm) | 15.875 +0.051/+0.076 | 7.938 +/-0.127 | BP0127-0159-0079-BSTH |
| 12.700 (0.500") +0.025/+0.051 (mm) | 15.875 +0.051/+0.076 | 9.398 +/-0.127 | BP0127-0159-0094-BSTH |
| 12.700 (0.500") +0.013/+0.038 (mm) | 15.875 +0.051/+0.076 | 9.525 | BP0127-0159-0095-BSLH |
| 12.700 (0.500") +0.025/+0.051 (mm) | 15.875 +0.051/+0.076 | 9.525 +/-0.127 | BP0127-0159-0095-BSTH |
| 12.700 (0.500") +0.051/+0.076 (mm) | 15.875 +0.051/+0.076 | 10.617 +0/-0.102 | BP0127-0159-0106-BSHH |
| 12.700 (0.500") +0.013/+0.038 (mm) | 15.875 +0.051/+0.076 | 11.100 | BP0127-0159-0111-BSLH |



Stocked or Short Delivery



Usually Available Short Delivery



Long delivery or not in current production

* Large Minimum Quantities

** Available only while stock lasts

Bushes - Plain

| Nominal ID (d) mm (inches) | Nominal OD (D) mm | Length (S) mm | Part Number |
|---------------------------------------|-------------------------|--------------------|-------------------------------|
| 12.700 (0.500") +0.051/+0.076 (mm) | 15.875 +0.051/+0.076 | 11.100 +/-0.127 | BP0127-0159-0111-BSHH |
| 12.700 (0.500") +0.025/+0.051 (mm) | 15.875 +0.051/+0.076 | 11.113 +/-0.127 | BP0127-0159-0111-BSTH |
| 12.700 (0.500") +0.013/+0.038 (mm) | 15.875 +0.051/+0.076 | 12.700 +/-0.127 | BP0127-0159-0127-BSLH |
| 12.700 (0.500") +0.025/+0.051 (mm) | 15.875 +0.051/+0.076 | 12.700 +/-0.127 | BP0127-0159-0127-BSTH1 |
| 12.700 (0.500") +0.038/+0.064 (mm) | 15.875 +0.076/+0.102 | 12.700 +/-0.127 | BP0127-0159-0127-BSTH2 |
| 12.700 (0.500") +0.076/+0.102 (mm) | 15.875 +0.038/+0.064 | 12.700 +/-0.127 | BP0127-0159-0127-BSHT |
| 12.700 (0.500") +0.013/+0.038 (mm) | 15.875 +0.051/+0.076 | 14.288 +/-0.127 | BP0127-0159-0143-BSLH |
| 12.700 (0.500") +0.025/+0.051 (mm) | 15.875 +0.051/+0.076 | 14.288 +/-0.127 | BP0127-0159-0143-BSTH |
| 12.700 (0.500") +0.051/+0.076 (mm) | 15.875 +0.051/+0.076 | 15.062 +/-0.127 | BP0127-0159-0151-BSHH |
| 12.700 (0.500") +0.013/+0.038 (mm) | 15.875 +0.051/+0.076 | 15.875 +/-0.127 | BP0127-0159-0159-BSLH |
| 12.700 (0.500") +0.025/+0.051 (mm) | 15.875 +0.051/+0.076 | 15.875 +/-0.127 | BP0127-0159-0159-BSTH1 |
| 12.700 (0.500") +0.038/+0.064 (mm) | 15.875 +0.076/+0.102 | 15.875 +/-0.127 | BP0127-0159-0159-BSTH2 |
| 12.700 (0.500") +0.013/+0.038 (mm) | 15.875 +0.051/+0.076 | 17.463 +/-0.127 | BP0127-0159-0175-BSLH |
| 12.700 (0.500") +0.025/+0.051 (mm) | 15.875 +0.051/+0.076 | 17.463 +/-0.127 | BP0127-0159-0175-BSTH |
| 12.700 (0.500") +0.013/+0.038 (mm) | 15.875 +0.051/+0.076 | 19.050 +/-0.127 | BP0127-0159-0191-BSLH |
| 12.700 (0.500") +0.025/+0.051 (mm) | 15.875 +0.051/+0.076 | 19.050 +/-0.127 | BP0127-0159-0191-BSTH1 |
| 12.700 (0.500") +0.038/+0.064 (mm) | 15.875 +0.076/+0.102 | 19.050 +/-0.127 | BP0127-0159-0191-BSTH2 |
| 12.700 (0.500") +0.013/+0.038 (mm) | 15.875 +0.051/+0.076 | 22.225 +/-0.127 | BP0127-0159-0222-BSLH |
| 12.700 (0.500") +0.025/+0.051 (mm) | 15.875 +0.051/+0.076 | 22.225 +/-0.127 | BP0127-0159-0222-BSTH |
| 12.700 (0.500") +0.013/+0.038 (mm) | 15.875 +0.051/+0.076 | 25.400 +/-0.127 | BP0127-0159-0254-BSLH |
| 12.700 (0.500") +0.025/+0.051 (mm) | 15.875 +0.051/+0.076 | 25.400 +/-0.127 | BP0127-0159-0254-BSTH1 |
| 12.700 (0.500") +0.038/+0.064 (mm) | 15.875 +0.076/+0.102 | 25.400 +/-0.127 | BP0127-0159-0254-BSTH2 |
| 12.700 (0.500") +0.076/+0.102 (mm) | 15.875 +0.038/+0.064 | 25.400 +/-0.127 | BP0127-0159-0254-BSHT |
| 12.700 (0.500") +0.051/+0.076 (mm) | 15.875 +0.051/+0.076 | 26.162 +/-0.127 | BP0127-0159-0262-BSHH |
| 12.700 (0.500") +0.025/+0.051 (mm) | 15.875 +0.051/+0.076 | 28.575 +/-0.127 | BP0127-0159-0286-BSTH |
| 12.700 (0.500") +0.013/+0.038 (mm) | 15.875 +0.051/+0.076 | 31.750 +/-0.127 | BP0127-0159-0318-BSLH |
| 12.700 (0.500") +0.025/+0.051 (mm) | 15.875 +0.051/+0.076 | 31.750 +/-0.127 | BP0127-0159-0318-BSTH1 |
| 12.700 (0.500") +0.038/+0.064 (mm) | 15.875 +0.076/+0.102 | 31.750 +/-0.127 | BP0127-0159-0318-BSTH2 |
| 12.700 (0.500") +0.013/+0.038 (mm) | 15.875 +0.051/+0.076 | 38.100 +/-0.127 | BP0127-0159-0381-BSLH |
| 12.700 (0.500") +0.025/+0.051 (mm) | 15.875 +0.051/+0.076 | 38.100 +/-0.127 | BP0127-0159-0381-BSTH |
| 12.700 (0.500") +0.076/+0.102 (mm) | 17.463 +0.038/+0.064 | 6.350 +/-0.127 | BP0127-0175-0064-BSHT |
| 12.700 (0.500") +0.013/+0.038 (mm) | 17.463 +0.038/+0.064 | 9.525 +/-0.127 | BP0127-0175-0095-BSLT2 |
| 12.700 (0.500") +0.025/+0.051 (mm) | 17.463 +0.051/+0.076 | 9.525 +/-0.127 | BP0127-0175-0095-BSTH |
| 12.700 (0.500") +0.038/+0.064 (mm) | 17.463 +0.013/+0.038 | 9.525 +/-0.127 | BP0127-0175-0095-BSTL |



Stocked or Short Delivery



Usually Available Short Delivery



Long delivery or not in current production

* Large Minimum Quantities

** Available only while stock lasts

Bushes - Plain

| Nominal ID (d) mm (inches) | Nominal OD (D) mm | Length (S) mm | Part Number |
|---------------------------------------|-------------------------|--------------------|-------------------------------|
| 12.700 (0.500") +0.013/+0.038 (mm) | 17.463 +0.038/+0.064 | 12.700 +/-0.127 | BP0127-0175-0127-BSLT |
| 12.700 (0.500") +0.025/+0.051 (mm) | 17.463 +0.038/+0.064 | 12.700 +/-0.127 | BP0127-0175-0127-BSTT |
| 12.700 (0.500") +0.025/+0.051 (mm) | 17.463 +0.051/+0.076 | 12.700 +/-0.127 | BP0127-0175-0127-BSTH |
| 12.700 (0.500") +0.051/+0.076 (mm) | 17.463 +0.038/+0.064 | 12.700 +/-0.127 | BP0127-0175-0127-BSHT1 |
| 12.700 (0.500") +0.076/+0.102 (mm) | 17.463 +0.038/+0.064 | 12.700 +/-0.127 | BP0127-0175-0127-BSHT2 |
| 12.700 (0.500") +0.013/+0.038 (mm) | 17.463 +0.038/+0.064 | 14.288 +/-0.127 | BP0127-0175-0143-BSLT |
| 12.700 (0.500") +0.076/+0.102 (mm) | 17.463 +0.038/+0.064 | 14.288 +/-0.127 | BP0127-0175-0143-BSHT |
| 12.700 (0.500") +0.013/+0.038 (mm) | 17.463 +0.038/+0.064 | 15.875 +/-0.127 | BP0127-0175-0159-BSLT |
| 12.700 (0.500") +0.025/+0.051 (mm) | 17.463 +0.038/+0.064 | 15.875 +/-0.127 | BP0127-0175-0159-BSTT |
| 12.700 (0.500") +0.025/+0.051 (mm) | 17.463 +0.051/+0.076 | 15.875 +/-0.127 | BP0127-0175-0159-BSTH |
| 12.700 (0.500") +0.051/+0.076 (mm) | 17.463 +0.038/+0.064 | 15.875 +/-0.127 | BP0127-0175-0159-BSHT1 |
| 12.700 (0.500") +0.076/+0.102 (mm) | 17.463 +0.038/+0.064 | 15.875 +/-0.127 | BP0127-0175-0159-BSHT2 |
| 12.700 (0.500") +0.013/+0.038 (mm) | 17.463 +0.038/+0.064 | 19.050 +/-0.127 | BP0127-0175-0191-BSLT |
| 12.700 (0.500") +0.025/+0.051 (mm) | 17.463 +0.038/+0.064 | 19.050 +/-0.127 | BP0127-0175-0191-BSTT |
| 12.700 (0.500") +0.025/+0.051 (mm) | 17.463 +0.051/+0.076 | 19.050 +/-0.127 | BP0127-0175-0191-BSTH |
| 12.700 (0.500") +0.038/+0.064 (mm) | 17.463 +0.013/+0.038 | 19.050 +/-0.127 | BP0127-0175-0191-BSTL |
| 12.700 (0.500") +0.051/+0.076 (mm) | 17.463 +0.038/+0.064 | 19.050 +/-0.127 | BP0127-0175-0191-BSHT1 |
| 12.700 (0.500") +0.076/+0.102 (mm) | 17.463 +0.038/+0.064 | 19.050 +/-0.127 | BP0127-0175-0191-BSHT2 |
| 12.700 (0.500") +0.013/+0.038 (mm) | 17.463 +0.038/+0.064 | 22.225 +/-0.127 | BP0127-0175-0222-BSLT1 |
| 12.700 (0.500") +0.025/+0.051 (mm) | 17.463 +0.038/+0.064 | 22.225 +/-0.127 | BP0127-0175-0222-BSTT |
| 12.700 (0.500") +0.025/+0.051 (mm) | 17.463 +0.051/+0.076 | 22.225 +/-0.127 | BP0127-0175-0222-BSTH |
| 12.700 (0.500") +0.051/+0.076 (mm) | 17.463 +0.038/+0.064 | 22.225 +/-0.127 | BP0127-0175-0222-BSHT1 |
| 12.700 (0.500") +0.076/+0.102 (mm) | 17.463 +0.038/+0.064 | 22.225 +/-0.127 | BP0127-0175-0222-BSHT2 |
| 12.700 (0.500") +0.013/+0.038 (mm) | 17.463 +0.038/+0.064 | 25.400 +/-0.127 | BP0127-0175-0254-BSLT |
| 12.700 (0.500") +0.025/+0.051 (mm) | 17.463 +0.038/+0.064 | 25.400 +/-0.127 | BP0127-0175-0254-BSTT |
| 12.700 (0.500") +0.025/+0.051 (mm) | 17.463 +0.051/+0.076 | 25.400 +/-0.127 | BP0127-0175-0254-BSTH |
| 12.700 (0.500") +0.051/+0.076 (mm) | 17.463 +0.038/+0.064 | 25.400 +/-0.127 | BP0127-0175-0254-BSHT1 |
| 12.700 (0.500") +0.076/+0.102 (mm) | 17.463 +0.038/+0.064 | 25.400 +/-0.127 | BP0127-0175-0254-BSHT2 |
| 12.700 (0.500") +0.013/+0.038 (mm) | 17.463 +0.038/+0.064 | 28.575 +/-0.127 | BP0127-0175-0286-BSLT |
| 12.700 (0.500") +0.025/+0.051 (mm) | 17.463 +0.038/+0.064 | 28.575 +/-0.127 | BP0127-0175-0286-BSTT |
| 12.700 (0.500") +0.025/+0.051 (mm) | 17.463 +0.051/+0.076 | 28.575 +/-0.397 | BP0127-0175-0286-BSTH |
| 12.700 (0.500") +0.051/+0.076 (mm) | 17.463 +0.038/+0.064 | 28.575 +/-0.127 | BP0127-0175-0286-BSHT1 |
| 12.700 (0.500") +0.076/+0.102 (mm) | 17.463 +0.038/+0.064 | 28.575 +/-0.127 | BP0127-0175-0286-BSHT2 |
| 12.700 (0.500") +0.013/+0.038 (mm) | 17.463 +0.038/+0.064 | 31.750 +/-0.127 | BP0127-0175-0318-BSLT |



Stocked or Short Delivery



Usually Available Short Delivery



Long delivery or not in current production

* Large Minimum Quantities

** Available only while stock lasts

Bushes - Plain

| Nominal ID (d) mm (inches) | Nominal OD (D) mm | Length (S) mm | Part Number |
|-------------------------------|----------------------|---------------|-------------------------------|
| 12.700 (0.500") | 17.463 | 31.750 | BP0127-0175-0318-BSTT |
| +0.025/+0.051 (mm) | +0.038/+0.064 | +/-0.127 | |
| 12.700 (0.500") | 17.463 | 31.750 | BP0127-0175-0318-BSTH |
| +0.025/+0.051 (mm) | +0.051/+0.076 | +/-0.127 | |
| 12.700 (0.500") | 17.463 | 31.750 | BP0127-0175-0318-BSTL |
| +0.038/+0.064 (mm) | +0.013/+0.038 | +/-0.127 | |
| 12.700 (0.500") | 17.463 | 31.750 | BP0127-0175-0318-BSHT |
| +0.051/+0.076 (mm) | +0.038/+0.064 | +/-0.127 | |
| 12.700 (0.500") | 17.463 | 34.925 | BP0127-0175-0349-BSHT |
| +0.076/+0.102 (mm) | +0.038/+0.064 | +/-0.127 | |
| 12.700 (0.500") | 17.463 | 38.100 | BP0127-0175-0381-BSLT |
| +0.013/+0.038 (mm) | +0.038/+0.064 | | |
| 12.700 (0.500") | 17.463 | 38.100 | BP0127-0175-0381-BSTT |
| +0.025/+0.051 (mm) | +0.038/+0.064 | +/-0.127 | |
| 12.700 (0.500") | 17.463 | 38.100 | BP0127-0175-0381-BSTH |
| +0.025/+0.051 (mm) | +0.051/+0.076 | +/-0.127 | |
| 12.700 (0.500") | 17.463 | 38.100 | BP0127-0175-0381-BSHT |
| +0.051/+0.076 (mm) | +0.038/+0.064 | +/-0.127 | |
| 12.700 (0.500") | 19.050 | 6.350 | BP0127-0191-0064-BSHH |
| +0.051/+0.076 (mm) | +0.051/+0.076 | +/-0.127 | |
| 12.700 (0.500") | 19.050 | 9.525 | BP0127-0191-0095-BSTH |
| +0.025/+0.051 (mm) | +0.051/+0.076 | +/-0.127 | |
| 12.700 (0.500") | 19.050 | 9.525 | BP0127-0191-0095-BSHH |
| +0.051/+0.076 (mm) | +0.051/+0.076 | +/-0.127 | |
| 12.700 (0.500") | 19.050 | 11.100 | BP0127-0191-0111-BSHH |
| +0.051/+0.076 (mm) | +0.064/+0.089 | +0/-0.203 | |
| 12.700 (0.500") | 19.050 | 12.700 | BP0127-0191-0127-BSUT |
| +/-0.013 (mm) | +0.025/+0.051 | +/-0.127 | |
| 12.700 (0.500") | 19.050 | 12.700 | BP0127-0191-0127-BSLT |
| +0.013/+0.038 (mm) | +0.025/+0.051 | +/-0.127 | |
| 12.700 (0.500") | 19.050 | 12.700 | BP0127-0191-0127-BSTH1 |
| +0.025/+0.051 (mm) | +0.051/+0.076 | +/-0.127 | |
| 12.700 (0.500") | 19.050 | 12.700 | BP0127-0191-0127-BSTH2 |
| +0.038/+0.064 (mm) | +0.051/+0.076 | +/-0.127 | |
| 12.700 (0.500") | 19.050 | 12.700 | BP0127-0191-0127-BSHH |
| +0.051/+0.076 (mm) | +0.051/+0.076 | +/-0.127 | |
| 12.700 (0.500") | 19.050 | 14.288 | BP0127-0191-0143-BSLT |
| +0.013/+0.038 (mm) | +0.025/+0.051 | +/-0.127 | |
| 12.700 (0.500") | 19.050 | 15.875 | BP0127-0191-0159-BSTH1 |
| +0.025/+0.051 (mm) | +0.051/+0.076 | +/-0.127 | |
| 12.700 (0.500") | 19.050 | 15.875 | BP0127-0191-0159-BSTH2 |
| +0.038/+0.064 (mm) | +0.051/+0.076 | +/-0.127 | |
| 12.700 (0.500") | 19.050 | 15.875 | BP0127-0191-0159-BSHH |
| +0.051/+0.076 (mm) | +0.051/+0.076 | +/-0.127 | |
| 12.700 (0.500") | 19.050 | 19.050 | BP0127-0191-0191-BSUT |
| +/-0.013 (mm) | +0.025/+0.051 | +/-0.127 | |
| 12.700 (0.500") | 19.050 | 19.050 | BP0127-0191-0191-BSLT |
| +0.013/+0.038 (mm) | +0.025/+0.051 | +/-0.127 | |
| 12.700 (0.500") | 19.050 | 19.050 | BP0127-0191-0191-BSTH1 |
| +0.025/+0.051 (mm) | +0.051/+0.076 | +/-0.127 | |
| 12.700 (0.500") | 19.050 | 19.050 | BP0127-0191-0191-BSTH2 |
| +0.038/+0.064 (mm) | +0.051/+0.076 | +/-0.127 | |
| 12.700 (0.500") | 19.050 | 19.050 | BP0127-0191-0191-BSHH |
| +0.051/+0.076 (mm) | +0.051/+0.076 | +/-0.127 | |
| 12.700 (0.500") | 19.050 | 22.225 | BP0127-0191-0222-BSTH1 |
| +0.025/+0.051 (mm) | +0.051/+0.076 | +/-0.127 | |
| 12.700 (0.500") | 19.050 | 22.225 | BP0127-0191-0222-BSTH2 |
| +0.038/+0.064 (mm) | +0.051/+0.076 | +/-0.127 | |
| 12.700 (0.500") | 19.050 | 22.225 | BP0127-0191-0222-BSHH |
| +0.051/+0.076 (mm) | +0.051/+0.076 | +/-0.127 | |
| 12.700 (0.500") | 19.050 | 25.400 | BP0127-0191-0254-BSUT |
| +/-0.013 (mm) | +0.025/+0.051 | +/-0.127 | |
| 12.700 (0.500") | 19.050 | 25.400 | BP0127-0191-0254-BSLT |
| +0.013/+0.038 (mm) | +0.025/+0.051 | +/-0.127 | |
| 12.700 (0.500") | 19.050 | 25.400 | BP0127-0191-0254-BSTH1 |
| +0.025/+0.051 (mm) | +0.051/+0.076 | +/-0.127 | |
| 12.700 (0.500") | 19.050 | 25.400 | BP0127-0191-0254-BSTH2 |
| +0.038/+0.064 (mm) | +0.051/+0.076 | +/-0.127 | |

Stocked or Short Delivery
 Usually Available Short Delivery
 Long delivery or not in current production

* Large Minimum Quantities

** Available only while stock lasts

Bushes - Plain

| Nominal ID (d) mm (inches) | Nominal OD (D) mm | Length (S) mm | Part Number |
|---------------------------------------|-------------------------|--------------------|-------------------------------|
| 12.700 (0.500") +0.051/+0.076 (mm) | 19.050 +0.051/+0.076 | 25.400 +/-0.127 | BP0127-0191-0254-BSHH |
| 12.700 (0.500") +/-0.013 (mm) | 19.050 +0.025/+0.051 | 28.575 +/-0.127 | BP0127-0191-0286-BSUT |
| 12.700 (0.500") +0.025/+0.051 (mm) | 19.050 +0.051/+0.076 | 28.575 +/-0.397 | BP0127-0191-0286-BSTH |
| 12.700 (0.500") +0.051/+0.076 (mm) | 19.050 +0.051/+0.076 | 28.575 +/-0.127 | BP0127-0191-0286-BSHH |
| 12.700 (0.500") +/-0.013 (mm) | 19.050 +0.025/+0.051 | 31.750 +/-0.127 | BP0127-0191-0318-BSUT |
| 12.700 (0.500") +0.025/+0.051 (mm) | 19.050 +0.051/+0.076 | 31.750 +/-0.127 | BP0127-0191-0318-BSTH1 |
| 12.700 (0.500") +0.038/+0.064 (mm) | 19.050 +0.051/+0.076 | 31.750 +/-0.127 | BP0127-0191-0318-BSTH2 |
| 12.700 (0.500") +0.051/+0.076 (mm) | 19.050 +0.051/+0.076 | 31.750 +/-0.127 | BP0127-0191-0318-BSHH |
| 12.700 (0.500") +0.013/+0.038 (mm) | 19.050 +0.025/+0.051 | 38.100 +/-0.127 | BP0127-0191-0381-BSLT |
| 12.700 (0.500") +0.025/+0.051 (mm) | 19.050 +0.051/+0.076 | 38.100 +/-0.127 | BP0127-0191-0381-BSTH1 |
| 12.700 (0.500") +0.038/+0.064 (mm) | 19.050 +0.051/+0.076 | 38.100 +/-0.127 | BP0127-0191-0381-BSTH2 |
| 12.700 (0.500") +0.051/+0.076 (mm) | 19.050 +0.051/+0.076 | 38.100 +/-0.127 | BP0127-0191-0381-BSHH |
| 12.700 (0.500") +0.025/+0.051 (mm) | 19.050 +0.051/+0.076 | 44.450 +/-0.190 | BP0127-0191-0445-BSTH1 |
| 12.700 (0.500") +0.038/+0.064 (mm) | 19.050 +0.051/+0.076 | 44.450 +/-0.190 | BP0127-0191-0445-BSTH2 |
| 12.700 (0.500") +0.051/+0.076 (mm) | 19.050 +0.051/+0.076 | 44.450 +/-0.190 | BP0127-0191-0445-BSHH |
| 12.700 (0.500") +0.025/+0.051 (mm) | 19.050 +0.051/+0.076 | 50.800 +/-0.190 | BP0127-0191-0508-BSTH |
| 12.700 (0.500") +0.051/+0.076 (mm) | 19.050 +0.051/+0.076 | 50.800 +/-0.190 | BP0127-0191-0508-BSHH |
| 12.700 (0.500") +0.025/+0.051 (mm) | 20.638 +0.038/+0.064 | 12.700 +/-0.127 | BP0127-0206-0127-BSTT |
| 12.700 (0.500") +0.025/+0.051 (mm) | 20.638 +0.076/+0.102 | 12.700 +/-0.127 | BP0127-0206-0127-BSTH |
| 12.700 (0.500") +0.051/+0.076 (mm) | 20.638 +0.038/+0.064 | 12.700 +/-0.127 | BP0127-0206-0127-BSHT |
| 12.700 (0.500") +0.000/+0.025 (mm) | 20.638 +0.038/+0.064 | 19.050 +/-0.127 | BP0127-0206-0191-BSLT |
| 12.700 (0.500") +0.025/+0.051 (mm) | 20.638 +0.038/+0.064 | 19.050 +/-0.127 | BP0127-0206-0191-BSTT |
| 12.700 (0.500") +0.025/+0.051 (mm) | 20.638 +0.076/+0.102 | 19.050 +/-0.127 | BP0127-0206-0191-BSTH |
| 12.700 (0.500") +0.051/+0.076 (mm) | 20.638 +0.038/+0.064 | 19.050 +/-0.127 | BP0127-0206-0191-BSHT |
| 12.700 (0.500") +0.000/+0.025 (mm) | 20.638 +0.038/+0.064 | 25.400 +/-0.127 | BP0127-0206-0254-BSLT |
| 12.700 (0.500") +0.025/+0.051 (mm) | 20.638 +0.038/+0.064 | 25.400 +/-0.127 | BP0127-0206-0254-BSTT |
| 12.700 (0.500") +0.025/+0.051 (mm) | 20.638 +0.076/+0.102 | 25.400 +/-0.127 | BP0127-0206-0254-BSTH |
| 12.700 (0.500") +0.051/+0.076 (mm) | 20.638 +0.038/+0.064 | 25.400 +/-0.127 | BP0127-0206-0254-BSHT |
| 12.700 (0.500") +0.000/+0.025 (mm) | 20.638 +0.038/+0.064 | 38.100 +/-0.127 | BP0127-0206-0381-BSLT |
| 12.700 (0.500") +0.025/+0.051 (mm) | 20.638 +0.038/+0.064 | 38.100 +/-0.127 | BP0127-0206-0381-BSTT |
| 12.700 (0.500") +0.025/+0.051 (mm) | 20.638 +0.076/+0.102 | 38.100 +/-0.127 | BP0127-0206-0381-BSTH |
| 12.700 (0.500") +0.051/+0.076 (mm) | 20.638 +0.038/+0.064 | 38.100 +/-0.127 | BP0127-0206-0381-BSHT |
| 12.700 (0.500") +0.025/+0.051 (mm) | 22.225 +0.051/+0.076 | 12.700 +/-0.127 | BP0127-0222-0127-BSTH1 |
| 12.700 (0.500") +0.025/+0.051 (mm) | 22.225 +0.076/+0.102 | 12.700 +/-0.127 | BP0127-0222-0127-BSTH2 |

Stocked or Short Delivery
 Usually Available Short Delivery
 Long delivery or not in current production

* Large Minimum Quantities

** Available only while stock lasts

Bushes - Plain

| Nominal ID (d) mm (inches) | Nominal OD (D) mm | Length (S) mm | Part Number |
|---------------------------------------|-------------------------|--------------------|-------------------------------|
| 12.700 (0.500") +0.051/+0.076 (mm) | 22.225 +0.051/+0.076 | 12.700 +/-0.127 | BP0127-0222-0127-BSHH1 |
| 12.700 (0.500") +0.051/+0.076 (mm) | 22.225 +0.076/+0.102 | 12.700 +/-0.127 | BP0127-0222-0127-BSHH2 |
| 12.700 (0.500") +0.025/+0.051 (mm) | 22.225 +0.051/+0.076 | 15.875 +/-0.127 | BP0127-0222-0159-BSTH1 |
| 12.700 (0.500") +0.025/+0.051 (mm) | 22.225 +0.076/+0.102 | 15.875 | BP0127-0222-0159-BSTH2 |
| 12.700 (0.500") +0.051/+0.076 (mm) | 22.225 +0.051/+0.076 | 15.875 +/-0.127 | BP0127-0222-0159-BSHH |
| 12.700 (0.500") +0.025/+0.051 (mm) | 22.225 +0.051/+0.076 | 19.050 +/-0.127 | BP0127-0222-0191-BSTH1 |
| 12.700 (0.500") +0.025/+0.051 (mm) | 22.225 +0.076/+0.102 | 19.050 | BP0127-0222-0191-BSTH2 |
| 12.700 (0.500") +0.051/+0.076 (mm) | 22.225 +0.051/+0.076 | 19.050 +/-0.127 | BP0127-0222-0191-BSHH1 |
| 12.700 (0.500") +0.051/+0.076 (mm) | 22.225 +0.076/+0.102 | 19.050 +/-0.127 | BP0127-0222-0191-BSHH2 |
| 12.700 (0.500") +0.025/+0.051 (mm) | 22.225 +0.051/+0.076 | 22.225 +/-0.127 | BP0127-0222-0223-BSTH1 |
| 12.700 (0.500") +0.025/+0.051 (mm) | 22.225 +0.076/+0.102 | 22.225 | BP0127-0222-0223-BSTH2 |
| 12.700 (0.500") +0.051/+0.076 (mm) | 22.225 +0.051/+0.076 | 22.225 +/-0.127 | BP0127-0222-0223-BSHH |
| 12.700 (0.500") +0.025/+0.051 (mm) | 22.225 +0.051/+0.076 | 25.400 +/-0.127 | BP0127-0222-0254-BSTH1 |
| 12.700 (0.500") +0.025/+0.051 (mm) | 22.225 +0.076/+0.102 | 25.400 | BP0127-0222-0254-BSTH2 |
| 12.700 (0.500") +0.051/+0.076 (mm) | 22.225 +0.051/+0.076 | 25.400 +/-0.127 | BP0127-0222-0254-BSHH1 |
| 12.700 (0.500") +0.051/+0.076 (mm) | 22.225 +0.076/+0.102 | 25.400 +/-0.127 | BP0127-0222-0254-BSHH2 |
| 12.700 (0.500") +0.025/+0.051 (mm) | 22.225 +0.051/+0.076 | 31.750 +/-0.127 | BP0127-0222-0318-BSTH1 |
| 12.700 (0.500") +0.025/+0.051 (mm) | 22.225 +0.076/+0.102 | 31.750 | BP0127-0222-0318-BSTH2 |
| 12.700 (0.500") +0.051/+0.076 (mm) | 22.225 +0.051/+0.076 | 31.750 +/-0.127 | BP0127-0222-0318-BSHH1 |
| 12.700 (0.500") +0.051/+0.076 (mm) | 22.225 +0.076/+0.102 | 31.750 +/-0.127 | BP0127-0222-0318-BSHH2 |
| 12.700 (0.500") +0.025/+0.051 (mm) | 22.225 +0.051/+0.076 | 38.100 +/-0.127 | BP0127-0222-0381-BSTH1 |
| 12.700 (0.500") +0.025/+0.051 (mm) | 22.225 +0.076/+0.102 | 38.100 | BP0127-0222-0381-BSTH2 |
| 12.700 (0.500") +0.051/+0.076 (mm) | 22.225 +0.051/+0.076 | 38.100 +/-0.127 | BP0127-0222-0381-BSHH1 |
| 12.700 (0.500") +0.051/+0.076 (mm) | 22.225 +0.076/+0.102 | 38.100 +/-0.127 | BP0127-0222-0381-BSHH2 |
| 12.700 (0.500") +0.025/+0.051 (mm) | 25.400 +0.076/+0.102 | 19.050 | BP0127-0254-0191-BSTH |
| 12.700 (0.500") +0.051/+0.076 (mm) | 25.400 +0.076/+0.102 | 19.050 +/-0.127 | BP0127-0254-0191-BSHH |
| 12.700 (0.500") +0.025/+0.051 (mm) | 25.400 +0.076/+0.102 | 25.400 | BP0127-0254-0254-BSTH |
| 12.700 (0.500") +0.051/+0.076 (mm) | 25.400 +0.076/+0.102 | 25.400 +/-0.127 | BP0127-0254-0254-BSHH |
| 12.700 (0.500") +0.025/+0.051 (mm) | 25.400 +0.076/+0.102 | 38.100 | BP0127-0254-0381-BSTH |
| 12.700 (0.500") +0.051/+0.076 (mm) | 25.400 +0.076/+0.102 | 38.100 +/-0.127 | BP0127-0254-0381-BSHH |
| 12.700 (0.500") +0.025/+0.051 (mm) | 25.400 +0.076/+0.102 | 50.800 | BP0127-0254-0508-BSTH |
| 12.700 (0.500") +0.051/+0.076 (mm) | 25.400 +0.076/+0.102 | 50.800 +/-0.190 | BP0127-0254-0508-BSHH |
| 12.700 (0.500") +0.000/+0.010 (mm) | 28.575 -0.010/+0.003 | 7.938 +0/-0.127 | BP0127-0286-0079-BSLU |
| 14.000 (0.551") +0.005/+0.030 (mm) | 18.000 +0.025/+0.051 | 10.000 +/-0.127 | BP0140-0180-0100-BSLT |



Stocked or Short Delivery



Usually Available Short Delivery



Long delivery or not in current production

* Large Minimum Quantities

** Available only while stock lasts

Bushes - Plain

| Nominal ID (d) mm (inches) | Nominal OD (D) mm | Length (S) mm | Part Number |
|---------------------------------------|-------------------------|--------------------|------------------------------|
| 14.000 (0.551") +0.005/+0.030 (mm) | 18.000 +0.025/+0.051 | 14.000 +/-0.127 | BP0140-0180-0140-BSLT |
| 14.000 (0.551") +0.005/+0.030 (mm) | 18.000 +0.025/+0.051 | 15.000 +/-0.120 | BP0140-0180-0150-BSLT |
| 14.000 (0.551") +0.005/+0.030 (mm) | 18.000 +0.025/+0.051 | 18.000 +/-0.120 | BP0140-0180-0180-BSLT |
| 14.000 (0.551") +0.005/+0.030 (mm) | 18.000 +0.025/+0.051 | 19.000 +/-0.120 | BP0140-0180-0190-BSLT |
| 14.000 (0.551") +0.005/+0.030 (mm) | 18.000 +0.025/+0.051 | 20.000 +/-0.127 | BP0140-0180-0200-BSLT |
| 14.000 (0.551") +0.005/+0.030 (mm) | 18.000 +0.025/+0.051 | 22.000 +/-0.120 | BP0140-0180-0220-BSLT |
| 14.000 (0.551") +0.005/+0.030 (mm) | 18.000 +0.025/+0.051 | 26.000 +/-0.120 | BP0140-0180-0260-BSLT |
| 14.000 (0.551") +0.005/+0.030 (mm) | 18.000 +0.025/+0.051 | 28.000 +/-0.120 | BP0140-0180-0280-BSLT |
| 14.000 (0.551") +0.005/+0.030 (mm) | 20.000 +0.036/+0.061 | 10.000 +/-0.127 | BP0140-0200-0100-BSLT |
| 14.000 (0.551") +0.005/+0.030 (mm) | 20.000 +0.036/+0.061 | 12.000 +/-0.120 | BP0140-0200-0120-BSLT |
| 14.000 (0.551") +0.005/+0.030 (mm) | 20.000 +0.036/+0.061 | 14.000 +/-0.127 | BP0140-0200-0140-BSLT |
| 14.000 (0.551") +0.005/+0.030 (mm) | 20.000 +0.036/+0.061 | 15.000 +/-0.120 | BP0140-0200-0150-BSLT |
| 14.000 (0.551") +0.005/+0.030 (mm) | 20.000 +0.036/+0.061 | 18.000 +/-0.120 | BP0140-0200-0180-BSLT |
| 14.000 (0.551") +0.005/+0.030 (mm) | 20.000 +0.036/+0.061 | 20.000 +/-0.127 | BP0140-0200-0200-BSLT |
| 14.000 (0.551") +0.005/+0.030 (mm) | 20.000 +0.036/+0.061 | 22.000 +/-0.120 | BP0140-0200-0220-BSLT |
| 14.000 (0.551") +0.005/+0.030 (mm) | 20.000 +0.036/+0.061 | 25.000 +/-0.120 | BP0140-0200-0250-BSLT |
| 14.000 (0.551") +0.005/+0.030 (mm) | 20.000 +0.036/+0.061 | 28.000 +/-0.120 | BP0140-0200-0280-BSLT |
| 14.288 (0.563") +0.000/+0.025 (mm) | 17.463 +0.064/+0.089 | 11.113 +/-0.127 | BP0143-0175-0111-BSLH |
| 14.288 (0.563") +0.000/+0.025 (mm) | 17.463 +0.064/+0.089 | 12.700 +/-0.127 | BP0143-0175-0127-BSLH |
| 14.288 (0.563") +0.025/+0.051 (mm) | 17.463 +0.051/+0.076 | 12.700 +/-0.127 | BP0143-0175-0127-BSTH1 |
| 14.288 (0.563") +0.038/+0.064 (mm) | 17.463 +0.038/+0.064 | 12.700 +/-0.127 | BP0143-0175-0127-BSTT |
| 14.288 (0.563") +0.038/+0.064 (mm) | 17.463 +0.064/+0.089 | 12.700 +/-0.127 | BP0143-0175-0127-BSTH2 |
| 14.288 (0.563") +0.000/+0.025 (mm) | 17.463 +0.064/+0.089 | 15.875 +/-0.127 | BP0143-0175-0159-BSLH |
| 14.288 (0.563") +0.025/+0.051 (mm) | 17.463 +0.051/+0.076 | 15.875 +/-0.127 | BP0143-0175-0159-BSTH |
| 14.288 (0.563") +0.000/+0.025 (mm) | 17.463 +0.064/+0.089 | 19.050 +/-0.127 | BP0143-0175-0191-BSLH |
| 14.288 (0.563") +0.025/+0.051 (mm) | 17.463 +0.051/+0.076 | 19.050 +/-0.127 | BP0143-0175-0191-BSTH1 |
| 14.288 (0.563") +0.038/+0.064 (mm) | 17.463 +0.038/+0.064 | 19.050 +/-0.127 | BP0143-0175-0191-BSTT |
| 14.288 (0.563") +0.038/+0.064 (mm) | 17.463 +0.064/+0.089 | 19.050 +/-0.127 | BP0143-0175-0191-BSTH2 |
| 14.288 (0.563") +0.000/+0.025 (mm) | 17.463 +0.064/+0.089 | 25.400 +/-0.127 | BP0143-0175-0254-BSLH |
| 14.288 (0.563") +0.025/+0.051 (mm) | 17.463 +0.051/+0.076 | 25.400 +/-0.127 | BP0143-0175-0254-BSTH1 |
| 14.288 (0.563") +0.038/+0.064 (mm) | 17.463 +0.038/+0.064 | 25.400 +/-0.127 | BP0143-0175-0254-BSTT |
| 14.288 (0.563") +0.038/+0.064 (mm) | 17.463 +0.064/+0.089 | 25.400 +/-0.127 | BP0143-0175-0254-BSTH2 |
| 14.288 (0.563") +0.114/+0.140 (mm) | 17.463 +0.013/+0.038 | 28.575 +/-0.127 | BP0143-0175-0286-BSHL |
| 14.288 (0.563") +0.000/+0.025 (mm) | 17.463 +0.064/+0.089 | 31.750 +/-0.127 | BP0143-0175-0318-BSLH |



Stocked or Short Delivery



Usually Available Short Delivery



Long delivery or not in current production

* Large Minimum Quantities

** Available only while stock lasts

Bushes - Plain

| Nominal ID (d) mm (inches) | Nominal OD (D) mm | Length (S) mm | Part Number |
|---------------------------------------|-------------------------|--------------------|-------------------------------|
| 14.288 (0.563") +0.025/+0.051 (mm) | 17.463 +0.051/+0.076 | 31.750 +/-0.127 | BP0143-0175-0318-BSTH |
| 14.288 (0.563") +0.038/+0.064 (mm) | 17.463 +0.038/+0.064 | 31.750 +/-0.127 | BP0143-0175-0318-BSTT |
| 14.288 (0.563") +0.025/+0.051 (mm) | 17.463 +0.051/+0.076 | 38.100 +/-0.127 | BP0143-0175-0381-BSTH1 |
| 14.288 (0.563") +0.038/+0.064 (mm) | 17.463 +0.038/+0.064 | 38.100 +/-0.127 | BP0143-0175-0381-BSTT |
| 14.288 (0.563") +0.038/+0.064 (mm) | 17.463 +0.064/+0.089 | 38.100 +/-0.127 | BP0143-0175-0381-BSTH2 |
| 14.288 (0.563") +0.114/+0.140 (mm) | 17.463 +0.013/+0.038 | 38.100 +/-0.127 | BP0143-0175-0381-BSHL |
| 14.288 (0.563") +0.000/+0.025 (mm) | 19.050 +0.064/+0.089 | 12.700 +/-0.127 | BP0143-0191-0127-BSLH1 |
| 14.288 (0.563") +0.013/+0.038 (mm) | 19.050 +0.051/+0.076 | 12.700 +/-0.127 | BP0143-0191-0127-BSLH2 |
| 14.288 (0.563") +0.025/+0.051 (mm) | 19.050 +0.051/+0.076 | 12.700 +/-0.127 | BP0143-0191-0127-BSTH1 |
| 14.288 (0.563") +0.038/+0.064 (mm) | 19.050 +0.051/+0.076 | 12.700 +/-0.127 | BP0143-0191-0127-BSTH2 |
| 14.288 (0.563") +0.064/+0.089 (mm) | 19.050 +0.051/+0.076 | 12.700 +/-0.127 | BP0143-0191-0127-BSHH |
| 14.288 (0.563") +0.000/+0.025 (mm) | 19.050 +0.064/+0.089 | 15.875 +/-0.127 | BP0143-0191-0159-BSLH |
| 14.288 (0.563") +0.000/+0.025 (mm) | 19.050 +0.064/+0.089 | 19.050 +/-0.127 | BP0143-0191-0191-BSLH1 |
| 14.288 (0.563") +0.013/+0.038 (mm) | 19.050 +0.051/+0.076 | 19.050 +/-0.127 | BP0143-0191-0191-BSLH2 |
| 14.288 (0.563") +0.025/+0.051 (mm) | 19.050 +0.051/+0.076 | 19.050 +/-0.127 | BP0143-0191-0191-BSTH1 |
| 14.288 (0.563") +0.038/+0.064 (mm) | 19.050 +0.051/+0.076 | 19.050 +/-0.127 | BP0143-0191-0191-BSTH2 |
| 14.288 (0.563") +0.064/+0.089 (mm) | 19.050 +0.051/+0.076 | 19.050 +/-0.127 | BP0143-0191-0191-BSHH |
| 14.288 (0.563") +0.000/+0.025 (mm) | 19.050 +0.064/+0.089 | 25.400 +/-0.127 | BP0143-0191-0254-BSLH1 |
| 14.288 (0.563") +0.013/+0.038 (mm) | 19.050 +0.051/+0.076 | 25.400 +/-0.127 | BP0143-0191-0254-BSLH2 |
| 14.288 (0.563") +0.025/+0.051 (mm) | 19.050 +0.051/+0.076 | 25.400 +/-0.127 | BP0143-0191-0254-BSTH1 |
| 14.288 (0.563") +0.038/+0.064 (mm) | 19.050 +0.051/+0.076 | 25.400 +/-0.127 | BP0143-0191-0254-BSTH2 |
| 14.288 (0.563") +0.064/+0.089 (mm) | 19.050 +0.051/+0.076 | 25.400 +/-0.127 | BP0143-0191-0254-BSHH |
| 14.288 (0.563") +0.000/+0.025 (mm) | 19.050 +0.064/+0.089 | 31.750 +/-0.127 | BP0143-0191-0318-BSLH1 |
| 14.288 (0.563") +0.013/+0.038 (mm) | 19.050 +0.051/+0.076 | 31.750 +/-0.127 | BP0143-0191-0318-BSLH2 |
| 14.288 (0.563") +0.025/+0.051 (mm) | 19.050 +0.051/+0.076 | 31.750 +/-0.127 | BP0143-0191-0318-BSTH1 |
| 14.288 (0.563") +0.038/+0.064 (mm) | 19.050 +0.051/+0.076 | 31.750 +/-0.127 | BP0143-0191-0318-BSTH2 |
| 14.288 (0.563") +0.064/+0.089 (mm) | 19.050 +0.051/+0.076 | 31.750 +/-0.127 | BP0143-0191-0318-BSHH |
| 14.288 (0.563") +0.000/+0.025 (mm) | 19.050 +0.064/+0.089 | 34.925 +/-0.127 | BP0143-0191-0349-BSLH |
| 14.288 (0.563") +0.000/+0.025 (mm) | 19.050 +0.064/+0.089 | 38.100 +/-0.127 | BP0143-0191-0381-BSLH |
| 14.288 (0.563") +0.025/+0.051 (mm) | 19.050 +0.051/+0.076 | 38.100 +/-0.127 | BP0143-0191-0381-BSTH1 |
| 14.288 (0.563") +0.038/+0.064 (mm) | 19.050 +0.051/+0.076 | 38.100 +/-0.127 | BP0143-0191-0381-BSTH2 |
| 14.288 (0.563") +0.064/+0.089 (mm) | 19.050 +0.051/+0.076 | 38.100 +/-0.127 | BP0143-0191-0381-BSHH |
| 14.288 (0.563") +0.025/+0.051 (mm) | 20.638 +0.076/+0.102 | 12.700 +/-0.127 | BP0143-0206-0127-BSTH |
| 14.288 (0.563") +0.038/+0.064 (mm) | 20.638 +0.038/+0.064 | 12.700 +/-0.127 | BP0143-0206-0127-BSTT |



Stocked or Short Delivery



Usually Available Short Delivery



Long delivery or not in current production

* Large Minimum Quantities

** Available only while stock lasts

Bushes - Plain

| Nominal ID (d) mm (inches) | Nominal OD (D) mm | Length (S) mm | Part Number |
|---------------------------------------|-------------------------|--------------------|-------------------------------|
| 14.288 (0.563") +/-0.013 (mm) | 20.638 +0.038/+0.064 | 19.050 | BP0143-0206-0191-BSUT |
| 14.288 (0.563") +0.025/+0.051 (mm) | 20.638 +0.076/+0.102 | 19.050 +/-0.127 | BP0143-0206-0191-BSTH |
| 14.288 (0.563") +0.038/+0.064 (mm) | 20.638 +0.038/+0.064 | 19.050 +/-0.127 | BP0143-0206-0191-BSTT |
| 14.288 (0.563") +/-0.013 (mm) | 20.638 +0.038/+0.064 | 25.400 | BP0143-0206-0254-BSUT |
| 14.288 (0.563") +0.025/+0.051 (mm) | 20.638 +0.076/+0.102 | 25.400 +/-0.127 | BP0143-0206-0254-BSTH |
| 14.288 (0.563") +0.038/+0.064 (mm) | 20.638 +0.038/+0.064 | 25.400 +/-0.127 | BP0143-0206-0254-BSTT |
| 14.288 (0.563") +/-0.013 (mm) | 20.638 +0.038/+0.064 | 31.750 | BP0143-0206-0318-BSUT |
| 14.288 (0.563") +0.025/+0.051 (mm) | 20.638 +0.076/+0.102 | 31.750 +/-0.127 | BP0143-0206-0318-BSTH |
| 14.288 (0.563") +0.038/+0.064 (mm) | 20.638 +0.038/+0.064 | 31.750 +/-0.127 | BP0143-0206-0318-BSTT |
| 14.288 (0.563") +0.025/+0.051 (mm) | 20.638 +0.076/+0.102 | 38.100 +/-0.127 | BP0143-0206-0381-BSTH |
| 14.288 (0.563") +0.038/+0.064 (mm) | 20.638 +0.038/+0.064 | 38.100 +/-0.127 | BP0143-0206-0381-BSTT |
| 14.288 (0.563") +0.089/+0.114 (mm) | 22.225 +0.025/+0.051 | 25.400 +/-0.127 | BP0143-0222-0254-BSHT |
| 14.288 (0.563") +0.089/+0.114 (mm) | 22.225 +0.025/+0.051 | 34.925 +/-0.127 | BP0143-0222-0349-BSHT |
| 15.000 (0.591") +0.005/+0.030 (mm) | 19.000 +0.036/+0.061 | 10.000 +/-0.127 | BP0150-0190-0100-BSLT |
| 15.000 (0.591") +0.005/+0.030 (mm) | 19.000 +0.036/+0.061 | 15.000 +/-0.127 | BP0150-0190-0150-BSLT |
| 15.000 (0.591") +0.005/+0.030 (mm) | 19.000 +0.036/+0.061 | 16.000 +/-0.120 | BP0150-0190-0160-BSLT |
| 15.000 (0.591") +0.005/+0.030 (mm) | 19.000 +0.036/+0.061 | 25.000 +/-0.127 | BP0150-0190-0250-BSLT |
| 15.000 (0.591") +0.005/+0.030 (mm) | 19.000 +0.036/+0.061 | 32.000 +/-0.120 | BP0150-0190-0320-BSLT |
| 15.000 (0.591") +0.005/+0.030 (mm) | 21.000 +0.036/+0.061 | 10.000 +/-0.120 | BP0150-0210-0100-BSLT |
| 15.000 (0.591") +0.005/+0.030 (mm) | 21.000 +0.036/+0.061 | 15.000 +/-0.127 | BP0150-0210-0150-BSLT |
| 15.000 (0.591") +0.005/+0.030 (mm) | 21.000 +0.036/+0.061 | 16.000 +/-0.120 | BP0150-0210-0160-BSLT |
| 15.000 (0.591") +0.005/+0.030 (mm) | 21.000 +0.036/+0.061 | 20.000 +/-0.120 | BP0150-0210-0200-BSLT |
| 15.000 (0.591") +0.005/+0.030 (mm) | 21.000 +0.036/+0.061 | 21.000 +/-0.120 | BP0150-0210-0210-BSLT |
| 15.000 (0.591") +0.005/+0.030 (mm) | 21.000 +0.036/+0.061 | 25.000 +/-0.127 | BP0150-0210-0250-BSLT |
| 15.000 (0.591") +0.005/+0.030 (mm) | 21.000 +0.036/+0.061 | 30.000 +/-0.120 | BP0150-0210-0300-BSLT |
| 15.000 (0.591") +0.005/+0.030 (mm) | 21.000 +0.036/+0.061 | 32.000 +/-0.120 | BP0150-0210-0320-BSLT |
| 15.875 (0.625") +0.051/+0.076 (mm) | 19.050 +0.051/+0.076 | 8.712 +/-0.127 | BP0159-0191-0087-BSHH |
| 15.875 (0.625") +0.025/+0.051 (mm) | 19.050 +0.051/+0.076 | 9.525 +/-0.127 | BP0159-0191-0095-BSTH1 |
| 15.875 (0.625") +0.025/+0.051 (mm) | 19.050 +0.064/+0.089 | 9.525 +/-0.127 | BP0159-0191-0095-BSTH2 |
| 15.875 (0.625") +0.025/+0.051 (mm) | 19.050 +0.064/+0.089 | 11.049 +/-0.127 | * BP0159-0191-0110-BSTH |
| 15.875 (0.625") +0.000/+0.025 (mm) | 19.050 +0.051/+0.076 | 12.700 +/-0.127 | BP0159-0191-0127-BSLH |
| 15.875 (0.625") +0.025/+0.051 (mm) | 19.050 +0.025/+0.051 | 12.700 | BP0159-0191-0127-BSTT |
| 15.875 (0.625") +0.025/+0.051 (mm) | 19.050 +0.051/+0.076 | 12.700 +/-0.127 | BP0159-0191-0127-BSTH |
| 15.875 (0.625") +0.051/+0.076 (mm) | 19.050 +0.051/+0.076 | 12.700 +/-0.127 | BP0159-0191-0127-BSHH |



Stocked or Short Delivery



Usually Available Short Delivery



Long delivery or not in current production

* Large Minimum Quantities

** Available only while stock lasts

Bushes - Plain

| Nominal ID (d) mm (inches) | Nominal OD (D) mm | Length (S) mm | Part Number |
|---------------------------------------|-------------------------|---------------------|------------------------------|
| 15.875 (0.625") +0.025/+0.051 (mm) | 19.050 +0.025/+0.051 | 15.875 | BP0159-0191-0159-BSTT |
| 15.875 (0.625") +0.025/+0.051 (mm) | 19.050 +0.051/+0.076 | 15.875 +/-0.127 | BP0159-0191-0159-BSTH |
| 15.875 (0.625") +0.051/+0.076 (mm) | 19.050 +0.051/+0.076 | 15.875 +/-0.127 | BP0159-0191-0159-BSHH |
| 15.875 (0.625") +0.025/+0.051 (mm) | 19.050 +0.025/+0.051 | 19.050 | BP0159-0191-0191-BSTT |
| 15.875 (0.625") +0.025/+0.051 (mm) | 19.050 +0.051/+0.076 | 19.050 +/-0.127 | BP0159-0191-0191-BSTH |
| 15.875 (0.625") +0.051/+0.076 (mm) | 19.050 +0.051/+0.076 | 19.050 +/-0.127 | BP0159-0191-0191-BSHH |
| 15.875 (0.625") +0.025/+0.051 (mm) | 19.050 +0.064/+0.089 | 19.329 +0/-0.127 | BP0159-0191-0193-BSTH |
| 15.875 (0.625") +0.000/+0.025 (mm) | 19.050 +0.051/+0.076 | 22.225 +/-0.127 | BP0159-0191-0222-BSLH |
| 15.875 (0.625") +0.025/+0.051 (mm) | 19.050 +0.051/+0.076 | 22.225 +/-0.127 | BP0159-0191-0222-BSTH |
| 15.875 (0.625") +0.051/+0.076 (mm) | 19.050 +0.051/+0.076 | 22.225 +/-0.127 | BP0159-0191-0222-BSHH |
| 15.875 (0.625") +0.000/+0.025 (mm) | 19.050 +0.051/+0.076 | 25.400 +/-0.127 | BP0159-0191-0254-BSLH |
| 15.875 (0.625") +0.025/+0.051 (mm) | 19.050 +0.051/+0.076 | 25.400 +/-0.127 | BP0159-0191-0254-BSTH |
| 15.875 (0.625") +0.051/+0.076 (mm) | 19.050 +0.051/+0.076 | 25.400 +/-0.127 | BP0159-0191-0254-BSHH |
| 15.875 (0.625") +0.000/+0.025 (mm) | 19.050 +0.051/+0.076 | 28.575 +/-0.127 | BP0159-0191-0286-BSLH |
| 15.875 (0.625") +0.025/+0.051 (mm) | 19.050 +0.051/+0.076 | 28.575 +/-0.397 | BP0159-0191-0286-BSTH |
| 15.875 (0.625") +0.051/+0.076 (mm) | 19.050 +0.051/+0.076 | 28.575 +/-0.127 | BP0159-0191-0286-BSHH |
| 15.875 (0.625") +0.000/+0.025 (mm) | 19.050 +0.051/+0.076 | 31.750 +/-0.127 | BP0159-0191-0318-BSLH |
| 15.875 (0.625") +0.025/+0.051 (mm) | 19.050 +0.051/+0.076 | 31.750 +/-0.127 | BP0159-0191-0318-BSTH |
| 15.875 (0.625") +0.051/+0.076 (mm) | 19.050 +0.051/+0.076 | 31.750 +/-0.127 | BP0159-0191-0318-BSHH |
| 15.875 (0.625") +0.025/+0.051 (mm) | 19.050 +0.051/+0.076 | 38.100 +/-0.127 | BP0159-0191-0381-BSTH |
| 15.875 (0.625") +0.051/+0.076 (mm) | 19.050 +0.051/+0.076 | 38.100 +/-0.127 | BP0159-0191-0381-BSHH |
| 15.875 (0.625") +0.025/+0.051 (mm) | 20.638 +0.038/+0.064 | 12.700 +/-0.127 | BP0159-0206-0127-BSTT |
| 15.875 (0.625") +0.025/+0.051 (mm) | 20.638 +0.076/+0.102 | 12.700 +/-0.127 | BP0159-0206-0127-BSTH |
| 15.875 (0.625") +0.051/+0.076 (mm) | 20.638 +0.038/+0.064 | 12.700 +/-0.127 | BP0159-0206-0127-BSHT |
| 15.875 (0.625") +0.051/+0.076 (mm) | 20.638 +0.051/+0.076 | 12.700 +/-0.127 | BP0159-0206-0127-BSHH |
| 15.875 (0.625") -0.025/+0.000 (mm) | 20.638 +0.038/+0.064 | 12.700 +/-0.127 | BP0159-0206-0127-BSUT |
| 15.875 (0.625") +0.025/+0.051 (mm) | 20.638 +0.038/+0.064 | 15.875 +/-0.127 | BP0159-0206-0159-BSTT |
| 15.875 (0.625") +0.025/+0.051 (mm) | 20.638 +0.076/+0.102 | 15.875 +/-0.127 | BP0159-0206-0159-BSTH |
| 15.875 (0.625") +0.051/+0.076 (mm) | 20.638 +0.038/+0.064 | 15.875 +/-0.127 | BP0159-0206-0159-BSHT |
| 15.875 (0.625") -0.025/+0.000 (mm) | 20.638 +0.038/+0.064 | 15.875 +/-0.127 | BP0159-0206-0159-BSUT |
| 15.875 (0.625") +0.025/+0.051 (mm) | 20.638 +0.038/+0.064 | 19.050 +/-0.127 | BP0159-0206-0191-BSTT |
| 15.875 (0.625") +0.025/+0.051 (mm) | 20.638 +0.076/+0.102 | 19.050 +/-0.127 | BP0159-0206-0191-BSTH |
| 15.875 (0.625") +0.051/+0.076 (mm) | 20.638 +0.038/+0.064 | 19.050 +/-0.127 | BP0159-0206-0191-BSHT |
| 15.875 (0.625") +0.051/+0.076 (mm) | 20.638 +0.051/+0.076 | 19.050 +/-0.127 | BP0159-0206-0191-BSHH |



Stocked or Short Delivery



Usually Available Short Delivery



Long delivery or not in current production

* Large Minimum Quantities

** Available only while stock lasts

Bushes - Plain

| Nominal ID (d) mm (inches) | Nominal OD (D) mm | Length (S) mm | Part Number |
|---------------------------------------|-------------------------|--------------------|-------------------------------|
| 15.875 (0.625") -0.025/+0.000 (mm) | 20.638 +0.038/+0.064 | 19.050 +/-0.127 | BP0159-0206-0191-BSUT |
| 15.875 (0.625") +0.025/+0.051 (mm) | 20.638 +0.076/+0.102 | 22.225 +/-0.127 | BP0159-0206-0222-BSTH |
| 15.875 (0.625") +0.051/+0.076 (mm) | 20.638 +0.038/+0.064 | 22.225 +/-0.127 | BP0159-0206-0222-BSHT |
| 15.875 (0.625") -0.025/+0.000 (mm) | 20.638 +0.038/+0.064 | 22.225 +/-0.127 | BP0159-0206-0222-BSUT |
| 15.875 (0.625") +0.025/+0.051 (mm) | 20.638 +0.038/+0.064 | 25.400 +/-0.127 | BP0159-0206-0254-BSTT |
| 15.875 (0.625") +0.025/+0.051 (mm) | 20.638 +0.076/+0.102 | 25.400 +/-0.127 | BP0159-0206-0254-BSTH |
| 15.875 (0.625") +0.051/+0.076 (mm) | 20.638 +0.038/+0.064 | 25.400 +/-0.127 | BP0159-0206-0254-BSHT |
| 15.875 (0.625") +0.051/+0.076 (mm) | 20.638 +0.051/+0.076 | 25.400 | BP0159-0206-0254-BSHH |
| 15.875 (0.625") -0.025/+0.000 (mm) | 20.638 +0.038/+0.064 | 25.400 +/-0.127 | BP0159-0206-0254-BSUT |
| 15.875 (0.625") -0.025/+0.000 (mm) | 20.638 +0.038/+0.064 | 28.575 +/-0.127 | BP0159-0206-0286-BSUT |
| 15.875 (0.625") +0.025/+0.051 (mm) | 20.638 +0.038/+0.064 | 31.750 +/-0.127 | BP0159-0206-0318-BSTT |
| 15.875 (0.625") +0.025/+0.051 (mm) | 20.638 +0.076/+0.102 | 31.750 +/-0.127 | BP0159-0206-0318-BSTH |
| 15.875 (0.625") +0.051/+0.076 (mm) | 20.638 +0.038/+0.064 | 31.750 +/-0.127 | BP0159-0206-0318-BSHT |
| 15.875 (0.625") +0.051/+0.076 (mm) | 20.638 +0.051/+0.076 | 31.750 +/-0.127 | BP0159-0206-0318-BSHH |
| 15.875 (0.625") +0.025/+0.051 (mm) | 20.638 +0.038/+0.064 | 34.925 +/-0.127 | BP0159-0206-0349-BSTT |
| 15.875 (0.625") -0.025/+0.000 (mm) | 20.638 +0.038/+0.064 | 34.925 +/-0.127 | BP0159-0206-0349-BSUT |
| 15.875 (0.625") +0.025/+0.051 (mm) | 20.638 +0.038/+0.064 | 38.100 +/-0.127 | BP0159-0206-0381-BSTT |
| 15.875 (0.625") +0.025/+0.051 (mm) | 20.638 +0.076/+0.102 | 38.100 +/-0.127 | BP0159-0206-0381-BSTH |
| 15.875 (0.625") +0.051/+0.076 (mm) | 20.638 +0.038/+0.064 | 38.100 +/-0.127 | BP0159-0206-0381-BSHT |
| 15.875 (0.625") -0.025/+0.000 (mm) | 20.638 +0.038/+0.064 | 38.100 +/-0.127 | BP0159-0206-0381-BSUT |
| 15.875 (0.625") +0.025/+0.051 (mm) | 20.638 +0.038/+0.064 | 44.450 +/-0.190 | BP0159-0206-0445-BSTT |
| 15.875 (0.625") +0.025/+0.051 (mm) | 20.638 +0.076/+0.102 | 44.450 +/-0.190 | BP0159-0206-0445-BSTH |
| 15.875 (0.625") +0.051/+0.076 (mm) | 20.638 +0.038/+0.064 | 44.450 +/-0.190 | BP0159-0206-0445-BSHT |
| 15.875 (0.625") +0.025/+0.051 (mm) | 20.638 +0.038/+0.064 | 50.800 +/-0.190 | BP0159-0206-0508-BSTT |
| 15.875 (0.625") +0.051/+0.076 (mm) | 22.225 +0.064/+0.089 | 8.204 +/-0.127 | BP0159-0222-0082-BSHH |
| 15.875 (0.625") +0.025/+0.051 (mm) | 22.225 +0.051/+0.076 | 12.700 +/-0.127 | BP0159-0222-0127-BSTH1 |
| 15.875 (0.625") +0.025/+0.051 (mm) | 22.225 +0.076/+0.102 | 12.700 +/-0.127 | BP0159-0222-0127-BSTH2 |
| 15.875 (0.625") +0.051/+0.076 (mm) | 22.225 +0.051/+0.076 | 12.700 +/-0.127 | BP0159-0222-0127-BSHH1 |
| 15.875 (0.625") +0.051/+0.076 (mm) | 22.225 +0.064/+0.089 | 12.700 +/-0.127 | BP0159-0222-0127-BSHH2 |
| 15.875 (0.625") -0.025/+0.000 (mm) | 22.225 +0.279/+0.305 | 12.700 +/-0.127 | BP0159-0222-0127-BSUH |
| 15.875 (0.625") +0.025/+0.051 (mm) | 22.225 +0.051/+0.076 | 15.875 +/-0.127 | BP0159-0222-0159-BSTH1 |
| 15.875 (0.625") +0.025/+0.051 (mm) | 22.225 +0.076/+0.102 | 15.875 +/-0.127 | BP0159-0222-0159-BSTH2 |
| 15.875 (0.625") +0.025/+0.051 (mm) | 22.225 +0.076/+0.102 | 15.875 +/-0.127 | BP0159-0222-0159-BSTH3 |
| 15.875 (0.625") +0.051/+0.076 (mm) | 22.225 +0.051/+0.076 | 15.875 +/-0.127 | BP0159-0222-0159-BSHH1 |



Stocked or Short Delivery



Usually Available Short Delivery



Long delivery or not in current production

* Large Minimum Quantities

** Available only while stock lasts

Bushes - Plain

| Nominal ID (d) mm (inches) | Nominal OD (D) mm | Length (S) mm | Part Number |
|---------------------------------------|-------------------------|--------------------|-------------------------------|
| 15.875 (0.625") +0.051/+0.076 (mm) | 22.225 +0.064/+0.089 | 15.875 +/-0.127 | BP0159-0222-0159-BSHH2 |
| 15.875 (0.625") +0.025/+0.051 (mm) | 22.225 +0.051/+0.076 | 19.050 +/-0.127 | BP0159-0222-0191-BSTH1 |
| 15.875 (0.625") +0.025/+0.051 (mm) | 22.225 +0.076/+0.102 | 19.050 +/-0.127 | BP0159-0222-0191-BSTH2 |
| 15.875 (0.625") +0.025/+0.051 (mm) | 22.225 +0.076/+0.102 | 19.050 +/-0.127 | BP0159-0222-0191-BSTH3 |
| 15.875 (0.625") +0.051/+0.076 (mm) | 22.225 +0.051/+0.076 | 19.050 +/-0.127 | BP0159-0222-0191-BSHH |
| 15.875 (0.625") -0.025/+0.000 (mm) | 22.225 +0.279/+0.305 | 19.050 +/-0.127 | BP0159-0222-0191-BSUH |
| 15.875 (0.625") +0.025/+0.051 (mm) | 22.225 +0.051/+0.076 | 22.225 +/-0.127 | BP0159-0222-0222-BSTH1 |
| 15.875 (0.625") +0.025/+0.051 (mm) | 22.225 +0.051/+0.076 | 22.225 +/-0.127 | BP0159-0222-0222-BSTH2 |
| 15.875 (0.625") +0.051/+0.076 (mm) | 22.225 +0.051/+0.076 | 22.225 +/-0.127 | BP0159-0222-0222-BSHH |
| 15.875 (0.625") +0.025/+0.051 (mm) | 22.225 +0.051/+0.076 | 25.400 +/-0.127 | BP0159-0222-0254-BSTH1 |
| 15.875 (0.625") +0.025/+0.051 (mm) | 22.225 +0.076/+0.102 | 25.400 +/-0.127 | BP0159-0222-0254-BSTH2 |
| 15.875 (0.625") +0.025/+0.051 (mm) | 22.225 +0.076/+0.102 | 25.400 +/-0.127 | BP0159-0222-0254-BSTH3 |
| 15.875 (0.625") +0.051/+0.076 (mm) | 22.225 +0.051/+0.076 | 25.400 +/-0.127 | BP0159-0222-0254-BSHH |
| 15.875 (0.625") -0.025/+0.000 (mm) | 22.225 +0.279/+0.305 | 25.400 +/-0.127 | BP0159-0222-0254-BSUH |
| 15.875 (0.625") +0.025/+0.051 (mm) | 22.225 +0.051/+0.076 | 28.575 +/-0.127 | BP0159-0222-0286-BSTH2 |
| 15.875 (0.625") +0.025/+0.051 (mm) | 22.225 +0.051/+0.076 | 28.575 +/-0.127 | BP0159-0222-0286-BSTH1 |
| 15.875 (0.625") +0.051/+0.076 (mm) | 22.225 +0.051/+0.076 | 28.575 +/-0.127 | BP0159-0222-0286-BSHH |
| 15.875 (0.625") +0.025/+0.051 (mm) | 22.225 +0.051/+0.076 | 31.750 +/-0.127 | BP0159-0222-0318-BSTH1 |
| 15.875 (0.625") +0.025/+0.051 (mm) | 22.225 +0.051/+0.076 | 31.750 +/-0.127 | BP0159-0222-0318-BSTH2 |
| 15.875 (0.625") +0.051/+0.076 (mm) | 22.225 +0.051/+0.076 | 31.750 +/-0.127 | BP0159-0222-0318-BSHH |
| 15.875 (0.625") +0.025/+0.051 (mm) | 22.225 +0.051/+0.076 | 34.925 +/-0.127 | BP0159-0222-0349-BSTH |
| 15.875 (0.625") +0.025/+0.051 (mm) | 22.225 +0.051/+0.076 | 38.100 +/-0.127 | BP0159-0222-0381-BSTH2 |
| 15.875 (0.625") +0.025/+0.051 (mm) | 22.225 +0.051/+0.076 | 38.100 +/-0.127 | BP0159-0222-0381-BSTH1 |
| 15.875 (0.625") +0.051/+0.076 (mm) | 22.225 +0.051/+0.076 | 38.100 +/-0.127 | BP0159-0222-0381-BSHH |
| 15.875 (0.625") -0.025/+0.000 (mm) | 22.225 +0.279/+0.305 | 38.100 +/-0.127 | BP0159-0222-0381-BSUH |
| 15.875 (0.625") +0.025/+0.051 (mm) | 22.225 +0.051/+0.076 | 41.275 +/-0.190 | BP0159-0222-0413-BSTH |
| 15.875 (0.625") +0.025/+0.051 (mm) | 22.225 +0.051/+0.076 | 44.450 +/-0.190 | BP0159-0222-0445-BSTH2 |
| 15.875 (0.625") +0.025/+0.051 (mm) | 22.225 +0.051/+0.076 | 44.450 +/-0.190 | BP0159-0222-0445-BSTH1 |
| 15.875 (0.625") +0.051/+0.076 (mm) | 22.225 +0.051/+0.076 | 44.450 +/-0.190 | BP0159-0222-0445-BSHH |
| 15.875 (0.625") +0.025/+0.051 (mm) | 22.225 +0.051/+0.076 | 50.800 +/-0.190 | BP0159-0222-0508-BSTH2 |
| 15.875 (0.625") +0.025/+0.051 (mm) | 22.225 +0.051/+0.076 | 50.800 +/-0.190 | BP0159-0222-0508-BSTH1 |
| 15.875 (0.625") +0.051/+0.076 (mm) | 22.225 +0.051/+0.076 | 50.800 +/-0.190 | BP0159-0222-0508-BSHH |
| 15.875 (0.625") +0.025/+0.051 (mm) | 23.813 +0.076/+0.102 | 12.700 +/-0.127 | BP0159-0238-0127-BSTH |
| 15.875 (0.625") +0.025/+0.051 (mm) | 23.813 +0.076/+0.102 | 15.875 +/-0.127 | BP0159-0238-0159-BSTH |



Stocked or Short Delivery



Usually Available Short Delivery



Long delivery or not in current production

* Large Minimum Quantities

** Available only while stock lasts

Bushes - Plain

| Nominal ID (d) mm (inches) | Nominal OD (D) mm | Length (S) mm | Part Number |
|---------------------------------------|-------------------------|--------------------|-------------------------------|
| 15.875 (0.625") +0.051/+0.076 (mm) | 23.813 +0.038/+0.064 | 15.875 | BP0159-0238-0159-BSHT |
| 15.875 (0.625") +0.051/+0.076 (mm) | 23.813 +0.064/+0.089 | 15.875 +/-0.127 | BP0159-0238-0159-BSHH |
| 15.875 (0.625") +0.025/+0.051 (mm) | 23.813 +0.076/+0.102 | 19.050 +/-0.127 | BP0159-0238-0191-BSTH |
| 15.875 (0.625") +0.051/+0.076 (mm) | 23.813 +0.038/+0.064 | 19.050 | BP0159-0238-0191-BSHT |
| 15.875 (0.625") +0.051/+0.076 (mm) | 23.813 +0.064/+0.089 | 19.050 +/-0.127 | BP0159-0238-0191-BSHH |
| 15.875 (0.625") +0.025/+0.051 (mm) | 23.813 +0.076/+0.102 | 22.225 +/-0.127 | BP0159-0238-0222-BSTH |
| 15.875 (0.625") +0.025/+0.051 (mm) | 23.813 +0.076/+0.102 | 25.400 +/-0.127 | BP0159-0238-0254-BSTH |
| 15.875 (0.625") +0.051/+0.076 (mm) | 23.813 +0.038/+0.064 | 25.400 | BP0159-0238-0254-BSHT |
| 15.875 (0.625") +0.051/+0.076 (mm) | 23.813 +0.064/+0.089 | 25.400 +/-0.127 | BP0159-0238-0254-BSHH |
| 15.875 (0.625") +0.025/+0.051 (mm) | 23.813 +0.076/+0.102 | 31.750 +/-0.127 | BP0159-0238-0318-BSTH |
| 15.875 (0.625") +0.025/+0.051 (mm) | 23.813 +0.076/+0.102 | 38.100 +/-0.127 | BP0159-0238-0381-BSTH |
| 15.875 (0.625") +0.025/+0.051 (mm) | 23.813 +0.076/+0.102 | 44.450 +/-0.190 | BP0159-0238-0445-BSTH |
| 15.875 (0.625") +0.025/+0.051 (mm) | 23.813 +0.076/+0.102 | 50.800 +/-0.190 | BP0159-0238-0508-BSTH |
| 15.875 (0.625") +0.051/+0.076 (mm) | 25.400 +0.051/+0.076 | 12.700 +/-0.127 | BP0159-0254-0127-BSHH |
| 15.875 (0.625") +0.051/+0.076 (mm) | 25.400 +0.051/+0.076 | 15.875 +/-0.127 | BP0159-0254-0159-BSHH |
| 15.875 (0.625") +0.051/+0.076 (mm) | 25.400 +0.051/+0.076 | 19.050 +/-0.127 | BP0159-0254-0191-BSHH1 |
| 15.875 (0.625") +0.051/+0.076 (mm) | 25.400 +0.064/+0.089 | 19.050 +/-0.127 | BP0159-0254-0191-BSHH2 |
| 15.875 (0.625") +0.051/+0.076 (mm) | 25.400 +0.051/+0.076 | 22.225 +/-0.127 | BP0159-0254-0222-BSHH1 |
| 15.875 (0.625") +0.051/+0.076 (mm) | 25.400 +0.064/+0.089 | 22.225 +/-0.127 | BP0159-0254-0222-BSHH2 |
| 15.875 (0.625") +0.051/+0.076 (mm) | 25.400 +0.051/+0.076 | 25.400 +/-0.127 | BP0159-0254-0254-BSHH1 |
| 15.875 (0.625") +0.051/+0.076 (mm) | 25.400 +0.064/+0.089 | 25.400 +/-0.127 | BP0159-0254-0254-BSHH2 |
| 15.875 (0.625") +0.051/+0.076 (mm) | 25.400 +0.064/+0.089 | 28.575 +/-0.127 | BP0159-0254-0286-BSHH |
| 15.875 (0.625") +0.051/+0.076 (mm) | 25.400 +0.051/+0.076 | 31.750 +/-0.127 | BP0159-0254-0318-BSHH1 |
| 15.875 (0.625") +0.051/+0.076 (mm) | 25.400 +0.064/+0.089 | 31.750 +/-0.127 | BP0159-0254-0318-BSHH2 |
| 15.875 (0.625") +0.051/+0.076 (mm) | 25.400 +0.064/+0.089 | 34.925 +/-0.127 | BP0159-0254-0349-BSHH |
| 15.875 (0.625") +0.051/+0.076 (mm) | 25.400 +0.051/+0.076 | 38.100 +/-0.127 | BP0159-0254-0381-BSHH1 |
| 15.875 (0.625") +0.051/+0.076 (mm) | 25.400 +0.064/+0.089 | 38.100 +/-0.127 | BP0159-0254-0381-BSHH2 |
| 15.875 (0.625") +0.051/+0.076 (mm) | 25.400 +0.051/+0.076 | 44.450 +/-0.190 | BP0159-0254-0445-BSHH |
| 15.875 (0.625") +0.051/+0.076 (mm) | 25.400 +0.051/+0.076 | 50.800 +/-0.190 | BP0159-0254-0508-BSHH |
| 16.000 (0.630") +0.005/+0.030 (mm) | 20.000 +0.036/+0.061 | 12.000 +/-0.127 | BP0160-0200-0120-BSLT |
| 16.000 (0.630") +0.005/+0.030 (mm) | 20.000 +0.036/+0.061 | 16.000 +/-0.127 | BP0160-0200-0160-BSLT1 |
| 16.000 (0.630") +0.005/+0.030 (mm) | 20.000 +0.036/+0.061 | 16.000 +/-0.120 | BP0160-0200-0160-BSLT2 |
| 16.000 (0.630") +0.005/+0.030 (mm) | 20.000 +0.036/+0.061 | 20.000 +/-0.120 | BP0160-0200-0200-BSLT |
| 16.000 (0.630") +0.005/+0.030 (mm) | 20.000 +0.036/+0.061 | 25.000 +/-0.127 | BP0160-0200-0250-BSLT |



Stocked or Short Delivery



Usually Available Short Delivery



Long delivery or not in current production

* Large Minimum Quantities

** Available only while stock lasts

Bushes - Plain

| Nominal ID (d) mm (inches) | Nominal OD (D) mm | Length (S) mm | Part Number |
|---------------------------------------|-------------------------|--------------------|-------------------------------|
| 16.000 (0.630") +0.005/+0.030 (mm) | 20.000 +0.036/+0.061 | 28.000 +/-0.120 | BP0160-0200-0280-BSLT |
| 16.000 (0.630") +0.005/+0.030 (mm) | 20.000 +0.036/+0.061 | 30.000 +/-0.120 | BP0160-0200-0300-BSLT |
| 16.000 (0.630") +0.005/+0.030 (mm) | 20.000 +0.036/+0.061 | 32.000 +/-0.120 | BP0160-0200-0320-BSLT |
| 16.000 (0.630") +0.005/+0.030 (mm) | 22.000 +0.036/+0.061 | 16.000 +/-0.127 | BP0160-0220-0160-BSLT |
| 16.000 (0.630") +0.005/+0.030 (mm) | 22.000 +0.036/+0.061 | 20.000 +/-0.120 | BP0160-0220-0200-BSLT |
| 16.000 (0.630") +0.005/+0.030 (mm) | 22.000 +0.036/+0.061 | 22.000 +/-0.120 | BP0160-0220-0220-BSLT |
| 16.000 (0.630") +0.005/+0.030 (mm) | 22.000 +0.036/+0.061 | 25.000 +/-0.127 | BP0160-0220-0250-BSLT |
| 16.000 (0.630") +0.005/+0.030 (mm) | 22.000 +0.036/+0.061 | 30.000 +/-0.127 | BP0160-0220-0300-BSLT |
| 16.000 (0.630") +0.005/+0.030 (mm) | 22.000 +0.036/+0.061 | 32.000 +/-0.120 | BP0160-0220-0320-BSLT |
| 17.463 (0.688") +0.000/+0.025 (mm) | 20.638 +0.038/+0.064 | 25.400 +/-0.127 | BP0175-0206-0254-BSLT |
| 17.463 (0.688") +0.000/+0.025 (mm) | 20.638 +0.038/+0.064 | 31.750 +/-0.127 | BP0175-0206-0318-BSLT |
| 17.463 (0.688") +0.038/+0.064 (mm) | 22.225 +0.051/+0.076 | 12.700 +/-0.127 | BP0175-0222-0127-BSTH |
| 17.463 (0.688") +0.025/+0.051 (mm) | 22.225 +0.076/+0.102 | 19.050 +/-0.127 | BP0175-0222-0191-BSTH1 |
| 17.463 (0.688") +0.038/+0.064 (mm) | 22.225 +0.051/+0.076 | 19.050 +/-0.127 | BP0175-0222-0191-BSTH2 |
| 17.463 (0.688") +0.025/+0.051 (mm) | 22.225 +0.076/+0.102 | 25.400 +/-0.127 | BP0175-0222-0254-BSTH1 |
| 17.463 (0.688") +0.038/+0.064 (mm) | 22.225 +0.051/+0.076 | 25.400 +/-0.127 | BP0175-0222-0254-BSTH2 |
| 17.463 (0.688") +0.038/+0.064 (mm) | 22.225 +0.051/+0.076 | 28.575 +/-0.127 | BP0175-0222-0286-BSTH |
| 17.463 (0.688") +0.025/+0.051 (mm) | 22.225 +0.076/+0.102 | 31.750 +/-0.127 | BP0175-0222-0318-BSTH1 |
| 17.463 (0.688") +0.038/+0.064 (mm) | 22.225 +0.051/+0.076 | 31.750 +/-0.127 | BP0175-0222-0318-BSTH2 |
| 17.463 (0.688") +0.025/+0.051 (mm) | 22.225 +0.076/+0.102 | 38.100 +/-0.127 | BP0175-0222-0381-BSTH1 |
| 17.463 (0.688") +0.038/+0.064 (mm) | 22.225 +0.051/+0.076 | 38.100 +/-0.127 | BP0175-0222-0381-BSTH2 |
| 17.463 (0.688") +0.025/+0.051 (mm) | 22.225 +0.076/+0.102 | 44.450 +/-0.190 | BP0175-0222-0445-BSTH1 |
| 17.463 (0.688") +0.038/+0.064 (mm) | 22.225 +0.051/+0.076 | 44.450 +/-0.190 | BP0175-0222-0445-BSTH2 |
| 17.463 (0.688") +0.025/+0.051 (mm) | 22.225 +0.076/+0.102 | 50.800 +/-0.190 | BP0175-0222-0508-BSTH1 |
| 17.463 (0.688") +0.038/+0.064 (mm) | 22.225 +0.051/+0.076 | 50.800 +/-0.190 | BP0175-0222-0508-BSTH2 |
| 17.463 (0.688") +0.013/+0.038 (mm) | 23.813 +0.064/+0.089 | 25.400 +/-0.127 | BP0175-0238-0254-BSLH |
| 17.463 (0.688") +0.013/+0.038 (mm) | 23.813 +0.064/+0.089 | 31.750 +/-0.127 | BP0175-0238-0318-BSLH |
| 17.463 (0.688") +0.013/+0.038 (mm) | 23.813 +0.064/+0.089 | 38.100 +/-0.127 | BP0175-0238-0381-BSLH |
| 18.000 (0.709") +0.005/+0.030 (mm) | 22.000 +0.036/+0.061 | 12.000 +/-0.127 | BP0180-0220-0120-BSLT |
| 18.000 (0.709") +0.005/+0.030 (mm) | 22.000 +0.036/+0.061 | 18.000 +/-0.127 | BP0180-0220-0180-BSLT |
| 18.000 (0.709") +0.005/+0.030 (mm) | 22.000 +0.036/+0.061 | 22.000 +/-0.120 | BP0180-0220-0220-BSLT |
| 18.000 (0.709") +0.005/+0.030 (mm) | 22.000 +0.036/+0.061 | 28.000 +/-0.120 | BP0180-0220-0280-BSLT |
| 18.000 (0.709") +0.005/+0.030 (mm) | 22.000 +0.036/+0.061 | 36.000 +/-0.120 | BP0180-0220-0360-BSLT |
| 18.000 (0.709") +0.005/+0.030 (mm) | 24.000 +0.036/+0.061 | 12.000 +/-0.120 | BP0180-0240-0120-BSLT |



Stocked or Short Delivery



Usually Available Short Delivery



Long delivery or not in current production

* Large Minimum Quantities

** Available only while stock lasts

Bushes - Plain

| Nominal ID (d) mm (inches) | Nominal OD (D) mm | Length (S) mm | Part Number |
|-------------------------------|----------------------|---------------|-------------------------------|
| 18.000 (0.709") | 24.000 | 17.000 | BP0180-0240-0170-BSLT |
| +0.005/+0.030 (mm) | +0.036/+0.061 | +/-0.120 | |
| 18.000 (0.709") | 24.000 | 18.000 | BP0180-0240-0180-BSLT |
| +0.005/+0.030 (mm) | +0.036/+0.061 | +/-0.127 | |
| 18.000 (0.709") | 24.000 | 22.000 | BP0180-0240-0220-BSLT |
| +0.005/+0.030 (mm) | +0.036/+0.061 | +/-0.120 | |
| 18.000 (0.709") | 24.000 | 24.000 | BP0180-0240-0240-BSLT |
| +0.005/+0.030 (mm) | +0.036/+0.061 | +/-0.120 | |
| 18.000 (0.709") | 24.000 | 25.000 | BP0180-0240-0250-BSLT |
| +0.005/+0.030 (mm) | +0.036/+0.061 | +/-0.120 | |
| 18.000 (0.709") | 24.000 | 28.000 | BP0180-0240-0280-BSLT |
| +0.005/+0.030 (mm) | +0.036/+0.061 | +/-0.120 | |
| 18.000 (0.709") | 24.000 | 30.000 | BP0180-0240-0300-BSLT |
| +0.005/+0.030 (mm) | +0.036/+0.061 | +/-0.127 | |
| 18.000 (0.709") | 24.000 | 36.000 | BP0180-0240-0360-BSLT |
| +0.005/+0.030 (mm) | +0.036/+0.061 | +/-0.120 | |
| 18.000 (0.709") | 25.000 | 22.000 | BP0180-0250-0220-BSLT |
| +0.005/+0.030 (mm) | +0.036/+0.061 | +/-0.120 | |
| 18.000 (0.709") | 25.000 | 28.000 | BP0180-0250-0280-BSLT |
| +0.005/+0.030 (mm) | +0.036/+0.061 | +/-0.120 | |
| 18.000 (0.709") | 25.000 | 36.000 | BP0180-0250-0360-BSLT |
| +0.005/+0.030 (mm) | +0.036/+0.061 | +/-0.120 | |
| 19.050 (0.750") | 22.225 | 12.700 | BP0191-0222-0127-BSTH |
| +0.025/+0.051 (mm) | +0.076/+0.102 | +/-0.127 | |
| 19.050 (0.750") | 22.225 | 12.700 | BP0191-0222-0127-BSHH |
| +0.051/+0.076 (mm) | +0.051/+0.076 | +/-0.127 | |
| 19.050 (0.750") | 22.225 | 14.288 | BP0191-0222-0143-BSLH |
| +0.000/+0.025 (mm) | +0.051/+0.076 | +/-0.127 | |
| 19.050 (0.750") | 22.225 | 14.288 | BP0191-0222-0143-BSTH |
| +0.025/+0.051 (mm) | +0.076/+0.102 | +/-0.127 | |
| 19.050 (0.750") | 22.225 | 15.875 | BP0191-0222-0159-BSLH |
| +0.000/+0.025 (mm) | +0.051/+0.076 | +/-0.127 | |
| 19.050 (0.750") | 22.225 | 15.875 | BP0191-0222-0159-BSTH |
| +0.025/+0.051 (mm) | +0.076/+0.102 | +/-0.127 | |
| 19.050 (0.750") | 22.225 | 15.875 | BP0191-0222-0159-BSHH |
| +0.051/+0.076 (mm) | +0.051/+0.076 | +/-0.127 | |
| 19.050 (0.750") | 22.225 | 17.463 | BP0191-0222-0175-BSTH |
| +0.025/+0.051 (mm) | +0.076/+0.102 | +/-0.127 | |
| 19.050 (0.750") | 22.225 | 17.463 | BP0191-0222-0175-BSHH |
| +0.051/+0.076 (mm) | +0.051/+0.076 | +/-0.127 | |
| 19.050 (0.750") | 22.225 | 19.050 | BP0191-0222-0191-BSLH |
| +0.000/+0.025 (mm) | +0.051/+0.076 | +/-0.127 | |
| 19.050 (0.750") | 22.225 | 19.050 | BP0191-0222-0191-BSTH1 |
| +0.025/+0.051 (mm) | +0.051/+0.076 | +/-0.127 | |
| 19.050 (0.750") | 22.225 | 19.050 | BP0191-0222-0191-BSTH2 |
| +0.025/+0.051 (mm) | +0.076/+0.102 | +/-0.127 | |
| 19.050 (0.750") | 22.225 | 19.050 | BP0191-0222-0191-BSHH |
| +0.051/+0.076 (mm) | +0.051/+0.076 | +/-0.127 | |
| 19.050 (0.750") | 22.225 | 22.225 | BP0191-0222-0223-BSLH |
| +0.000/+0.025 (mm) | +0.051/+0.076 | | |
| 19.050 (0.750") | 22.225 | 22.225 | BP0191-0222-0223-BSTH |
| +0.025/+0.051 (mm) | +0.076/+0.102 | +/-0.127 | |
| 19.050 (0.750") | 22.225 | 22.225 | BP0191-0222-0223-BSHH |
| +0.051/+0.076 (mm) | +0.051/+0.076 | +/-0.127 | |
| 19.050 (0.750") | 22.225 | 25.400 | BP0191-0222-0254-BSLH |
| +0.000/+0.025 (mm) | +0.051/+0.076 | +/-0.127 | |
| 19.050 (0.750") | 22.225 | 25.400 | BP0191-0222-0254-BSTH1 |
| +0.025/+0.051 (mm) | +0.051/+0.076 | +/-0.127 | |
| 19.050 (0.750") | 22.225 | 25.400 | BP0191-0222-0254-BSTH2 |
| +0.025/+0.051 (mm) | +0.076/+0.102 | +/-0.127 | |
| 19.050 (0.750") | 22.225 | 25.400 | BP0191-0222-0254-BSHH |
| +0.051/+0.076 (mm) | +0.051/+0.076 | +/-0.127 | |
| 19.050 (0.750") | 22.225 | 28.575 | BP0191-0222-0286-BSLH |
| +0.000/+0.025 (mm) | +0.051/+0.076 | +/-0.127 | |
| 19.050 (0.750") | 22.225 | 28.575 | BP0191-0222-0286-BSTH |
| +0.025/+0.051 (mm) | +0.076/+0.102 | +/-0.127 | |
| 19.050 (0.750") | 22.225 | 28.575 | BP0191-0222-0286-BSHH |
| +0.051/+0.076 (mm) | +0.051/+0.076 | +/-0.127 | |



Stocked or Short Delivery



Usually Available Short Delivery



Long delivery or not in current production

* Large Minimum Quantities

** Available only while stock lasts

Bushes - Plain

| Nominal ID (d) mm (inches) | Nominal OD (D) mm | Length (S) mm | Part Number |
|---------------------------------------|-------------------------|--------------------|-------------------------------|
| 19.050 (0.750") +0.000/+0.025 (mm) | 22.225 +0.051/+0.076 | 31.750 +/-0.127 | BP0191-0222-0318-BSLH |
| 19.050 (0.750") +0.025/+0.051 (mm) | 22.225 +0.051/+0.076 | 31.750 +/-0.127 | BP0191-0222-0318-BSTH1 |
| 19.050 (0.750") +0.025/+0.051 (mm) | 22.225 +0.076/+0.102 | 31.750 +/-0.127 | BP0191-0222-0318-BSTH2 |
| 19.050 (0.750") +0.051/+0.076 (mm) | 22.225 +0.051/+0.076 | 31.750 +/-0.127 | BP0191-0222-0318-BSHH |
| 19.050 (0.750") +0.000/+0.025 (mm) | 22.225 +0.051/+0.076 | 34.925 +/-0.127 | BP0191-0222-0349-BSLH |
| 19.050 (0.750") +0.000/+0.025 (mm) | 22.225 +0.051/+0.076 | 38.100 +/-0.127 | BP0191-0222-0381-BSLH |
| 19.050 (0.750") +0.025/+0.051 (mm) | 22.225 +0.076/+0.102 | 38.100 +/-0.127 | BP0191-0222-0381-BSTH |
| 19.050 (0.750") +0.051/+0.076 (mm) | 22.225 +0.051/+0.076 | 38.100 +/-0.127 | BP0191-0222-0381-BSHH |
| 19.050 (0.750") +0.000/+0.025 (mm) | 22.225 +0.051/+0.076 | 41.275 +/-0.127 | BP0191-0222-0413-BSLH |
| 19.050 (0.750") +0.025/+0.051 (mm) | 22.225 +0.076/+0.102 | 41.275 +/-0.190 | BP0191-0222-0413-BSTH |
| 19.050 (0.750") +0.051/+0.076 (mm) | 22.225 +0.051/+0.076 | 41.275 +/-0.190 | BP0191-0222-0413-BSHH |
| 19.050 (0.750") +0.025/+0.051 (mm) | 23.813 +0.051/+0.076 | 12.700 +/-0.127 | BP0191-0238-0127-BSTH |
| 19.050 (0.750") +0.051/+0.076 (mm) | 23.813 +0.051/+0.076 | 12.700 +/-0.127 | BP0191-0238-0127-BSHH1 |
| 19.050 (0.750") +0.051/+0.076 (mm) | 23.813 +0.064/+0.089 | 12.700 +/-0.127 | BP0191-0238-0127-BSHH2 |
| 19.050 (0.750") +0.025/+0.051 (mm) | 23.813 +0.051/+0.076 | 15.875 +/-0.127 | BP0191-0238-0159-BSTH |
| 19.050 (0.750") +0.051/+0.076 (mm) | 23.813 +0.051/+0.076 | 15.875 +/-0.127 | BP0191-0238-0159-BSHH1 |
| 19.050 (0.750") +0.051/+0.076 (mm) | 23.813 +0.064/+0.089 | 15.875 +/-0.127 | BP0191-0238-0159-BSHH2 |
| 19.050 (0.750") +0.013/+0.038 (mm) | 23.813 +0.038/+0.064 | 19.050 | BP0191-0238-0191-BSLT |
| 19.050 (0.750") +0.025/+0.051 (mm) | 23.813 +0.051/+0.076 | 19.050 +/-0.127 | BP0191-0238-0191-BSTH |
| 19.050 (0.750") +0.051/+0.076 (mm) | 23.813 +0.051/+0.076 | 19.050 +/-0.127 | BP0191-0238-0191-BSHH1 |
| 19.050 (0.750") +0.051/+0.076 (mm) | 23.813 +0.064/+0.089 | 19.050 +/-0.127 | BP0191-0238-0191-BSHH2 |
| 19.050 (0.750") +0.025/+0.051 (mm) | 23.813 +0.051/+0.076 | 22.225 +/-0.127 | BP0191-0238-0222-BSTH |
| 19.050 (0.750") +0.051/+0.076 (mm) | 23.813 +0.051/+0.076 | 22.225 +/-0.127 | BP0191-0238-0222-BSHH1 |
| 19.050 (0.750") +0.051/+0.076 (mm) | 23.813 +0.064/+0.089 | 22.225 +/-0.127 | BP0191-0238-0222-BSHH2 |
| 19.050 (0.750") +0.013/+0.038 (mm) | 23.813 +0.038/+0.064 | 25.400 +/-0.127 | BP0191-0238-0254-BSLT |
| 19.050 (0.750") +0.025/+0.051 (mm) | 23.813 +0.051/+0.076 | 25.400 +/-0.127 | BP0191-0238-0254-BSTH1 |
| 19.050 (0.750") +0.025/+0.051 (mm) | 23.813 +0.089/+0.114 | 25.400 +/-0.127 | BP0191-0238-0254-BSTH2 |
| 19.050 (0.750") +0.051/+0.076 (mm) | 23.813 +0.051/+0.076 | 25.400 +/-0.127 | BP0191-0238-0254-BSHH1 |
| 19.050 (0.750") +0.051/+0.076 (mm) | 23.813 +0.064/+0.089 | 25.400 +/-0.127 | BP0191-0238-0254-BSHH2 |
| 19.050 (0.750") +0.013/+0.038 (mm) | 23.813 +0.038/+0.064 | 28.575 | BP0191-0238-0286-BSLT |
| 19.050 (0.750") +0.025/+0.051 (mm) | 23.813 +0.051/+0.076 | 28.575 +/-0.127 | BP0191-0238-0286-BSTH |
| 19.050 (0.750") +0.051/+0.076 (mm) | 23.813 +0.064/+0.089 | 28.575 +/-0.127 | BP0191-0238-0286-BSHH |
| 19.050 (0.750") +0.013/+0.038 (mm) | 23.813 +0.038/+0.064 | 31.750 | BP0191-0238-0318-BSLT |
| 19.050 (0.750") +0.025/+0.051 (mm) | 23.813 +0.051/+0.076 | 31.750 +/-0.127 | BP0191-0238-0318-BSTH1 |

Stocked or Short Delivery
 Usually Available Short Delivery
 Long delivery or not in current production

* Large Minimum Quantities

** Available only while stock lasts

Bushes - Plain

| Nominal ID (d) mm (inches) | Nominal OD (D) mm | Length (S) mm | Part Number |
|---------------------------------------|-------------------------|--------------------|-------------------------------|
| 19.050 (0.750") +0.025/+0.051 (mm) | 23.813 +0.089/+0.114 | 31.750 +/-0.127 | BP0191-0238-0318-BSTH2 |
| 19.050 (0.750") +0.051/+0.076 (mm) | 23.813 +0.051/+0.076 | 31.750 +/-0.127 | BP0191-0238-0318-BSHH1 |
| 19.050 (0.750") +0.051/+0.076 (mm) | 23.813 +0.064/+0.089 | 31.750 +/-0.127 | BP0191-0238-0318-BSHH2 |
| 19.050 (0.750") +0.025/+0.051 (mm) | 23.813 +0.089/+0.114 | 34.925 +/-0.127 | BP0191-0238-0349-BSTH |
| 19.050 (0.750") +0.013/+0.038 (mm) | 23.813 +0.038/+0.064 | 38.100 +/-0.127 | BP0191-0238-0381-BSLT |
| 19.050 (0.750") +0.025/+0.051 (mm) | 23.813 +0.051/+0.076 | 38.100 +/-0.127 | BP0191-0238-0381-BSTH1 |
| 19.050 (0.750") +0.025/+0.051 (mm) | 23.813 +0.089/+0.114 | 38.100 +/-0.127 | BP0191-0238-0381-BSTH2 |
| 19.050 (0.750") +0.051/+0.076 (mm) | 23.813 +0.051/+0.076 | 38.100 +/-0.127 | BP0191-0238-0381-BSHH1 |
| 19.050 (0.750") +0.051/+0.076 (mm) | 23.813 +0.064/+0.089 | 38.100 +/-0.127 | BP0191-0238-0381-BSHH2 |
| 19.050 (0.750") +0.025/+0.051 (mm) | 23.813 +0.051/+0.076 | 41.275 +/-0.190 | BP0191-0238-0413-BSTH1 |
| 19.050 (0.750") +0.025/+0.051 (mm) | 23.813 +0.089/+0.114 | 41.275 | BP0191-0238-0413-BSTH2 |
| 19.050 (0.750") +0.051/+0.076 (mm) | 23.813 +0.064/+0.089 | 41.275 +/-0.190 | BP0191-0238-0413-BSHH |
| 19.050 (0.750") +0.013/+0.038 (mm) | 23.813 +0.038/+0.064 | 44.450 +/-0.190 | BP0191-0238-0445-BSLT |
| 19.050 (0.750") +0.025/+0.051 (mm) | 23.813 +0.051/+0.076 | 44.450 +/-0.190 | BP0191-0238-0445-BSTH1 |
| 19.050 (0.750") +0.025/+0.051 (mm) | 23.813 +0.089/+0.114 | 44.450 +/-0.190 | BP0191-0238-0445-BSTH2 |
| 19.050 (0.750") +0.051/+0.076 (mm) | 23.813 +0.051/+0.076 | 44.450 +/-0.190 | BP0191-0238-0445-BSHH1 |
| 19.050 (0.750") +0.051/+0.076 (mm) | 23.813 +0.064/+0.089 | 44.450 +/-0.190 | BP0191-0238-0445-BSHH2 |
| 19.050 (0.750") +0.025/+0.051 (mm) | 23.813 +0.051/+0.076 | 47.625 +/-0.190 | BP0191-0238-0476-BSTH |
| 19.050 (0.750") +0.051/+0.076 (mm) | 23.813 +0.064/+0.089 | 47.625 +/-0.190 | BP0191-0238-0476-BSHH |
| 19.050 (0.750") +0.013/+0.038 (mm) | 23.813 +0.038/+0.064 | 50.800 | BP0191-0238-0508-BSLT |
| 19.050 (0.750") +0.025/+0.051 (mm) | 23.813 +0.051/+0.076 | 50.800 +/-0.190 | BP0191-0238-0508-BSTH |
| 19.050 (0.750") +0.051/+0.076 (mm) | 23.813 +0.051/+0.076 | 50.800 +/-0.190 | BP0191-0238-0508-BSHH1 |
| 19.050 (0.750") +0.051/+0.076 (mm) | 23.813 +0.064/+0.089 | 50.800 +/-0.190 | BP0191-0238-0508-BSHH2 |
| 19.050 (0.750") +0.025/+0.051 (mm) | 25.400 +0.038/+0.064 | 9.525 +/-0.127 | BP0191-0254-0095-BSTT |
| 19.050 (0.750") +0.025/+0.051 (mm) | 25.400 +0.038/+0.064 | 12.700 | BP0191-0254-0127-BSTT |
| 19.050 (0.750") +0.025/+0.051 (mm) | 25.400 +0.076/+0.102 | 12.700 +/-0.127 | BP0191-0254-0127-BSTH |
| 19.050 (0.750") +0.051/+0.076 (mm) | 25.400 +0.051/+0.076 | 12.700 +/-0.127 | BP0191-0254-0127-BSHH |
| 19.050 (0.750") +0.025/+0.051 (mm) | 25.400 +0.076/+0.102 | 15.875 +/-0.127 | BP0191-0254-0159-BSTH |
| 19.050 (0.750") +0.051/+0.076 (mm) | 25.400 +0.051/+0.076 | 15.875 +/-0.127 | BP0191-0254-0159-BSHH |
| 19.050 (0.750") +/-0.013 (mm) | 25.400 +0.038/+0.064 | 19.050 +/-0.127 | BP0191-0254-0191-BSUT |
| 19.050 (0.750") +0.025/+0.051 (mm) | 25.400 +0.038/+0.064 | 19.050 +/-0.127 | BP0191-0254-0191-BSTT |
| 19.050 (0.750") +0.025/+0.051 (mm) | 25.400 +0.076/+0.102 | 19.050 +/-0.127 | BP0191-0254-0191-BSTH |
| 19.050 (0.750") +0.051/+0.076 (mm) | 25.400 +0.051/+0.076 | 19.050 +/-0.127 | BP0191-0254-0191-BSHH |
| 19.050 (0.750") +0.025/+0.051 (mm) | 25.400 +0.038/+0.064 | 22.225 | BP0191-0254-0222-BSTT |



Stocked or Short Delivery



Usually Available Short Delivery



Long delivery or not in current production

* Large Minimum Quantities

** Available only while stock lasts

Bushes - Plain

| Nominal ID (d) mm (inches) | Nominal OD (D) mm | Length (S) mm | Part Number |
|---------------------------------------|-------------------------|--------------------|------------------------------|
| 19.050 (0.750") +0.025/+0.051 (mm) | 25.400 +0.076/+0.102 | 22.225 +/-0.127 | BP0191-0254-0222-BSTH |
| 19.050 (0.750") +0.051/+0.076 (mm) | 25.400 +0.051/+0.076 | 22.225 +/-0.127 | BP0191-0254-0222-BSHH |
| 19.050 (0.750") +/-0.013 (mm) | 25.400 +0.038/+0.064 | 25.400 +/-0.127 | BP0191-0254-0254-BSUT |
| 19.050 (0.750") +0.025/+0.051 (mm) | 25.400 +0.038/+0.064 | 25.400 +/-0.127 | BP0191-0254-0254-BSTT |
| 19.050 (0.750") +0.025/+0.051 (mm) | 25.400 +0.076/+0.102 | 25.400 +/-0.127 | BP0191-0254-0254-BSTH |
| 19.050 (0.750") +0.051/+0.076 (mm) | 25.400 +0.051/+0.076 | 25.400 +/-0.127 | BP0191-0254-0254-BSHH |
| 19.050 (0.750") +/-0.013 (mm) | 25.400 +0.038/+0.064 | 28.575 +/-0.127 | BP0191-0254-0286-BSUT |
| 19.050 (0.750") +0.025/+0.051 (mm) | 25.400 +0.038/+0.064 | 28.575 +/-0.127 | BP0191-0254-0286-BSTT |
| 19.050 (0.750") +0.025/+0.051 (mm) | 25.400 +0.076/+0.102 | 28.575 +/-0.127 | BP0191-0254-0286-BSTH |
| 19.050 (0.750") +0.051/+0.076 (mm) | 25.400 +0.051/+0.076 | 28.575 +/-0.127 | BP0191-0254-0286-BSHH |
| 19.050 (0.750") +/-0.013 (mm) | 25.400 +0.038/+0.064 | 31.750 +/-0.127 | BP0191-0254-0318-BSUT |
| 19.050 (0.750") +0.025/+0.051 (mm) | 25.400 +0.038/+0.064 | 31.750 +/-0.127 | BP0191-0254-0318-BSTT |
| 19.050 (0.750") +0.025/+0.051 (mm) | 25.400 +0.076/+0.102 | 31.750 +/-0.127 | BP0191-0254-0318-BSTH |
| 19.050 (0.750") +0.051/+0.076 (mm) | 25.400 +0.051/+0.076 | 31.750 +/-0.127 | BP0191-0254-0318-BSHH |
| 19.050 (0.750") +0.025/+0.051 (mm) | 25.400 +0.038/+0.064 | 34.925 +/-0.127 | BP0191-0254-0349-BSTT |
| 19.050 (0.750") +/-0.013 (mm) | 25.400 +0.038/+0.064 | 38.100 +/-0.127 | BP0191-0254-0381-BSUT |
| 19.050 (0.750") +0.025/+0.051 (mm) | 25.400 +0.038/+0.064 | 38.100 +/-0.127 | BP0191-0254-0381-BSTT |
| 19.050 (0.750") +0.025/+0.051 (mm) | 25.400 +0.076/+0.102 | 38.100 +/-0.127 | BP0191-0254-0381-BSTH |
| 19.050 (0.750") +0.051/+0.076 (mm) | 25.400 +0.051/+0.076 | 38.100 +/-0.127 | BP0191-0254-0381-BSHH |
| 19.050 (0.750") +0.025/+0.051 (mm) | 25.400 +0.038/+0.064 | 44.450 +/-0.127 | BP0191-0254-0445-BSTT |
| 19.050 (0.750") +0.025/+0.051 (mm) | 25.400 +0.076/+0.102 | 44.450 +/-0.190 | BP0191-0254-0445-BSTH |
| 19.050 (0.750") +0.051/+0.076 (mm) | 25.400 +0.051/+0.076 | 44.450 +/-0.190 | BP0191-0254-0445-BSHH |
| 19.050 (0.750") +0.025/+0.051 (mm) | 25.400 +0.178/+0.203 | 47.625 +/-0.397 | BP0191-0254-0476-BSTH |
| 19.050 (0.750") +0.025/+0.051 (mm) | 25.400 +0.038/+0.064 | 50.800 +/-0.127 | BP0191-0254-0508-BSTT |
| 19.050 (0.750") +0.025/+0.051 (mm) | 25.400 +0.076/+0.102 | 50.800 +/-0.190 | BP0191-0254-0508-BSTH |
| 19.050 (0.750") +0.051/+0.076 (mm) | 25.400 +0.051/+0.076 | 50.800 +/-0.190 | BP0191-0254-0508-BSHH |
| 19.050 (0.750") +0.025/+0.051 (mm) | 25.400 +0.038/+0.064 | 53.975 +/-0.190 | BP0191-0254-0540-BSTT |
| 19.050 (0.750") +0.025/+0.051 (mm) | 25.400 +0.038/+0.064 | 57.150 +/-0.190 | BP0191-0254-0572-BSTT |
| 19.050 (0.750") +0.025/+0.051 (mm) | 25.400 +0.038/+0.064 | 63.500 +/-0.127 | BP0191-0254-0635-BSTT |
| 19.050 (0.750") +0.025/+0.051 (mm) | 25.400 +0.076/+0.102 | 63.500 +/-0.190 | BP0191-0254-0635-BSTH |
| 19.050 (0.750") +0.051/+0.076 (mm) | 25.400 +0.051/+0.076 | 63.500 +/-0.190 | BP0191-0254-0635-BSHH |
| 19.050 (0.750") +0.000/+0.025 (mm) | 26.988 +0.025/+0.051 | 25.400 +/-0.127 | BP0191-0270-0254-BSLT |
| 19.050 (0.750") +0.000/+0.025 (mm) | 26.988 +0.025/+0.051 | 31.750 +/-0.127 | BP0191-0270-0318-BSLT |
| 19.050 (0.750") +0.025/+0.051 (mm) | 28.575 +0.076/+0.102 | 12.700 +/-0.127 | BP0191-0286-0127-BSTH |



Stocked or Short Delivery



Usually Available Short Delivery



Long delivery or not in current production

* Large Minimum Quantities

** Available only while stock lasts

Bushes - Plain

| Nominal ID (d) mm (inches) | Nominal OD (D) mm | Length (S) mm | Part Number |
|---------------------------------------|-------------------------|--------------------|------------------------------|
| 19.050 (0.750") +0.051/+0.076 (mm) | 28.575 +0.051/+0.076 | 12.700 +/-0.127 | BP0191-0286-0127-BSHH |
| 19.050 (0.750") +0.025/+0.051 (mm) | 28.575 +0.076/+0.102 | 19.050 +/-0.127 | BP0191-0286-0191-BSTH |
| 19.050 (0.750") +0.051/+0.076 (mm) | 28.575 +0.051/+0.076 | 19.050 +/-0.127 | BP0191-0286-0191-BSHH |
| 19.050 (0.750") -0.025/+0.000 (mm) | 28.575 +0.076/+0.102 | 19.050 +/-0.127 | BP0191-0286-0191-BSUH |
| 19.050 (0.750") +0.025/+0.051 (mm) | 28.575 +0.076/+0.102 | 25.400 +/-0.127 | BP0191-0286-0254-BSTH |
| 19.050 (0.750") +0.051/+0.076 (mm) | 28.575 +0.051/+0.076 | 25.400 +/-0.127 | BP0191-0286-0254-BSHH |
| 19.050 (0.750") +0.025/+0.051 (mm) | 28.575 +0.076/+0.102 | 31.750 +/-0.127 | BP0191-0286-0318-BSTH |
| 19.050 (0.750") +0.051/+0.076 (mm) | 28.575 +0.051/+0.076 | 31.750 +/-0.127 | BP0191-0286-0318-BSHH |
| 19.050 (0.750") -0.025/+0.000 (mm) | 28.575 +0.076/+0.102 | 31.750 +/-0.127 | BP0191-0286-0318-BSUH |
| 19.050 (0.750") +0.051/+0.076 (mm) | 28.575 +0.051/+0.076 | 34.925 +/-0.127 | BP0191-0286-0349-BSHH |
| 19.050 (0.750") +0.025/+0.051 (mm) | 28.575 +0.076/+0.102 | 38.100 +/-0.127 | BP0191-0286-0381-BSTH |
| 19.050 (0.750") +0.051/+0.076 (mm) | 28.575 +0.051/+0.076 | 38.100 +/-0.127 | BP0191-0286-0381-BSHH |
| 19.050 (0.750") +0.025/+0.051 (mm) | 28.575 +0.076/+0.102 | 44.450 +/-0.190 | BP0191-0286-0445-BSTH |
| 19.050 (0.750") +0.051/+0.076 (mm) | 28.575 +0.051/+0.076 | 44.450 +/-0.190 | BP0191-0286-0445-BSHH |
| 19.050 (0.750") +0.025/+0.051 (mm) | 28.575 +0.076/+0.102 | 50.800 +/-0.190 | BP0191-0286-0508-BSTH |
| 19.050 (0.750") +0.051/+0.076 (mm) | 28.575 +0.051/+0.076 | 50.800 +/-0.190 | BP0191-0286-0508-BSHH |
| 19.050 (0.750") +0.025/+0.051 (mm) | 31.750 +0.076/+0.102 | 19.050 +/-0.127 | BP0191-0318-0191-BSTH |
| 19.050 (0.750") +0.051/+0.076 (mm) | 31.750 +0.051/+0.076 | 19.050 +/-0.127 | BP0191-0318-0191-BSHH |
| 19.050 (0.750") +0.025/+0.051 (mm) | 31.750 +0.076/+0.102 | 25.400 +/-0.127 | BP0191-0318-0254-BSTH |
| 19.050 (0.750") +0.051/+0.076 (mm) | 31.750 +0.051/+0.076 | 25.400 +/-0.127 | BP0191-0318-0254-BSHH |
| 19.050 (0.750") +0.025/+0.051 (mm) | 31.750 +0.076/+0.102 | 31.750 +/-0.127 | BP0191-0318-0318-BSTH |
| 19.050 (0.750") +0.051/+0.076 (mm) | 31.750 +0.051/+0.076 | 31.750 +/-0.127 | BP0191-0318-0318-BSHH |
| 19.050 (0.750") +0.025/+0.051 (mm) | 31.750 +0.076/+0.102 | 38.100 +/-0.127 | BP0191-0318-0381-BSTH |
| 19.050 (0.750") +0.051/+0.076 (mm) | 31.750 +0.051/+0.076 | 38.100 +/-0.127 | BP0191-0318-0381-BSHH |
| 19.050 (0.750") +0.025/+0.051 (mm) | 31.750 +0.076/+0.102 | 44.450 +/-0.190 | BP0191-0318-0445-BSHH |
| 19.050 (0.750") +0.051/+0.076 (mm) | 31.750 +0.051/+0.076 | 50.800 +/-0.190 | BP0191-0318-0508-BSHH |
| 20.000 (0.787") +0.005/+0.030 (mm) | 23.000 +0.036/+0.061 | 24.000 +/-0.120 | BP0200-0230-0240-BSLT |
| 20.000 (0.787") +0.005/+0.030 (mm) | 24.000 +0.036/+0.061 | 16.000 +/-0.120 | BP0200-0240-0160-BSLT |
| 20.000 (0.787") +0.005/+0.030 (mm) | 24.000 +0.036/+0.061 | 20.000 +/-0.127 | BP0200-0240-0200-BSLT |
| 20.000 (0.787") +0.005/+0.030 (mm) | 24.000 +0.036/+0.061 | 24.000 +/-0.120 | BP0200-0240-0240-BSLT |
| 20.000 (0.787") +0.005/+0.030 (mm) | 24.000 +0.036/+0.061 | 25.000 +/-0.127 | BP0200-0240-0250-BSLT |
| 20.000 (0.787") +0.005/+0.030 (mm) | 24.000 +0.036/+0.061 | 27.000 +/-0.120 | BP0200-0240-0270-BSLT |
| 20.000 (0.787") +0.005/+0.030 (mm) | 24.000 +0.036/+0.061 | 30.000 +/-0.120 | BP0200-0240-0300-BSLT |
| 20.000 (0.787") +0.005/+0.030 (mm) | 24.000 +0.036/+0.061 | 32.000 +/-0.120 | BP0200-0240-0320-BSLT |



Stocked or Short Delivery



Usually Available Short Delivery



Long delivery or not in current production

* Large Minimum Quantities

** Available only while stock lasts

Bushes - Plain

| Nominal ID (d) mm (inches) | Nominal OD (D) mm | Length (S) mm | Part Number |
|---------------------------------------|-------------------------|--------------------|-------------------------------|
| 20.000 (0.787") +0.005/+0.030 (mm) | 25.000 +0.036/+0.061 | 15.000 +/-0.120 | BP0200-0250-0150-BSLT |
| 20.000 (0.787") +0.005/+0.030 (mm) | 25.000 +0.036/+0.061 | 16.000 +/-0.120 | BP0200-0250-0160-BSLT |
| 20.000 (0.787") +0.005/+0.030 (mm) | 25.000 +0.036/+0.061 | 20.000 +/-0.120 | BP0200-0250-0200-BSLT |
| 20.000 (0.787") +0.005/+0.030 (mm) | 25.000 +0.036/+0.061 | 22.000 +/-0.120 | BP0200-0250-0220-BSLT |
| 20.000 (0.787") +0.005/+0.030 (mm) | 25.000 +0.036/+0.061 | 25.000 +/-0.120 | BP0200-0250-0250-BSLT |
| 20.000 (0.787") +0.005/+0.030 (mm) | 25.000 +0.036/+0.061 | 28.000 +/-0.120 | BP0200-0250-0280-BSLT |
| 20.000 (0.787") +0.005/+0.030 (mm) | 25.000 +0.036/+0.061 | 30.000 +/-0.120 | BP0200-0250-0300-BSLT |
| 20.000 (0.787") +0.005/+0.030 (mm) | 25.000 +0.036/+0.061 | 32.000 +/-0.120 | BP0200-0250-0320-BSLT |
| 20.000 (0.787") +0.005/+0.030 (mm) | 26.000 +0.036/+0.061 | 15.000 +/-0.127 | BP0200-0260-0150-BSLT |
| 20.000 (0.787") +0.005/+0.030 (mm) | 26.000 +0.036/+0.061 | 16.000 +/-0.120 | BP0200-0260-0160-BSLT |
| 20.000 (0.787") +0.005/+0.030 (mm) | 26.000 +0.036/+0.061 | 20.000 +/-0.127 | BP0200-0260-0200-BSLT |
| 20.000 (0.787") +0.005/+0.030 (mm) | 26.000 +0.036/+0.061 | 25.000 +/-0.127 | BP0200-0260-0250-BSLT |
| 20.000 (0.787") +0.005/+0.030 (mm) | 26.000 +0.036/+0.061 | 32.000 +/-0.120 | BP0200-0260-0320-BSLT |
| 20.000 (0.787") +0.005/+0.030 (mm) | 27.000 +0.036/+0.061 | 16.000 +/-0.120 | BP0200-0270-0160-BSLT |
| 20.000 (0.787") +0.005/+0.030 (mm) | 27.000 +0.036/+0.061 | 20.000 +/-0.120 | BP0200-0270-0200-BSLT |
| 20.000 (0.787") +0.005/+0.030 (mm) | 27.000 +0.036/+0.061 | 25.000 +/-0.120 | BP0200-0270-0250-BSLT |
| 20.000 (0.787") +0.005/+0.030 (mm) | 27.000 +0.036/+0.061 | 32.000 +/-0.120 | BP0200-0270-0320-BSLT |
| 20.000 (0.787") +0.005/+0.030 (mm) | 28.000 +0.036/+0.061 | 16.000 +/-0.120 | BP0200-0280-0160-BSLT |
| 20.000 (0.787") +0.005/+0.030 (mm) | 28.000 +0.036/+0.061 | 20.000 +/-0.120 | BP0200-0280-0200-BSLT |
| 20.000 (0.787") +0.005/+0.030 (mm) | 28.000 +0.036/+0.061 | 25.000 +/-0.120 | BP0200-0280-0250-BSLT |
| 20.000 (0.787") +0.005/+0.030 (mm) | 28.000 +0.036/+0.061 | 28.000 +/-0.120 | BP0200-0280-0280-BSLT |
| 20.000 (0.787") +0.005/+0.030 (mm) | 28.000 +0.036/+0.061 | 30.000 +/-0.120 | BP0200-0280-0300-BSLT |
| 20.000 (0.787") +0.005/+0.030 (mm) | 28.000 +0.036/+0.061 | 32.000 +/-0.120 | BP0200-0280-0320-BSLT |
| 20.000 (0.787") +0.005/+0.030 (mm) | 30.000 +0.036/+0.061 | 25.000 +/-0.127 | BP0200-0300-0250-BSLT |
| 20.638 (0.813") +0.025/+0.051 (mm) | 25.400 +0.076/+0.102 | 19.050 +/-0.127 | BP0206-0254-0191-BSTH1 |
| 20.638 (0.813") +0.038/+0.064 (mm) | 25.400 +0.051/+0.076 | 19.050 +/-0.127 | BP0206-0254-0191-BSTH2 |
| 20.638 (0.813") +0.051/+0.076 (mm) | 25.400 -0.025/+0.000 | 19.050 +/-0.127 | BP0206-0254-0191-BSHU |
| 20.638 (0.813") +0.025/+0.051 (mm) | 25.400 +0.051/+0.076 | 22.225 +/-0.127 | BP0207-0254-0222-BSTH |
| 20.638 (0.813") +0.000/+0.025 (mm) | 25.400 +0.051/+0.076 | 25.400 +/-0.127 | BP0206-0254-0254-BSLH |
| 20.638 (0.813") +0.025/+0.051 (mm) | 25.400 +0.051/+0.076 | 25.400 +/-0.127 | BP0206-0254-0254-BSTH1 |
| 20.638 (0.813") +0.025/+0.051 (mm) | 25.400 +0.076/+0.102 | 25.400 +/-0.127 | BP0206-0254-0254-BSTH2 |
| 20.638 (0.813") +0.038/+0.064 (mm) | 25.400 +0.051/+0.076 | 25.400 +/-0.127 | BP0206-0254-0254-BSTH3 |
| 20.638 (0.813") +0.051/+0.076 (mm) | 25.400 -0.025/+0.000 | 25.400 +/-0.127 | BP0206-0254-0254-BSHU |
| 20.638 (0.813") +0.000/+0.025 (mm) | 25.400 +0.051/+0.076 | 31.750 +/-0.127 | BP0206-0254-0318-BSLH |



Stocked or Short Delivery



Usually Available Short Delivery



Long delivery or not in current production

* Large Minimum Quantities

** Available only while stock lasts

Bushes - Plain

| Nominal ID (d) mm (inches) | Nominal OD (D) mm | Length (S) mm | Part Number |
|---------------------------------------|-------------------------|--------------------|-------------------------------|
| 20.638 (0.813") +0.025/+0.051 (mm) | 25.400 +0.051/+0.076 | 31.750 +/-0.127 | BP0206-0254-0318-BSTH1 |
| 20.638 (0.813") +0.025/+0.051 (mm) | 25.400 +0.076/+0.102 | 31.750 +/-0.127 | BP0206-0254-0318-BSTH2 |
| 20.638 (0.813") +0.038/+0.064 (mm) | 25.400 +0.051/+0.076 | 31.750 +/-0.127 | BP0206-0254-0318-BSTH3 |
| 20.638 (0.813") +0.051/+0.076 (mm) | 25.400 -0.025/+0.000 | 31.750 +/-0.127 | BP0206-0254-0318-BSHU |
| 20.638 (0.813") +0.025/+0.051 (mm) | 25.400 +0.076/+0.102 | 38.100 +/-0.127 | BP0206-0254-0381-BSTH1 |
| 20.638 (0.813") +0.038/+0.064 (mm) | 25.400 +0.051/+0.076 | 38.100 +/-0.127 | BP0206-0254-0381-BSTH2 |
| 20.638 (0.813") +0.051/+0.076 (mm) | 25.400 -0.025/+0.000 | 38.100 +/-0.127 | BP0206-0254-0381-BSHU |
| 20.638 (0.813") +0.000/+0.025 (mm) | 25.400 +0.051/+0.076 | 44.450 | BP0206-0254-0445-BSLH |
| 20.638 (0.813") +0.025/+0.051 (mm) | 25.400 +0.076/+0.102 | 44.450 +/-0.190 | BP0206-0254-0445-BSTH1 |
| 20.638 (0.813") +0.038/+0.064 (mm) | 25.400 +0.051/+0.076 | 44.450 +/-0.190 | BP0206-0254-0445-BSTH2 |
| 20.638 (0.813") +0.051/+0.076 (mm) | 25.400 -0.025/+0.000 | 44.450 +/-0.190 | BP0206-0254-0445-BSHU |
| 20.638 (0.813") +0.038/+0.064 (mm) | 25.400 +0.051/+0.076 | 50.800 +/-0.190 | BP0206-0254-0508-BSTH |
| 20.638 (0.813") +0.051/+0.076 (mm) | 25.400 -0.025/+0.000 | 50.800 +/-0.190 | BP0206-0254-0508-BSHU |
| 20.638 (0.813") +0.038/+0.064 (mm) | 26.988 +0.038/+0.064 | 25.400 +/-0.127 | BP0206-0270-0254-BSTT |
| 20.638 (0.813") +0.038/+0.064 (mm) | 26.988 +0.038/+0.064 | 31.750 +/-0.127 | BP0206-0270-0318-BSTT |
| 22.000 (0.866") +0.005/+0.030 (mm) | 27.000 +0.036/+0.061 | 15.000 +/-0.120 | BP0220-0270-0150-BSLT |
| 22.000 (0.866") +0.005/+0.030 (mm) | 27.000 +0.036/+0.061 | 18.000 +/-0.120 | BP0220-0270-0180-BSLT |
| 22.000 (0.866") +0.005/+0.030 (mm) | 27.000 +0.036/+0.061 | 20.000 +/-0.120 | BP0220-0270-0200-BSLT |
| 22.000 (0.866") +0.005/+0.030 (mm) | 27.000 +0.036/+0.061 | 22.000 +/-0.120 | BP0220-0270-0220-BSLT |
| 22.000 (0.866") +0.005/+0.030 (mm) | 27.000 +0.036/+0.061 | 25.000 +/-0.120 | BP0220-0270-0250-BSLT |
| 22.000 (0.866") +0.005/+0.030 (mm) | 27.000 +0.036/+0.061 | 28.000 +/-0.120 | BP0220-0270-0280-BSLT |
| 22.000 (0.866") +0.005/+0.030 (mm) | 27.000 +0.036/+0.061 | 36.000 +/-0.120 | BP0220-0270-0360-BSLT |
| 22.000 (0.866") +0.005/+0.030 (mm) | 28.000 +0.036/+0.061 | 18.000 +/-0.120 | BP0220-0280-0180-BSLT |
| 22.000 (0.866") +0.005/+0.030 (mm) | 28.000 +0.036/+0.061 | 20.000 +/-0.127 | BP0220-0280-0200-BSLT |
| 22.000 (0.866") +0.005/+0.030 (mm) | 28.000 +0.036/+0.061 | 22.000 +/-0.120 | BP0220-0280-0220-BSLT |
| 22.000 (0.866") +0.005/+0.030 (mm) | 28.000 +0.036/+0.061 | 28.000 +/-0.120 | BP0220-0280-0280-BSLT |
| 22.000 (0.866") +0.005/+0.030 (mm) | 28.000 +0.036/+0.061 | 30.000 +/-0.127 | BP0220-0280-0300-BSLT |
| 22.000 (0.866") +0.005/+0.030 (mm) | 28.000 +0.036/+0.061 | 36.000 +/-0.120 | BP0220-0280-0360-BSLT |
| 22.000 (0.866") +0.005/+0.030 (mm) | 29.000 +0.036/+0.061 | 18.000 +/-0.120 | BP0220-0290-0180-BSLT |
| 22.000 (0.866") +0.005/+0.030 (mm) | 29.000 +0.036/+0.061 | 22.000 +/-0.120 | BP0220-0290-0220-BSLT |
| 22.000 (0.866") +0.005/+0.030 (mm) | 29.000 +0.036/+0.061 | 28.000 +/-0.120 | BP0220-0290-0280-BSLT |
| 22.000 (0.866") +0.005/+0.030 (mm) | 29.000 +0.036/+0.061 | 36.000 +/-0.120 | BP0220-0290-0360-BSLT |
| 22.225 (0.875") +0.000/+0.025 (mm) | 25.400 +0.051/+0.076 | 9.525 +/-0.127 | BP0222-0254-0095-BSLH |
| 22.225 (0.875") +0.025/+0.051 (mm) | 25.400 +0.076/+0.102 | 9.525 +/-0.127 | BP0222-0254-0095-BSTH |



Stocked or Short Delivery



Usually Available Short Delivery



Long delivery or not in current production

* Large Minimum Quantities

** Available only while stock lasts

Bushes - Plain

| Nominal ID (d) mm (inches) | Nominal OD (D) mm | Length (S) mm | Part Number |
|---------------------------------------|-------------------------|--------------------|------------------------------|
| 22.225 (0.875") +0.000/+0.025 (mm) | 25.400 +0.051/+0.076 | 11.113 +/-0.127 | BP0222-0254-0111-BSLH |
| 22.225 (0.875") +0.000/+0.025 (mm) | 25.400 +0.051/+0.076 | 12.700 +/-0.127 | BP0222-0254-0127-BSLH |
| 22.225 (0.875") +0.025/+0.051 (mm) | 25.400 +0.076/+0.102 | 12.700 +/-0.127 | BP0222-0254-0127-BSTH |
| 22.225 (0.875") +0.051/+0.076 (mm) | 25.400 +0.051/+0.076 | 12.700 +/-0.127 | BP0222-0254-0127-BSHH |
| 22.225 (0.875") +0.000/+0.025 (mm) | 25.400 +0.051/+0.076 | 15.875 +/-0.127 | BP0222-0254-0159-BSLH |
| 22.225 (0.875") +0.025/+0.051 (mm) | 25.400 +0.051/+0.076 | 15.875 +/-0.127 | BP0222-0254-0159-BSTH1 |
| 22.225 (0.875") +0.025/+0.051 (mm) | 25.400 +0.076/+0.102 | 15.875 +/-0.127 | BP0222-0254-0159-BSTH2 |
| 22.225 (0.875") +0.000/+0.025 (mm) | 25.400 +0.051/+0.076 | 19.050 +/-0.127 | BP0222-0254-0191-BSLH |
| 22.225 (0.875") +0.025/+0.051 (mm) | 25.400 +0.051/+0.076 | 19.050 +/-0.127 | BP0222-0254-0191-BSTH1 |
| 22.225 (0.875") +0.025/+0.051 (mm) | 25.400 +0.076/+0.102 | 19.050 +/-0.127 | BP0222-0254-0191-BSTH2 |
| 22.225 (0.875") +0.051/+0.076 (mm) | 25.400 +0.051/+0.076 | 19.050 +/-0.127 | BP0222-0254-0191-BSHH |
| 22.225 (0.875") +0.025/+0.051 (mm) | 25.400 +0.076/+0.102 | 22.225 +/-0.127 | BP0222-0254-0223-BSTH |
| 22.225 (0.875") +0.051/+0.076 (mm) | 25.400 +0.051/+0.076 | 22.225 +/-0.127 | BP0222-0254-0223-BSHH |
| 22.225 (0.875") +0.000/+0.025 (mm) | 25.400 +0.051/+0.076 | 25.400 +/-0.127 | BP0222-0254-0254-BSLH |
| 22.225 (0.875") +0.025/+0.051 (mm) | 25.400 +0.076/+0.102 | 25.400 +/-0.127 | BP0222-0254-0254-BSTH |
| 22.225 (0.875") +0.051/+0.076 (mm) | 25.400 +0.051/+0.076 | 25.400 +/-0.127 | BP0222-0254-0254-BSHH |
| 22.225 (0.875") +0.025/+0.051 (mm) | 25.400 +0.051/+0.076 | 28.575 +/-0.127 | BP0222-0254-0286-BSTH |
| 22.225 (0.875") +0.000/+0.025 (mm) | 25.400 +0.051/+0.076 | 31.750 +/-0.127 | BP0222-0254-0318-BSLH |
| 22.225 (0.875") +0.025/+0.051 (mm) | 25.400 +0.051/+0.076 | 31.750 +/-0.127 | BP0222-0254-0318-BSTH2 |
| 22.225 (0.875") +0.025/+0.051 (mm) | 25.400 +0.051/+0.076 | 31.750 +/-0.127 | BP0222-0254-0318-BSTH1 |
| 22.225 (0.875") +0.025/+0.051 (mm) | 25.400 +0.076/+0.102 | 31.750 +/-0.127 | BP0222-0254-0318-BSTH3 |
| 22.225 (0.875") +0.051/+0.076 (mm) | 25.400 +0.051/+0.076 | 31.750 +/-0.127 | BP0222-0254-0318-BSHH |
| 22.225 (0.875") +0.000/+0.025 (mm) | 25.400 +0.051/+0.076 | 38.100 +/-0.127 | BP0222-0254-0381-BSLH |
| 22.225 (0.875") +0.025/+0.051 (mm) | 25.400 +0.076/+0.102 | 38.100 +/-0.127 | BP0222-0254-0381-BSTH |
| 22.225 (0.875") +0.051/+0.076 (mm) | 25.400 +0.051/+0.076 | 38.100 +/-0.127 | BP0222-0254-0381-BSHH |
| 22.225 (0.875") +0.000/+0.025 (mm) | 25.400 +0.051/+0.076 | 44.450 +/-0.190 | BP0222-0254-0445-BSLH |
| 22.225 (0.875") +0.025/+0.051 (mm) | 25.400 +0.076/+0.102 | 44.450 +/-0.190 | BP0222-0254-0445-BSTH |
| 22.225 (0.875") +0.051/+0.076 (mm) | 25.400 +0.051/+0.076 | 44.450 +/-0.190 | BP0222-0254-0445-BSHH |
| 22.225 (0.875") +0.025/+0.051 (mm) | 26.988 +0.038/+0.064 | 19.050 +/-0.127 | BP0222-0270-0191-BSTT |
| 22.225 (0.875") +0.051/+0.076 (mm) | 26.988 +0.051/+0.076 | 25.400 +/-0.127 | BP0222-0270-0254-BSHH |
| 22.225 (0.875") +0.025/+0.051 (mm) | 26.988 +0.038/+0.064 | 31.750 | BP0222-0270-0318-BSTT |
| 22.225 (0.875") +0.051/+0.076 (mm) | 26.988 +0.051/+0.076 | 31.750 +/-0.127 | BP0222-0270-0318-BSHH |
| 22.225 (0.875") +0.051/+0.076 (mm) | 26.988 +0.051/+0.076 | 38.100 +/-0.127 | BP0222-0270-0381-BSHH |
| 22.225 (0.875") +0.000/+0.025 (mm) | 28.575 +0.051/+0.076 | 19.050 | BP0222-0286-0191-BSLH |



Stocked or Short Delivery



Usually Available Short Delivery



Long delivery or not in current production

* Large Minimum Quantities

** Available only while stock lasts

Bushes - Plain

| Nominal ID (d) mm (inches) | Nominal OD (D) mm | Length (S) mm | Part Number |
|---------------------------------------|-------------------------|--------------------|------------------------------|
| 22.225 (0.875") +0.025/+0.051 (mm) | 28.575 +0.076/+0.102 | 19.050 +/-0.127 | BP0222-0286-0191-BSTH |
| 22.225 (0.875") +0.051/+0.076 (mm) | 28.575 +0.051/+0.076 | 19.050 +/-0.127 | BP0222-0286-0191-BSHH |
| 22.225 (0.875") +0.000/+0.025 (mm) | 28.575 +0.051/+0.076 | 22.225 | BP0222-0286-0223-BSLH |
| 22.225 (0.875") +0.025/+0.051 (mm) | 28.575 +0.076/+0.102 | 22.225 +/-0.127 | BP0222-0286-0222-BSTH |
| 22.225 (0.875") +0.051/+0.076 (mm) | 28.575 +0.051/+0.076 | 22.225 +/-0.127 | BP0222-0286-0223-BSHH |
| 22.225 (0.875") +0.000/+0.025 (mm) | 28.575 +0.051/+0.076 | 25.400 +/-0.127 | BP0222-0286-0254-BSLH |
| 22.225 (0.875") +0.025/+0.051 (mm) | 28.575 +0.076/+0.102 | 25.400 +/-0.127 | BP0222-0286-0254-BSTH |
| 22.225 (0.875") +0.051/+0.076 (mm) | 28.575 +0.038/+0.064 | 25.400 +/-0.127 | BP0222-0286-0254-BSHT |
| 22.225 (0.875") +0.051/+0.076 (mm) | 28.575 +0.051/+0.076 | 25.400 +/-0.127 | BP0222-0286-0254-BSHH |
| 22.225 (0.875") +0.000/+0.025 (mm) | 28.575 +0.051/+0.076 | 28.575 | BP0222-0286-0286-BSLH |
| 22.225 (0.875") +0.025/+0.051 (mm) | 28.575 +0.076/+0.102 | 28.575 +/-0.127 | BP0222-0286-0286-BSTH |
| 22.225 (0.875") +0.051/+0.076 (mm) | 28.575 +0.051/+0.076 | 28.575 +/-0.127 | BP0222-0286-0286-BSHH |
| 22.225 (0.875") +0.000/+0.025 (mm) | 28.575 +0.051/+0.076 | 31.750 +/-0.127 | BP0222-0286-0318-BSLH |
| 22.225 (0.875") +0.025/+0.051 (mm) | 28.575 +0.076/+0.102 | 31.750 +/-0.127 | BP0222-0286-0318-BSTH |
| 22.225 (0.875") +0.051/+0.076 (mm) | 28.575 +0.038/+0.064 | 31.750 +/-0.127 | BP0222-0286-0318-BSHT |
| 22.225 (0.875") +0.051/+0.076 (mm) | 28.575 +0.051/+0.076 | 31.750 +/-0.127 | BP0222-0286-0318-BSHH |
| 22.225 (0.875") +0.000/+0.025 (mm) | 28.575 +0.051/+0.076 | 34.925 +/-0.127 | BP0222-0286-0349-BSLH |
| 22.225 (0.875") +0.025/+0.051 (mm) | 28.575 +0.076/+0.102 | 34.925 +/-0.127 | BP0222-0286-0349-BSTH |
| 22.225 (0.875") +0.051/+0.076 (mm) | 28.575 +0.038/+0.064 | 34.925 +/-0.127 | BP0222-0286-0349-BSHT |
| 22.225 (0.875") +0.051/+0.076 (mm) | 28.575 +0.051/+0.076 | 34.925 +/-0.127 | BP0222-0286-0349-BSHH |
| 22.225 (0.875") +0.000/+0.025 (mm) | 28.575 +0.051/+0.076 | 38.100 +/-0.127 | BP0222-0286-0381-BSLH |
| 22.225 (0.875") +0.025/+0.051 (mm) | 28.575 +0.076/+0.102 | 38.100 +/-0.127 | BP0222-0286-0381-BSTH |
| 22.225 (0.875") +0.051/+0.076 (mm) | 28.575 +0.038/+0.064 | 38.100 +/-0.127 | BP0222-0286-0381-BSHT |
| 22.225 (0.875") +0.051/+0.076 (mm) | 28.575 +0.051/+0.076 | 38.100 +/-0.127 | BP0222-0286-0381-BSHH |
| 22.225 (0.875") +0.025/+0.051 (mm) | 28.575 +0.076/+0.102 | 41.275 +/-0.190 | BP0222-0286-0413-BSTH |
| 22.225 (0.875") +0.051/+0.076 (mm) | 28.575 +0.051/+0.076 | 41.275 +/-0.190 | BP0222-0286-0413-BSHH |
| 22.225 (0.875") +0.000/+0.025 (mm) | 28.575 +0.051/+0.076 | 44.450 | BP0222-0286-0445-BSLH |
| 22.225 (0.875") +0.025/+0.051 (mm) | 28.575 +0.076/+0.102 | 44.450 +/-0.190 | BP0222-0286-0445-BSTH |
| 22.225 (0.875") +0.051/+0.076 (mm) | 28.575 +0.051/+0.076 | 44.450 +/-0.190 | BP0222-0286-0445-BSHH |
| 22.225 (0.875") +0.000/+0.025 (mm) | 28.575 +0.051/+0.076 | 50.800 | BP0222-0286-0508-BSLH |
| 22.225 (0.875") +0.025/+0.051 (mm) | 28.575 +0.076/+0.102 | 50.800 +/-0.190 | BP0222-0286-0508-BSTH |
| 22.225 (0.875") +0.051/+0.076 (mm) | 28.575 +0.051/+0.076 | 50.800 +/-0.190 | BP0222-0286-0508-BSHH |
| 22.225 (0.875") +0.000/+0.025 (mm) | 28.575 +0.051/+0.076 | 57.150 | BP0222-0286-0572-BSLH |
| 22.225 (0.875") +0.025/+0.051 (mm) | 28.575 +0.076/+0.102 | 57.150 +/-0.190 | BP0222-0286-0572-BSTH |

Stocked or Short Delivery
 Usually Available Short Delivery
 Long delivery or not in current production

* Large Minimum Quantities

** Available only while stock lasts

Bushes - Plain

| Nominal ID (d) mm (inches) | Nominal OD (D) mm | Length (S) mm | Part Number |
|---------------------------------------|-------------------------|--------------------|------------------------------|
| 22.225 (0.875") +0.051/+0.076 (mm) | 28.575 +0.051/+0.076 | 57.150 +/-0.190 | BP0222-0286-0572-BSHH |
| 22.225 (0.875") +0.000/+0.025 (mm) | 28.575 +0.051/+0.076 | 63.500 | BP0222-0286-0635-BSLH |
| 22.225 (0.875") +0.025/+0.051 (mm) | 28.575 +0.076/+0.102 | 63.500 +/-0.190 | BP0222-0286-0635-BSTH |
| 22.225 (0.875") +0.051/+0.076 (mm) | 28.575 +0.051/+0.076 | 63.500 +/-0.190 | BP0222-0286-0635-BSHH |
| 22.225 (0.875") +0.000/+0.025 (mm) | 28.575 +0.051/+0.076 | 69.850 +/-0.190 | BP0222-0286-0699-BSLH |
| 22.225 (0.875") +0.025/+0.051 (mm) | 31.750 +0.076/+0.102 | 19.050 +/-0.127 | BP0222-0318-0191-BSTH |
| 22.225 (0.875") +0.051/+0.076 (mm) | 31.750 +0.051/+0.076 | 19.050 +/-0.127 | BP0222-0318-0191-BSHH |
| 22.225 (0.875") +0.025/+0.051 (mm) | 31.750 +0.025/+0.051 | 25.400 | BP0222-0318-0254-BSTT |
| 22.225 (0.875") +0.025/+0.051 (mm) | 31.750 +0.076/+0.102 | 25.400 +/-0.127 | BP0222-0318-0254-BSTH |
| 22.225 (0.875") +0.051/+0.076 (mm) | 31.750 +0.051/+0.076 | 25.400 +/-0.127 | BP0222-0318-0254-BSHH |
| 22.225 (0.875") +0.025/+0.051 (mm) | 31.750 +0.025/+0.051 | 31.750 | BP0222-0318-0318-BSTT |
| 22.225 (0.875") +0.025/+0.051 (mm) | 31.750 +0.076/+0.102 | 31.750 +/-0.127 | BP0222-0318-0318-BSTH |
| 22.225 (0.875") +0.051/+0.076 (mm) | 31.750 +0.051/+0.076 | 31.750 +/-0.127 | BP0222-0318-0318-BSHH |
| 22.225 (0.875") +0.051/+0.076 (mm) | 31.750 +0.051/+0.076 | 34.925 +/-0.127 | BP0222-0318-0349-BSHH |
| 22.225 (0.875") +0.025/+0.051 (mm) | 31.750 +0.025/+0.051 | 38.100 | BP0222-0318-0381-BSTT |
| 22.225 (0.875") +0.025/+0.051 (mm) | 31.750 +0.076/+0.102 | 38.100 +/-0.127 | BP0222-0318-0381-BSTH |
| 22.225 (0.875") +0.051/+0.076 (mm) | 31.750 +0.051/+0.076 | 38.100 +/-0.127 | BP0222-0318-0381-BSHH |
| 22.225 (0.875") +0.025/+0.051 (mm) | 31.750 +0.076/+0.102 | 50.800 +/-0.190 | BP0222-0318-0508-BSTH |
| 22.225 (0.875") +0.051/+0.076 (mm) | 31.750 +0.051/+0.076 | 50.800 +/-0.190 | BP0222-0318-0508-BSHH |
| 23.813 (0.938") +0.038/+0.064 (mm) | 26.988 +0.038/+0.064 | 19.050 +/-0.127 | BP0238-0270-0191-BSTT |
| 23.813 (0.938") +0.038/+0.064 (mm) | 26.988 +0.038/+0.064 | 31.750 +/-0.127 | BP0238-0270-0318-BSTT |
| 23.813 (0.938") +0.025/+0.051 (mm) | 30.163 +0.076/+0.102 | 19.050 +/-0.127 | BP0238-0302-0191-BSTH |
| 23.813 (0.938") +0.038/+0.064 (mm) | 30.163 +0.038/+0.064 | 19.050 +/-0.127 | BP0238-0302-0191-BSTT |
| 23.813 (0.938") +0.051/+0.076 (mm) | 30.163 +0.051/+0.076 | 19.050 +/-0.127 | BP0238-0302-0191-BSHH |
| 23.813 (0.938") +0.013/+0.038 (mm) | 30.163 +0.025/+0.051 | 22.225 +/-0.127 | BP0238-0302-0222-BSLT |
| 23.813 (0.938") +0.013/+0.038 (mm) | 30.163 +0.025/+0.051 | 25.400 +/-0.127 | BP0238-0302-0254-BSLT |
| 23.813 (0.938") +0.025/+0.051 (mm) | 30.163 +0.076/+0.102 | 25.400 +/-0.127 | BP0238-0302-0254-BSTH |
| 23.813 (0.938") +0.038/+0.064 (mm) | 30.163 +0.038/+0.064 | 25.400 +/-0.127 | BP0238-0302-0254-BSTT |
| 23.813 (0.938") +0.051/+0.076 (mm) | 30.163 +0.051/+0.076 | 25.400 +/-0.127 | BP0238-0302-0254-BSHH |
| 23.813 (0.938") +0.013/+0.038 (mm) | 30.163 +0.025/+0.051 | 31.750 +/-0.127 | BP0238-0302-0318-BSLT |
| 23.813 (0.938") +0.025/+0.051 (mm) | 30.163 +0.076/+0.102 | 31.750 +/-0.127 | BP0238-0302-0318-BSTH |
| 23.813 (0.938") +0.038/+0.064 (mm) | 30.163 +0.038/+0.064 | 31.750 +/-0.127 | BP0238-0302-0318-BSTT |
| 23.813 (0.938") +0.051/+0.076 (mm) | 30.163 +0.051/+0.076 | 31.750 +/-0.127 | BP0238-0302-0318-BSHH |
| 23.813 (0.938") +0.013/+0.038 (mm) | 30.163 +0.025/+0.051 | 38.100 +/-0.127 | BP0238-0302-0381-BSLT |

Stocked or Short Delivery
 Usually Available Short Delivery
 Long delivery or not in current production

* Large Minimum Quantities

** Available only while stock lasts

Bushes - Plain

| Nominal ID (d) mm (inches) | Nominal OD (D) mm | Length (S) mm | Part Number |
|---------------------------------------|-------------------------|--------------------|-------------------------------|
| 23.813 (0.938") +0.025/+0.051 (mm) | 30.163 +0.076/+0.102 | 38.100 +/-0.127 | BP0238-0302-0381-BSTH |
| 23.813 (0.938") +0.038/+0.064 (mm) | 30.163 +0.038/+0.064 | 38.100 +/-0.127 | BP0238-0302-0381-BSTT |
| 23.813 (0.938") +0.051/+0.076 (mm) | 30.163 +0.051/+0.076 | 38.100 +/-0.127 | BP0238-0302-0381-BSHH |
| 23.813 (0.938") +0.025/+0.051 (mm) | 30.163 +0.076/+0.102 | 50.800 +/-0.190 | BP0238-0302-0508-BSTH |
| 23.813 (0.938") +0.038/+0.064 (mm) | 30.163 +0.038/+0.064 | 50.800 +/-0.190 | BP0238-0302-0508-BSTT |
| 23.813 (0.938") +0.051/+0.076 (mm) | 30.163 +0.051/+0.076 | 50.800 +/-0.190 | BP0238-0302-0508-BSHH |
| 23.813 (0.938") +0.025/+0.051 (mm) | 31.750 +0.076/+0.102 | 19.050 +/-0.127 | BP0238-0318-0191-BSTH1 |
| 23.813 (0.938") +0.038/+0.064 (mm) | 31.750 +0.076/+0.102 | 19.050 +/-0.127 | BP0238-0318-0191-BSTH2 |
| 23.813 (0.938") +0.051/+0.076 (mm) | 31.750 +0.051/+0.076 | 19.050 +/-0.127 | BP0238-0318-0191-BSHH |
| 23.813 (0.938") +0.025/+0.051 (mm) | 31.750 +0.076/+0.102 | 25.400 +/-0.127 | BP0238-0318-0254-BSTH1 |
| 23.813 (0.938") +0.038/+0.064 (mm) | 31.750 +0.076/+0.102 | 25.400 +/-0.127 | BP0238-0318-0254-BSTH2 |
| 23.813 (0.938") +0.051/+0.076 (mm) | 31.750 +0.051/+0.076 | 25.400 +/-0.127 | BP0238-0318-0254-BSHH |
| 23.813 (0.938") -0.025/+0.000 (mm) | 31.750 +0.051/+0.076 | 25.400 +/-0.127 | BP0238-0318-0254-BSUH |
| 23.813 (0.938") +0.025/+0.051 (mm) | 31.750 +0.076/+0.102 | 31.750 +/-0.127 | BP0238-0318-0318-BSTH1 |
| 23.813 (0.938") +0.038/+0.064 (mm) | 31.750 +0.076/+0.102 | 31.750 +/-0.127 | BP0238-0318-0318-BSTH2 |
| 23.813 (0.938") +0.051/+0.076 (mm) | 31.750 +0.051/+0.076 | 31.750 +/-0.127 | BP0238-0318-0318-BSHH |
| 23.813 (0.938") -0.025/+0.000 (mm) | 31.750 +0.051/+0.076 | 31.750 +/-0.127 | BP0238-0318-0318-BSUH |
| 23.813 (0.938") +0.025/+0.051 (mm) | 31.750 +0.076/+0.102 | 38.100 +/-0.127 | BP0238-0318-0381-BSTH1 |
| 23.813 (0.938") +0.038/+0.064 (mm) | 31.750 +0.076/+0.102 | 38.100 +/-0.127 | BP0238-0318-0381-BSTH2 |
| 23.813 (0.938") +0.051/+0.076 (mm) | 31.750 +0.051/+0.076 | 38.100 +/-0.127 | BP0238-0318-0381-BSHH |
| 23.813 (0.938") -0.025/+0.000 (mm) | 31.750 +0.051/+0.076 | 38.100 +/-0.127 | BP0238-0318-0381-BSUH |
| 23.813 (0.938") +0.025/+0.051 (mm) | 31.750 +0.076/+0.102 | 44.450 +/-0.190 | BP0238-0318-0445-BSTH1 |
| 23.813 (0.938") +0.038/+0.064 (mm) | 31.750 +0.076/+0.102 | 44.450 +/-0.190 | BP0238-0318-0445-BSTH2 |
| 23.813 (0.938") +0.051/+0.076 (mm) | 31.750 +0.051/+0.076 | 44.450 +/-0.190 | BP0238-0318-0445-BSHH |
| 23.813 (0.938") +0.025/+0.051 (mm) | 31.750 +0.076/+0.102 | 50.800 +/-0.190 | BP0238-0318-0508-BSTH1 |
| 23.813 (0.938") +0.038/+0.064 (mm) | 31.750 +0.076/+0.102 | 50.800 +/-0.190 | BP0238-0318-0508-BSTH2 |
| 23.813 (0.938") +0.051/+0.076 (mm) | 31.750 +0.051/+0.076 | 50.800 +/-0.190 | BP0238-0318-0508-BSHH |
| 25.000 (0.984") +0.005/+0.030 (mm) | 30.000 +0.036/+0.061 | 25.000 +/-0.127 | BP0250-0300-0250-BSLT |
| 25.000 (0.984") +0.005/+0.030 (mm) | 30.000 +0.036/+0.061 | 28.000 +/-0.120 | BP0250-0300-0280-BSLT |
| 25.000 (0.984") +0.005/+0.030 (mm) | 30.000 +0.036/+0.061 | 30.000 +/-0.160 | BP0250-0300-0300-BSLT |
| 25.000 (0.984") +0.005/+0.030 (mm) | 30.000 +0.036/+0.061 | 32.000 +/-0.120 | BP0250-0300-0320-BSLT |
| 25.000 (0.984") +0.005/+0.030 (mm) | 30.000 +0.036/+0.061 | 35.000 +/-0.120 | BP0250-0300-0350-BSLT |
| 25.000 (0.984") +0.005/+0.030 (mm) | 30.000 +0.036/+0.061 | 40.000 +/-0.190 | BP0250-0300-0400-BSLT |
| 25.000 (0.984") +0.005/+0.030 (mm) | 30.000 +0.036/+0.061 | 45.000 +/-0.190 | BP0250-0300-0450-BSLT |

Stocked or Short Delivery
 Usually Available Short Delivery
 Long delivery or not in current production

* Large Minimum Quantities

** Available only while stock lasts

Bushes - Plain

| Nominal ID (d) mm (inches) | Nominal OD (D) mm | Length (S) mm | Part Number |
|---------------------------------------|-------------------------|--------------------|-------------------------------|
| 25.000 (0.984") +0.005/+0.030 (mm) | 30.000 +0.036/+0.061 | 50.000 +/-0.190 | BP0250-0300-0500-BSLT |
| 25.000 (0.984") +0.005/+0.030 (mm) | 32.000 +0.046/+0.071 | 20.000 +/-0.120 | BP0250-0320-0200-BSLH |
| 25.000 (0.984") +0.005/+0.030 (mm) | 32.000 +0.046/+0.071 | 25.000 +/-0.127 | BP0250-0320-0250-BSLH |
| 25.000 (0.984") +0.005/+0.030 (mm) | 32.000 +0.046/+0.071 | 30.000 +/-0.120 | BP0250-0320-0300-BSLH |
| 25.000 (0.984") +0.005/+0.030 (mm) | 32.000 +0.046/+0.071 | 32.000 +/-0.120 | BP0250-0320-0320-BSLH |
| 25.000 (0.984") +0.005/+0.030 (mm) | 32.000 +0.046/+0.071 | 35.000 +/-0.120 | BP0250-0320-0350-BSLH |
| 25.000 (0.984") +0.005/+0.030 (mm) | 32.000 +0.046/+0.071 | 40.000 +/-0.190 | BP0250-0320-0400-BSLH |
| 25.000 (0.984") +0.005/+0.030 (mm) | 35.000 +0.046/+0.071 | 25.000 +/-0.127 | BP0250-0350-0250-BSLH |
| 25.000 (0.984") +0.005/+0.030 (mm) | 35.000 +0.046/+0.071 | 35.000 +/-0.127 | BP0250-0350-0350-BSLH |
| 25.400 (1.000") +0.000/+0.025 (mm) | 28.575 +0.051/+0.076 | 12.700 +/-0.127 | BP0254-0286-0127-BSLH |
| 25.400 (1.000") +0.000/+0.025 (mm) | 28.575 +0.051/+0.076 | 19.050 +/-0.127 | BP0254-0286-0191-BSLH |
| 25.400 (1.000") +0.051/+0.076 (mm) | 28.575 +0.051/+0.076 | 19.050 +/-0.127 | BP0254-0286-0191-BSHH2 |
| 25.400 (1.000") +0.051/+0.076 (mm) | 28.575 +0.051/+0.076 | 19.050 +/-0.127 | BP0254-0286-0191-BSHH1 |
| 25.400 (1.000") +0.064/+0.089 (mm) | 28.575 +0.051/+0.076 | 19.050 +/-0.127 | BP0254-0286-0191-BSHH3 |
| 25.400 (1.000") +0.076/+0.102 (mm) | 28.575 +0.051/+0.076 | 19.050 +/-0.127 | BP0254-0286-0191-BSHH4 |
| 25.400 (1.000") +0.000/+0.025 (mm) | 28.575 +0.051/+0.076 | 20.638 +/-0.127 | BP0254-0286-0206-BSLH |
| 25.400 (1.000") +0.051/+0.076 (mm) | 28.575 +0.051/+0.076 | 22.225 +/-0.127 | BP0254-0286-0222-BSHH1 |
| 25.400 (1.000") +0.064/+0.089 (mm) | 28.575 +0.051/+0.076 | 22.225 +/-0.127 | BP0254-0286-0222-BSHH2 |
| 25.400 (1.000") +0.000/+0.025 (mm) | 28.575 +0.051/+0.076 | 25.400 +/-0.127 | BP0254-0286-0254-BSLH |
| 25.400 (1.000") +0.051/+0.076 (mm) | 28.575 +0.051/+0.076 | 25.400 +/-0.127 | BP0254-0286-0254-BSHH2 |
| 25.400 (1.000") +0.051/+0.076 (mm) | 28.575 +0.051/+0.076 | 25.400 +/-0.127 | BP0254-0286-0254-BSHH1 |
| 25.400 (1.000") +0.076/+0.102 (mm) | 28.575 +0.051/+0.076 | 25.400 +/-0.127 | BP0254-0286-0254-BSHH3 |
| 25.400 (1.000") +0.000/+0.025 (mm) | 28.575 +0.051/+0.076 | 31.750 +/-0.127 | BP0254-0286-0318-BSLH |
| 25.400 (1.000") +0.051/+0.076 (mm) | 28.575 +0.051/+0.076 | 31.750 +/-0.127 | BP0254-0286-0318-BSHH1 |
| 25.400 (1.000") +0.051/+0.076 (mm) | 28.575 +0.051/+0.076 | 31.750 +/-0.127 | BP0254-0286-0318-BSHH2 |
| 25.400 (1.000") +0.064/+0.089 (mm) | 28.575 +0.051/+0.076 | 31.750 +/-0.127 | BP0254-0286-0318-BSHH3 |
| 25.400 (1.000") +0.076/+0.102 (mm) | 28.575 +0.051/+0.076 | 31.750 +/-0.127 | BP0254-0286-0318-BSHH4 |
| 25.400 (1.000") +0.000/+0.025 (mm) | 28.575 +0.051/+0.076 | 34.925 +/-0.127 | BP0254-0286-0349-BSLH |
| 25.400 (1.000") +0.000/+0.025 (mm) | 28.575 +0.051/+0.076 | 38.100 +/-0.127 | BP0254-0286-0381-BSLH |
| 25.400 (1.000") +0.051/+0.076 (mm) | 28.575 +0.051/+0.076 | 38.100 +/-0.127 | BP0254-0286-0381-BSHH1 |
| 25.400 (1.000") +0.051/+0.076 (mm) | 28.575 +0.051/+0.076 | 38.100 +/-0.127 | BP0254-0286-0381-BSHH2 |
| 25.400 (1.000") +0.064/+0.089 (mm) | 28.575 +0.051/+0.076 | 38.100 +/-0.127 | BP0254-0286-0381-BSHH3 |
| 25.400 (1.000") +0.076/+0.102 (mm) | 28.575 +0.051/+0.076 | 38.100 +/-0.127 | BP0254-0286-0381-BSHH4 |
| 25.400 (1.000") +0.051/+0.076 (mm) | 28.575 +0.051/+0.076 | 44.450 +/-0.190 | BP0254-0286-0445-BSHH2 |



Stocked or Short Delivery



Usually Available Short Delivery



Long delivery or not in current production

* Large Minimum Quantities

** Available only while stock lasts

Bushes - Plain

| Nominal ID (d) mm (inches) | Nominal OD (D) mm | Length (S) mm | Part Number |
|---------------------------------------|-------------------------|--------------------|-------------------------------|
| 25.400 (1.000") +0.051/+0.076 (mm) | 28.575 +0.051/+0.076 | 44.450 +/-0.190 | BP0254-0286-0445-BSHH1 |
| 25.400 (1.000") +0.076/+0.102 (mm) | 28.575 +0.051/+0.076 | 44.450 +/-0.190 | BP0254-0286-0445-BSHH3 |
| 25.400 (1.000") +0.051/+0.076 (mm) | 28.575 +0.051/+0.076 | 50.800 +/-0.190 | BP0254-0286-0508-BSHH2 |
| 25.400 (1.000") +0.051/+0.076 (mm) | 28.575 +0.051/+0.076 | 50.800 +/-0.190 | BP0254-0286-0508-BSHH1 |
| 25.400 (1.000") +0.076/+0.102 (mm) | 28.575 +0.051/+0.076 | 50.800 +/-0.190 | BP0254-0286-0508-BSHH3 |
| 25.400 (1.000") +0.025/+0.051 (mm) | 30.163 +0.025/+0.051 | 19.050 | BP0254-0302-0191-BSTT |
| 25.400 (1.000") +0.051/+0.076 (mm) | 30.163 +0.076/+0.102 | 19.050 +/-0.127 | BP0254-0302-0191-BSHH |
| 25.400 (1.000") +0.076/+0.102 (mm) | 30.163 +0.038/+0.064 | 19.050 +/-0.127 | BP0254-0302-0191-BSHT |
| 25.400 (1.000") +0.025/+0.051 (mm) | 30.163 +0.025/+0.051 | 25.400 | BP0254-0302-0254-BSTT |
| 25.400 (1.000") +0.051/+0.076 (mm) | 30.163 +0.076/+0.102 | 25.400 +/-0.127 | BP0254-0302-0254-BSHH |
| 25.400 (1.000") +0.076/+0.102 (mm) | 30.163 +0.038/+0.064 | 25.400 +/-0.127 | BP0254-0302-0254-BSHT |
| 25.400 (1.000") +0.051/+0.076 (mm) | 30.163 +0.076/+0.102 | 31.750 +/-0.127 | BP0254-0302-0318-BSHH |
| 25.400 (1.000") +0.076/+0.102 (mm) | 30.163 +0.038/+0.064 | 31.750 +/-0.127 | BP0254-0302-0318-BSHT |
| 25.400 (1.000") +0.025/+0.051 (mm) | 30.163 +0.025/+0.051 | 38.100 +/-0.127 | BP0254-0302-0381-BSTT |
| 25.400 (1.000") +0.051/+0.076 (mm) | 30.163 +0.076/+0.102 | 38.100 +/-0.127 | BP0254-0302-0381-BSHH |
| 25.400 (1.000") +0.076/+0.102 (mm) | 30.163 +0.038/+0.064 | 38.100 +/-0.127 | BP0254-0302-0381-BSHT |
| 25.400 (1.000") +0.051/+0.076 (mm) | 30.163 +0.076/+0.102 | 44.450 +/-0.190 | BP0254-0302-0445-BSHH |
| 25.400 (1.000") +0.076/+0.102 (mm) | 30.163 +0.038/+0.064 | 44.450 +/-0.190 | BP0254-0302-0445-BSHT |
| 25.400 (1.000") +0.025/+0.051 (mm) | 30.163 +0.025/+0.051 | 50.800 +/-0.190 | BP0254-0302-0508-BSTT |
| 25.400 (1.000") +0.051/+0.076 (mm) | 30.163 +0.076/+0.102 | 50.800 +/-0.190 | BP0254-0302-0508-BSHH |
| 25.400 (1.000") +0.076/+0.102 (mm) | 30.163 +0.038/+0.064 | 50.800 +/-0.190 | BP0254-0302-0508-BSHT |
| 25.400 (1.000") +0.000/+0.025 (mm) | 31.750 +0.025/+0.051 | 12.700 | BP0254-0318-0127-BSLT |
| 25.400 (1.000") +0.051/+0.076 (mm) | 31.750 +0.076/+0.102 | 12.700 +/-0.127 | BP0254-0318-0127-BSHH1 |
| 25.400 (1.000") +0.076/+0.102 (mm) | 31.750 +0.076/+0.102 | 12.700 +/-0.127 | BP0254-0318-0127-BSHH2 |
| 25.400 (1.000") +0.000/+0.025 (mm) | 31.750 +0.025/+0.051 | 19.050 +/-0.127 | BP0254-0318-0191-BSLT |
| 25.400 (1.000") +0.051/+0.076 (mm) | 31.750 +0.051/+0.076 | 19.050 +/-0.127 | BP0254-0318-0191-BSHH1 |
| 25.400 (1.000") +0.051/+0.076 (mm) | 31.750 +0.076/+0.102 | 19.050 +/-0.127 | BP0254-0318-0191-BSHH2 |
| 25.400 (1.000") +0.076/+0.102 (mm) | 31.750 +0.076/+0.102 | 19.050 +/-0.127 | BP0254-0318-0191-BSHH3 |
| 25.400 (1.000") +0.025/+0.051 (mm) | 31.750 +0.025/+0.051 | 22.225 | BP0254-0318-0222-BSTT |
| 25.400 (1.000") +0.051/+0.076 (mm) | 31.750 +0.051/+0.076 | 22.225 +/-0.127 | BP0254-0318-0222-BSHH1 |
| 25.400 (1.000") +0.051/+0.076 (mm) | 31.750 +0.076/+0.102 | 22.225 +/-0.127 | BP0254-0318-0222-BSHH2 |
| 25.400 (1.000") +0.076/+0.102 (mm) | 31.750 +0.076/+0.102 | 22.225 +/-0.127 | BP0254-0318-0222-BSHH3 |
| 25.400 (1.000") +0.000/+0.025 (mm) | 31.750 +0.025/+0.051 | 25.400 +/-0.127 | BP0254-0318-0254-BSLT |
| 25.400 (1.000") +0.025/+0.051 (mm) | 31.750 +0.025/+0.051 | 25.400 +/-0.127 | BP0254-0318-0254-BSTT |



Stocked or Short Delivery



Usually Available Short Delivery



Long delivery or not in current production

* Large Minimum Quantities

** Available only while stock lasts

Bushes - Plain

| Nominal ID (d) mm (inches) | Nominal OD (D) mm | Length (S) mm | Part Number |
|---------------------------------------|-------------------------|--------------------|-------------------------------|
| 25.400 (1.000") +0.051/+0.076 (mm) | 31.750 +0.051/+0.076 | 25.400 +/-0.127 | BP0254-0318-0254-BSHH2 |
| 25.400 (1.000") +0.051/+0.076 (mm) | 31.750 +0.051/+0.076 | 25.400 +/-0.127 | BP0254-0318-0254-BSHH1 |
| 25.400 (1.000") +0.051/+0.076 (mm) | 31.750 +0.076/+0.102 | 25.400 +/-0.127 | BP0254-0318-0254-BSHH3 |
| 25.400 (1.000") +0.051/+0.076 (mm) | 31.750 +0.076/+0.102 | 25.400 +/-0.127 | BP0254-0318-0254-BSHH4 |
| 25.400 (1.000") +0.076/+0.102 (mm) | 31.750 +0.076/+0.102 | 25.400 +/-0.127 | BP0254-0318-0254-BSHH5 |
| 25.400 (1.000") +0.102/+0.127 (mm) | 31.750 +0.038/+0.064 | 25.400 +/-0.127 | BP0254-0318-0254-BSHT |
| 25.400 (1.000") +0.025/+0.051 (mm) | 31.750 +0.025/+0.051 | 28.575 +/-0.127 | BP0254-0318-0286-BSTT |
| 25.400 (1.000") +0.051/+0.076 (mm) | 31.750 +0.051/+0.076 | 28.575 +/-0.127 | BP0254-0318-0286-BSHH |
| 25.400 (1.000") +0.000/+0.025 (mm) | 31.750 +0.025/+0.051 | 31.750 +/-0.127 | BP0254-0318-0318-BSLT |
| 25.400 (1.000") +0.025/+0.051 (mm) | 31.750 +0.025/+0.051 | 31.750 +/-0.127 | BP0254-0318-0318-BSTT |
| 25.400 (1.000") +0.051/+0.076 (mm) | 31.750 +0.051/+0.076 | 31.750 +/-0.127 | BP0254-0318-0318-BSHH2 |
| 25.400 (1.000") +0.051/+0.076 (mm) | 31.750 +0.051/+0.076 | 31.750 +/-0.127 | BP0254-0318-0318-BSHH1 |
| 25.400 (1.000") +0.051/+0.076 (mm) | 31.750 +0.076/+0.102 | 31.750 +/-0.127 | BP0254-0318-0318-BSHH4 |
| 25.400 (1.000") +0.051/+0.076 (mm) | 31.750 +0.076/+0.102 | 31.750 +/-0.127 | BP0254-0318-0318-BSHH3 |
| 25.400 (1.000") +0.076/+0.102 (mm) | 31.750 +0.076/+0.102 | 31.750 +/-0.127 | BP0254-0318-0318-BSHH5 |
| 25.400 (1.000") +0.102/+0.127 (mm) | 31.750 +0.038/+0.064 | 31.750 +/-0.127 | BP0254-0318-0318-BSHT |
| 25.400 (1.000") +0.051/+0.076 (mm) | 31.750 +0.051/+0.076 | 34.925 +/-0.127 | BP0254-0318-0349-BSHH1 |
| 25.400 (1.000") +0.051/+0.076 (mm) | 31.750 +0.076/+0.102 | 34.925 +/-0.127 | BP0254-0318-0349-BSHH2 |
| 25.400 (1.000") +0.076/+0.102 (mm) | 31.750 +0.076/+0.102 | 34.925 +/-0.127 | BP0254-0318-0349-BSHH |
| 25.400 (1.000") +0.102/+0.127 (mm) | 31.750 +0.038/+0.064 | 34.925 +/-0.127 | BP0254-0318-0349-BSHT2 |
| 25.400 (1.000") +0.000/+0.025 (mm) | 31.750 +0.025/+0.051 | 38.100 +/-0.127 | BP0254-0318-0381-BSLT |
| 25.400 (1.000") +0.025/+0.051 (mm) | 31.750 +0.025/+0.051 | 38.100 +/-0.127 | BP0254-0318-0381-BSTT |
| 25.400 (1.000") +0.051/+0.076 (mm) | 31.750 +0.051/+0.076 | 38.100 +/-0.127 | BP0254-0318-0381-BSHH1 |
| 25.400 (1.000") +0.051/+0.076 (mm) | 31.750 +0.051/+0.076 | 38.100 +/-0.127 | BP0254-0318-0381-BSHH2 |
| 25.400 (1.000") +0.051/+0.076 (mm) | 31.750 +0.076/+0.102 | 38.100 +/-0.127 | BP0254-0318-0381-BSHH3 |
| 25.400 (1.000") +0.051/+0.076 (mm) | 31.750 +0.076/+0.102 | 38.100 +/-0.127 | BP0254-0318-0381-BSHH4 |
| 25.400 (1.000") +0.076/+0.102 (mm) | 31.750 +0.076/+0.102 | 38.100 +/-0.127 | BP0254-0318-0381-BSHH5 |
| 25.400 (1.000") +0.102/+0.127 (mm) | 31.750 +0.038/+0.064 | 38.100 +/-0.127 | BP0254-0318-0381-BSHT |
| 25.400 (1.000") +0.000/+0.025 (mm) | 31.750 +0.025/+0.051 | 44.450 +/-0.190 | BP0254-0318-0445-BSLT |
| 25.400 (1.000") +0.025/+0.051 (mm) | 31.750 +0.025/+0.051 | 44.450 +/-0.190 | BP0254-0318-0445-BSTT |
| 25.400 (1.000") +0.051/+0.076 (mm) | 31.750 +0.051/+0.076 | 44.450 +/-0.190 | BP0254-0318-0445-BSHH2 |
| 25.400 (1.000") +0.051/+0.076 (mm) | 31.750 +0.051/+0.076 | 44.450 +/-0.190 | BP0254-0318-0445-BSHH1 |
| 25.400 (1.000") +0.051/+0.076 (mm) | 31.750 +0.076/+0.102 | 44.450 +/-0.190 | BP0254-0318-0445-BSHH4 |
| 25.400 (1.000") +0.051/+0.076 (mm) | 31.750 +0.076/+0.102 | 44.450 +/-0.190 | BP0254-0318-0445-BSHH3 |



Stocked or Short Delivery



Usually Available Short Delivery



Long delivery or not in current production

* Large Minimum Quantities

** Available only while stock lasts

Bushes - Plain

| Nominal ID (d) mm (inches) | Nominal OD (D) mm | Length (S) mm | Part Number |
|---------------------------------------|-------------------------|--------------------|-------------------------------|
| 25.400 (1.000") +0.076/+0.102 (mm) | 31.750 +0.076/+0.102 | 44.450 +/-0.190 | BP0254-0318-0445-BSHH5 |
| 25.400 (1.000") +0.000/+0.025 (mm) | 31.750 +0.025/+0.051 | 50.800 +/-0.190 | BP0254-0318-0508-BSLT |
| 25.400 (1.000") +0.025/+0.051 (mm) | 31.750 +0.025/+0.051 | 50.800 +/-0.190 | BP0254-0318-0508-BSTT |
| 25.400 (1.000") +0.051/+0.076 (mm) | 31.750 +0.051/+0.076 | 50.800 +/-0.190 | BP0254-0318-0508-BSHH2 |
| 25.400 (1.000") +0.051/+0.076 (mm) | 31.750 +0.051/+0.076 | 50.800 +/-0.190 | BP0254-0318-0508-BSHH1 |
| 25.400 (1.000") +0.051/+0.076 (mm) | 31.750 +0.076/+0.102 | 50.800 +/-0.190 | BP0254-0318-0508-BSHH4 |
| 25.400 (1.000") +0.051/+0.076 (mm) | 31.750 +0.076/+0.102 | 50.800 +/-0.190 | BP0254-0318-0508-BSHH3 |
| 25.400 (1.000") +0.076/+0.102 (mm) | 31.750 +0.076/+0.102 | 50.800 +/-0.190 | BP0254-0318-0508-BSHH5 |
| 25.400 (1.000") +0.102/+0.127 (mm) | 31.750 +0.038/+0.064 | 50.800 +/-0.190 | BP0254-0318-0508-BSHT |
| 25.400 (1.000") +0.000/+0.025 (mm) | 31.750 +0.025/+0.051 | 57.150 +/-0.190 | BP0254-0318-0572-BSLT |
| 25.400 (1.000") +0.051/+0.076 (mm) | 31.750 +0.051/+0.076 | 57.150 +/-0.190 | BP0254-0318-0572-BSHH1 |
| 25.400 (1.000") +0.051/+0.076 (mm) | 31.750 +0.076/+0.102 | 57.150 +/-0.190 | BP0254-0318-0572-BSHH2 |
| 25.400 (1.000") +0.076/+0.102 (mm) | 31.750 +0.076/+0.102 | 57.150 +/-0.190 | BP0254-0318-0572-BSHH3 |
| 25.400 (1.000") +0.102/+0.127 (mm) | 31.750 +0.038/+0.064 | 57.150 +/-0.190 | BP0254-0318-0572-BSHT |
| 25.400 (1.000") +0.000/+0.025 (mm) | 31.750 +0.025/+0.051 | 63.500 +/-0.190 | BP0254-0318-0635-BSLT |
| 25.400 (1.000") +0.025/+0.051 (mm) | 31.750 +0.025/+0.051 | 63.500 +/-0.190 | BP0254-0318-0635-BSTT |
| 25.400 (1.000") +0.051/+0.076 (mm) | 31.750 +0.051/+0.076 | 63.500 +/-0.190 | BP0254-0318-0635-BSHH1 |
| 25.400 (1.000") +0.051/+0.076 (mm) | 31.750 +0.051/+0.076 | 63.500 +/-0.190 | BP0254-0318-0635-BSHH2 |
| 25.400 (1.000") +0.051/+0.076 (mm) | 31.750 +0.076/+0.102 | 63.500 +/-0.190 | BP0254-0318-0635-BSHH4 |
| 25.400 (1.000") +0.051/+0.076 (mm) | 31.750 +0.076/+0.102 | 63.500 +/-0.190 | BP0254-0318-0635-BSHH3 |
| 25.400 (1.000") +0.076/+0.102 (mm) | 31.750 +0.076/+0.102 | 63.500 +/-0.190 | BP0254-0318-0635-BSHH5 |
| 25.400 (1.000") +0.102/+0.127 (mm) | 31.750 +0.038/+0.064 | 63.500 +/-0.190 | BP0254-0318-0635-BSHT |
| 25.400 (1.000") +0.000/+0.025 (mm) | 31.750 +0.025/+0.051 | 73.025 +/-0.190 | BP0254-0318-0730-BSLT |
| 25.400 (1.000") +0.000/+0.025 (mm) | 31.750 +0.025/+0.051 | 76.200 +/-0.190 | BP0254-0318-0762-BSLT |
| 25.400 (1.000") +0.025/+0.051 (mm) | 31.750 +0.025/+0.051 | 76.200 +/-0.190 | BP0254-0318-0762-BSTT |
| 25.400 (1.000") +0.051/+0.076 (mm) | 31.750 +0.051/+0.076 | 76.200 +/-0.190 | BP0254-0318-0762-BSHH1 |
| 25.400 (1.000") +0.051/+0.076 (mm) | 31.750 +0.051/+0.076 | 76.200 +/-0.190 | BP0254-0318-0762-BSHH2 |
| 25.400 (1.000") +0.051/+0.076 (mm) | 31.750 +0.076/+0.102 | 76.200 +/-0.190 | BP0254-0318-0762-BSHH4 |
| 25.400 (1.000") +0.051/+0.076 (mm) | 31.750 +0.076/+0.102 | 76.200 +/-0.190 | BP0254-0318-0762-BSHH3 |
| 25.400 (1.000") +0.076/+0.102 (mm) | 31.750 +0.076/+0.102 | 76.200 +/-0.190 | BP0254-0318-0762-BSHH5 |
| 25.400 (1.000") +0.000/+0.025 (mm) | 33.338 +0.064/+0.089 | 25.400 +/-0.127 | BP0254-0333-0254-BSLH |
| 25.400 (1.000") +0.025/+0.051 (mm) | 33.338 +0.038/+0.064 | 25.400 +/-0.127 | BP0254-0333-0254-BSTT |
| 25.400 (1.000") +0.076/+0.102 (mm) | 33.338 +0.064/+0.089 | 25.400 +/-0.127 | BP0254-0333-0254-BSHH |
| 25.400 (1.000") +0.025/+0.051 (mm) | 33.338 +0.038/+0.064 | 31.750 +/-0.127 | BP0254-0333-0318-BSTT |



Stocked or Short Delivery



Usually Available Short Delivery



Long delivery or not in current production

* Large Minimum Quantities

** Available only while stock lasts

Bushes - Plain

| Nominal ID (d) mm (inches) | Nominal OD (D) mm | Length (S) mm | Part Number |
|---------------------------------------|-------------------------|--------------------|-------------------------------|
| 25.400 (1.000") +0.076/+0.102 (mm) | 33.338 +0.064/+0.089 | 31.750 +/-0.127 | BP0254-0333-0318-BSHH |
| 25.400 (1.000") +0.000/+0.025 (mm) | 33.338 +0.064/+0.089 | 38.100 +/-0.127 | BP0254-0333-0381-BSLH |
| 25.400 (1.000") +0.025/+0.051 (mm) | 33.338 +0.038/+0.064 | 38.100 +/-0.127 | BP0254-0333-0381-BSTT |
| 25.400 (1.000") +0.076/+0.102 (mm) | 33.338 +0.064/+0.089 | 38.100 +/-0.127 | BP0254-0333-0381-BSHH |
| 25.400 (1.000") +0.025/+0.051 (mm) | 33.338 +0.038/+0.064 | 41.275 +/-0.190 | BP0254-0333-0413-BSTT |
| 25.400 (1.000") +0.000/+0.025 (mm) | 33.338 +0.064/+0.089 | 44.450 +/-0.190 | BP0254-0333-0445-BSLH |
| 25.400 (1.000") +0.025/+0.051 (mm) | 33.338 +0.038/+0.064 | 44.450 +/-0.190 | BP0254-0333-0445-BSTT |
| 25.400 (1.000") +0.076/+0.102 (mm) | 33.338 +0.064/+0.089 | 44.450 +/-0.190 | BP0254-0333-0445-BSHH |
| 25.400 (1.000") +0.000/+0.025 (mm) | 33.338 +0.064/+0.089 | 50.800 +/-0.190 | BP0254-0333-0508-BSLH |
| 25.400 (1.000") +0.025/+0.051 (mm) | 33.338 +0.038/+0.064 | 50.800 +/-0.190 | BP0254-0333-0508-BSTT |
| 25.400 (1.000") +0.076/+0.102 (mm) | 33.338 +0.064/+0.089 | 50.800 +/-0.190 | BP0254-0333-0508-BSHH |
| 25.400 (1.000") +0.025/+0.051 (mm) | 33.338 +0.038/+0.064 | 63.500 +/-0.190 | BP0254-0333-0635-BSTT |
| 25.400 (1.000") +0.076/+0.102 (mm) | 33.338 +0.064/+0.089 | 63.500 +/-0.190 | BP0254-0333-0635-BSHH |
| 25.400 (1.000") +0.025/+0.051 (mm) | 33.338 +0.038/+0.064 | 69.850 +/-0.190 | BP0254-0333-0699-BSTT |
| 25.400 (1.000") +0.025/+0.051 (mm) | 33.338 +0.038/+0.064 | 76.200 +/-0.190 | BP0254-0333-0762-BSTT |
| 25.400 (1.000") +0.076/+0.102 (mm) | 33.338 +0.064/+0.089 | 76.200 +/-0.190 | BP0254-0333-0762-BSHH |
| 25.400 (1.000") +0.000/+0.025 (mm) | 34.925 +0.051/+0.076 | 19.050 | BP0254-0349-0191-BSLH |
| 25.400 (1.000") +0.076/+0.102 (mm) | 34.925 +0.076/+0.102 | 19.050 +/-0.127 | BP0254-0349-0191-BSHH |
| 25.400 (1.000") +0.051/+0.076 (mm) | 34.925 +0.025/+0.051 | 25.400 | BP0254-0349-0254-BSHT |
| 25.400 (1.000") +0.051/+0.076 (mm) | 34.925 +0.051/+0.076 | 25.400 +/-0.127 | BP0254-0349-0254-BSHH1 |
| 25.400 (1.000") +0.051/+0.076 (mm) | 34.925 +0.076/+0.102 | 25.400 +/-0.127 | BP0254-0349-0254-BSHH2 |
| 25.400 (1.000") +0.076/+0.102 (mm) | 34.925 +0.076/+0.102 | 25.400 +/-0.127 | BP0254-0349-0254-BSHH3 |
| 25.400 (1.000") +0.051/+0.076 (mm) | 34.925 +0.025/+0.051 | 28.575 +/-0.127 | BP0254-0349-0286-BSHT |
| 25.400 (1.000") +0.000/+0.025 (mm) | 34.925 +0.051/+0.076 | 31.750 | BP0254-0349-0318-BSLH |
| 25.400 (1.000") +0.051/+0.076 (mm) | 34.925 +0.025/+0.051 | 31.750 | BP0254-0349-0318-BSHT |
| 25.400 (1.000") +0.051/+0.076 (mm) | 34.925 +0.051/+0.076 | 31.750 +/-0.127 | BP0254-0349-0318-BSHH1 |
| 25.400 (1.000") +0.051/+0.076 (mm) | 34.925 +0.076/+0.102 | 31.750 +/-0.127 | BP0254-0349-0318-BSHH2 |
| 25.400 (1.000") +0.076/+0.102 (mm) | 34.925 +0.076/+0.102 | 31.750 +/-0.127 | BP0254-0349-0318-BSHH3 |
| 25.400 (1.000") +0.051/+0.076 (mm) | 34.925 +0.025/+0.051 | 34.925 +/-0.127 | BP0254-0349-0349-BSHT |
| 25.400 (1.000") +0.000/+0.025 (mm) | 34.925 +0.051/+0.076 | 38.100 +/-0.127 | BP0254-0349-0381-BSLH |
| 25.400 (1.000") +0.051/+0.076 (mm) | 34.925 +0.025/+0.051 | 38.100 +/-0.127 | BP0254-0349-0381-BSHT |
| 25.400 (1.000") +0.051/+0.076 (mm) | 34.925 +0.051/+0.076 | 38.100 +/-0.127 | BP0254-0349-0381-BSHH1 |
| 25.400 (1.000") +0.051/+0.076 (mm) | 34.925 +0.076/+0.102 | 38.100 +/-0.127 | BP0254-0349-0381-BSHH2 |
| 25.400 (1.000") +0.076/+0.102 (mm) | 34.925 +0.076/+0.102 | 38.100 +/-0.127 | BP0254-0349-0381-BSHH3 |



Stocked or Short Delivery



Usually Available Short Delivery



Long delivery or not in current production

* Large Minimum Quantities

** Available only while stock lasts

Bushes - Plain

| Nominal ID (d) mm (inches) | Nominal OD (D) mm | Length (S) mm | Part Number |
|---------------------------------------|-------------------------|--------------------|-------------------------------|
| 25.400 (1.000") +0.051/+0.076 (mm) | 34.925 +0.025/+0.051 | 44.450 | BP0254-0349-0445-BSHT |
| 25.400 (1.000") +0.051/+0.076 (mm) | 34.925 +0.051/+0.076 | 44.450 +/-0.190 | BP0254-0349-0445-BSHH1 |
| 25.400 (1.000") +0.051/+0.076 (mm) | 34.925 +0.076/+0.102 | 44.450 +/-0.190 | BP0254-0349-0445-BSHH2 |
| 25.400 (1.000") +0.076/+0.102 (mm) | 34.925 +0.076/+0.102 | 44.450 +/-0.190 | BP0254-0349-0445-BSHH3 |
| 25.400 (1.000") +0.000/+0.025 (mm) | 34.925 +0.051/+0.076 | 50.800 +/-0.190 | BP0254-0349-0508-BSLH |
| 25.400 (1.000") +0.051/+0.076 (mm) | 34.925 +0.025/+0.051 | 50.800 +/-0.190 | BP0254-0349-0508-BSHT |
| 25.400 (1.000") +0.051/+0.076 (mm) | 34.925 +0.051/+0.076 | 50.800 +/-0.190 | BP0254-0349-0508-BSHH1 |
| 25.400 (1.000") +0.051/+0.076 (mm) | 34.925 +0.076/+0.102 | 50.800 +/-0.190 | BP0254-0349-0508-BSHH2 |
| 25.400 (1.000") +0.076/+0.102 (mm) | 34.925 +0.076/+0.102 | 50.800 +/-0.190 | BP0254-0349-0508-BSHH3 |
| 25.400 (1.000") +0.051/+0.076 (mm) | 34.925 +0.025/+0.051 | 57.150 +/-0.190 | BP0254-0349-0572-BSHT |
| 25.400 (1.000") +0.051/+0.076 (mm) | 34.925 +0.051/+0.076 | 63.500 +/-0.190 | BP0254-0349-0635-BSHH1 |
| 25.400 (1.000") +0.051/+0.076 (mm) | 34.925 +0.076/+0.102 | 63.500 +/-0.190 | BP0254-0349-0635-BSHH2 |
| 25.400 (1.000") +0.076/+0.102 (mm) | 34.925 +0.076/+0.102 | 63.500 +/-0.190 | BP0254-0349-0635-BSHH3 |
| 25.400 (1.000") +0.051/+0.076 (mm) | 34.925 +0.051/+0.076 | 76.200 +/-0.190 | BP0254-0349-0762-BSHH |
| 25.400 (1.000") +0.051/+0.076 (mm) | 38.100 +0.051/+0.076 | 25.400 +/-0.127 | BP0254-0381-0254-BSHH1 |
| 25.400 (1.000") +0.051/+0.076 (mm) | 38.100 +0.076/+0.102 | 25.400 +/-0.127 | BP0254-0381-0254-BSHH2 |
| 25.400 (1.000") +0.064/+0.089 (mm) | 38.100 +0.089/+0.114 | 25.400 | BP0254-0381-0254-BSHH3 |
| 25.400 (1.000") +0.076/+0.102 (mm) | 38.100 +0.076/+0.102 | 25.400 +/-0.127 | BP0254-0381-0254-BSHH4 |
| 25.400 (1.000") +0.051/+0.076 (mm) | 38.100 +0.051/+0.076 | 31.750 +/-0.127 | BP0254-0381-0318-BSHH1 |
| 25.400 (1.000") +0.051/+0.076 (mm) | 38.100 +0.076/+0.102 | 31.750 +/-0.127 | BP0254-0381-0318-BSHH2 |
| 25.400 (1.000") +0.064/+0.089 (mm) | 38.100 +0.089/+0.114 | 31.750 | BP0254-0381-0318-BSHH3 |
| 25.400 (1.000") +0.076/+0.102 (mm) | 38.100 +0.076/+0.102 | 31.750 +/-0.127 | BP0254-0381-0318-BSHH4 |
| 25.400 (1.000") +0.051/+0.076 (mm) | 38.100 +0.051/+0.076 | 38.100 +/-0.127 | BP0254-0381-0381-BSHH1 |
| 25.400 (1.000") +0.051/+0.076 (mm) | 38.100 +0.076/+0.102 | 38.100 +/-0.127 | BP0254-0381-0381-BSHH2 |
| 25.400 (1.000") +0.064/+0.089 (mm) | 38.100 +0.089/+0.114 | 38.100 | BP0254-0381-0381-BSHH3 |
| 25.400 (1.000") +0.076/+0.102 (mm) | 38.100 +0.076/+0.102 | 38.100 +/-0.127 | BP0254-0381-0381-BSHH4 |
| 25.400 (1.000") +0.051/+0.076 (mm) | 38.100 +0.076/+0.102 | 44.450 +/-0.190 | BP0254-0381-0445-BSHH1 |
| 25.400 (1.000") +0.076/+0.102 (mm) | 38.100 +0.076/+0.102 | 44.450 +/-0.190 | BP0254-0381-0445-BSHH2 |
| 25.400 (1.000") +0.051/+0.076 (mm) | 38.100 +0.051/+0.076 | 50.800 +/-0.190 | BP0254-0381-0508-BSHH1 |
| 25.400 (1.000") +0.051/+0.076 (mm) | 38.100 +0.076/+0.102 | 50.800 +/-0.190 | BP0254-0381-0508-BSHH2 |
| 25.400 (1.000") +0.064/+0.089 (mm) | 38.100 +0.089/+0.114 | 50.800 | BP0254-0381-0508-BSHH3 |
| 25.400 (1.000") +0.076/+0.102 (mm) | 38.100 +0.076/+0.102 | 50.800 +/-0.190 | BP0254-0381-0508-BSHH4 |
| 25.400 (1.000") +0.051/+0.076 (mm) | 38.100 +0.051/+0.076 | 63.500 +/-0.190 | BP0254-0381-0635-BSHH1 |
| 25.400 (1.000") +0.051/+0.076 (mm) | 38.100 +0.076/+0.102 | 63.500 +/-0.190 | BP0254-0381-0635-BSHH2 |



Stocked or Short Delivery



Usually Available Short Delivery



Long delivery or not in current production

* Large Minimum Quantities

** Available only while stock lasts

Bushes - Plain

| Nominal ID (d) mm (inches) | Nominal OD (D) mm | Length (S) mm | Part Number |
|---------------------------------------|-------------------------|--------------------|-------------------------------|
| 25.400 (1.000") +0.076/+0.102 (mm) | 38.100 +0.076/+0.102 | 63.500 +/-0.190 | BP0254-0381-0635-BSHH3 |
| 25.400 (1.000") +0.051/+0.076 (mm) | 38.100 +0.051/+0.076 | 76.200 +/-0.190 | BP0254-0381-0762-BSHH1 |
| 25.400 (1.000") +0.051/+0.076 (mm) | 38.100 +0.076/+0.102 | 76.200 +/-0.190 | BP0254-0381-0762-BSHH2 |
| 25.400 (1.000") +0.076/+0.102 (mm) | 38.100 +0.076/+0.102 | 76.200 +/-0.190 | BP0254-0381-0762-BSHH3 |
| 26.988 (1.063") +0.013/+0.038 (mm) | 33.338 +0.089/+0.114 | 19.050 +/-0.127 | BP0270-0333-0191-BSLH |
| 26.988 (1.063") +0.013/+0.038 (mm) | 33.338 +0.089/+0.114 | 25.400 +/-0.127 | BP0270-0333-0254-BSLH |
| 26.988 (1.063") +0.038/+0.064 (mm) | 33.338 +0.064/+0.089 | 25.400 +/-0.127 | BP0270-0333-0254-BSTH |
| 26.988 (1.063") +0.051/+0.076 (mm) | 33.338 +0.051/+0.076 | 25.400 +/-0.127 | BP0270-0333-0254-BSHH1 |
| 26.988 (1.063") +0.051/+0.076 (mm) | 33.338 +0.076/+0.102 | 25.400 +/-0.127 | BP0270-0333-0254-BSHH2 |
| 26.988 (1.063") +0.013/+0.038 (mm) | 33.338 +0.089/+0.114 | 31.750 +/-0.127 | BP0270-0333-0318-BSLH |
| 26.988 (1.063") +0.013/+0.038 (mm) | 33.338 +0.089/+0.114 | 38.100 +/-0.127 | BP0270-0333-0381-BSLH |
| 26.988 (1.063") +0.038/+0.064 (mm) | 33.338 +0.064/+0.089 | 38.100 +/-0.127 | BP0270-0333-0381-BSTH |
| 26.988 (1.063") +0.051/+0.076 (mm) | 33.338 +0.051/+0.076 | 38.100 +/-0.127 | BP0270-0333-0381-BSHH1 |
| 26.988 (1.063") +0.051/+0.076 (mm) | 33.338 +0.076/+0.102 | 38.100 +/-0.127 | BP0270-0333-0381-BSHH2 |
| 26.988 (1.063") +0.038/+0.064 (mm) | 33.338 +0.064/+0.089 | 50.800 +/-0.190 | BP0270-0333-0508-BSTH |
| 26.988 (1.063") +0.051/+0.076 (mm) | 33.338 +0.051/+0.076 | 50.800 +/-0.190 | BP0270-0333-0508-BSHH1 |
| 26.988 (1.063") +0.051/+0.076 (mm) | 33.338 +0.076/+0.102 | 50.800 +/-0.190 | BP0270-0333-0508-BSHH2 |
| 26.988 (1.063") +0.038/+0.064 (mm) | 33.338 +0.064/+0.089 | 63.500 +/-0.190 | BP0270-0333-0635-BSTH |
| 26.988 (1.063") +0.051/+0.076 (mm) | 33.338 +0.051/+0.076 | 63.500 +/-0.190 | BP0270-0333-0635-BSHH1 |
| 26.988 (1.063") +0.051/+0.076 (mm) | 33.338 +0.076/+0.102 | 63.500 +/-0.190 | BP0270-0333-0635-BSHH2 |
| 28.000 (1.102") +0.005/+0.030 (mm) | 32.000 +0.046/+0.071 | 22.000 +/-0.120 | BP0280-0320-0220-BSLH |
| 28.000 (1.102") +0.005/+0.030 (mm) | 32.000 +0.046/+0.071 | 25.000 +/-0.120 | BP0280-0320-0250-BSLH |
| 28.000 (1.102") +0.005/+0.030 (mm) | 32.000 +0.046/+0.071 | 28.000 +/-0.120 | BP0280-0320-0280-BSLH |
| 28.000 (1.102") +0.005/+0.030 (mm) | 32.000 +0.046/+0.071 | 30.000 +/-0.120 | BP0280-0320-0300-BSLH |
| 28.000 (1.102") +0.005/+0.030 (mm) | 32.000 +0.046/+0.071 | 36.000 +/-0.120 | BP0280-0320-0360-BSLH |
| 28.000 (1.102") +0.005/+0.030 (mm) | 32.000 +0.046/+0.071 | 45.000 +/-0.190 | BP0280-0320-0450-BSLH |
| 28.000 (1.102") +0.005/+0.030 (mm) | 33.000 +0.046/+0.071 | 22.000 +/-0.120 | BP0280-0330-0220-BSLH |
| 28.000 (1.102") +0.005/+0.030 (mm) | 33.000 +0.046/+0.071 | 28.000 +/-0.120 | BP0280-0330-0280-BSLH |
| 28.000 (1.102") +0.005/+0.030 (mm) | 36.000 +0.046/+0.071 | 22.000 +/-0.120 | BP0280-0360-0220-BSLH |
| 28.000 (1.102") +0.005/+0.030 (mm) | 36.000 +0.046/+0.071 | 28.000 +/-0.120 | BP0280-0360-0280-BSLH |
| 28.575 (1.125") -0.038/-0.013 (mm) | 31.750 +0.064/+0.089 | 22.225 +/-0.127 | BP0286-0318-0222-BSUH |
| 28.575 (1.125") +0.051/+0.076 (mm) | 31.750 +0.076/+0.102 | 25.400 +/-0.127 | BP0286-0318-0254-BSHH1 |
| 28.575 (1.125") +0.076/+0.102 (mm) | 31.750 +0.076/+0.102 | 25.400 +/-0.127 | BP0286-0318-0254-BSHH2 |
| 28.575 (1.125") -0.038/-0.013 (mm) | 31.750 +0.064/+0.089 | 25.400 | BP0286-0318-0254-BSUH |



Stocked or Short Delivery



Usually Available Short Delivery



Long delivery or not in current production

* Large Minimum Quantities

** Available only while stock lasts

Bushes - Plain

| Nominal ID (d) mm (inches) | Nominal OD (D) mm | Length (S) mm | Part Number |
|---------------------------------------|-------------------------|--------------------|-------------------------------|
| 28.575 (1.125") -0.038/-0.013 (mm) | 31.750 +0.064/+0.089 | 28.575 +/-0.127 | BP0286-0318-0286-BSUH |
| 28.575 (1.125") +0.025/+0.051 (mm) | 31.750 +0.038/+0.064 | 31.750 +/-0.127 | BP0286-0318-0318-BSTT |
| 28.575 (1.125") +0.051/+0.076 (mm) | 31.750 +0.076/+0.102 | 31.750 +/-0.127 | BP0286-0318-0318-BSHH1 |
| 28.575 (1.125") +0.076/+0.102 (mm) | 31.750 +0.076/+0.102 | 31.750 +/-0.127 | BP0286-0318-0318-BSHH2 |
| 28.575 (1.125") -0.038/-0.013 (mm) | 31.750 +0.064/+0.089 | 31.750 +/-0.127 | BP0286-0318-0318-BSUH |
| 28.575 (1.125") +0.025/+0.051 (mm) | 31.750 +0.038/+0.064 | 38.100 +/-0.127 | BP0286-0318-0381-BSTT |
| 28.575 (1.125") +0.051/+0.076 (mm) | 31.750 +0.076/+0.102 | 38.100 +/-0.127 | BP0286-0318-0381-BSHH1 |
| 28.575 (1.125") +0.076/+0.102 (mm) | 31.750 +0.076/+0.102 | 38.100 +/-0.127 | BP0286-0318-0381-BSHH2 |
| 28.575 (1.125") -0.038/-0.013 (mm) | 31.750 +0.064/+0.089 | 38.100 +/-0.127 | BP0286-0318-0381-BSUH |
| 28.575 (1.125") +0.013/+0.038 (mm) | 33.338 +0.051/+0.076 | 25.400 +/-0.127 | BP0286-0333-0254-BSLH |
| 28.575 (1.125") +0.051/+0.076 (mm) | 33.338 +0.051/+0.076 | 25.400 +/-0.127 | BP0286-0333-0254-BSHH1 |
| 28.575 (1.125") +0.051/+0.076 (mm) | 33.338 +0.076/+0.102 | 25.400 +/-0.127 | BP0286-0333-0254-BSHH2 |
| 28.575 (1.125") +0.076/+0.102 (mm) | 33.338 +0.064/+0.089 | 25.400 +/-0.127 | BP0286-0333-0254-BSHH3 |
| 28.575 (1.125") +0.013/+0.038 (mm) | 33.338 +0.051/+0.076 | 31.750 +/-0.127 | BP0286-0333-0318-BSLH |
| 28.575 (1.125") +0.051/+0.076 (mm) | 33.338 +0.051/+0.076 | 31.750 +/-0.127 | BP0286-0333-0318-BSHH1 |
| 28.575 (1.125") +0.051/+0.076 (mm) | 33.338 +0.076/+0.102 | 31.750 +/-0.127 | BP0286-0333-0318-BSHH2 |
| 28.575 (1.125") +0.076/+0.102 (mm) | 33.338 +0.064/+0.089 | 31.750 +/-0.127 | BP0286-0333-0318-BSHH3 |
| 28.575 (1.125") +0.051/+0.076 (mm) | 33.338 +0.051/+0.076 | 38.100 +/-0.127 | BP0286-0333-0381-BSHH1 |
| 28.575 (1.125") +0.051/+0.076 (mm) | 33.338 +0.076/+0.102 | 38.100 +/-0.127 | BP0286-0333-0381-BSHH2 |
| 28.575 (1.125") +0.076/+0.102 (mm) | 33.338 +0.064/+0.089 | 38.100 +/-0.127 | BP0286-0333-0381-BSHH3 |
| 28.575 (1.125") +0.051/+0.076 (mm) | 33.338 +0.076/+0.102 | 44.450 +/-0.190 | BP0286-0333-0445-BSHH1 |
| 28.575 (1.125") +0.076/+0.102 (mm) | 33.338 +0.064/+0.089 | 44.450 +/-0.190 | BP0286-0333-0445-BSHH2 |
| 28.575 (1.125") +0.051/+0.076 (mm) | 33.338 +0.051/+0.076 | 50.800 +/-0.190 | BP0286-0333-0508-BSHH1 |
| 28.575 (1.125") +0.051/+0.076 (mm) | 33.338 +0.076/+0.102 | 50.800 +/-0.190 | BP0286-0333-0508-BSHH2 |
| 28.575 (1.125") +0.076/+0.102 (mm) | 33.338 +0.064/+0.089 | 50.800 +/-0.190 | BP0286-0333-0508-BSHH3 |
| 28.575 (1.125") +0.025/+0.051 (mm) | 34.925 +0.025/+0.051 | 12.700 +/-0.127 | BP0286-0349-0127-BSTT |
| 28.575 (1.125") +0.051/+0.076 (mm) | 34.925 +0.076/+0.102 | 12.700 +/-0.127 | BP0286-0349-0127-BSHH1 |
| 28.575 (1.125") +0.076/+0.102 (mm) | 34.925 +0.076/+0.102 | 12.700 +/-0.127 | BP0286-0349-0127-BSHH2 |
| 28.575 (1.125") +0.025/+0.051 (mm) | 34.925 +0.025/+0.051 | 19.050 +/-0.127 | BP0286-0349-0191-BSTT |
| 28.575 (1.125") +0.051/+0.076 (mm) | 34.925 +0.051/+0.076 | 19.050 +/-0.127 | BP0286-0349-0191-BSHH1 |
| 28.575 (1.125") +0.051/+0.076 (mm) | 34.925 +0.076/+0.102 | 19.050 +/-0.127 | BP0286-0349-0191-BSHH2 |
| 28.575 (1.125") +0.076/+0.102 (mm) | 34.925 +0.076/+0.102 | 19.050 +/-0.127 | BP0286-0349-0191-BSHH3 |
| 28.575 (1.125") +0.025/+0.051 (mm) | 34.925 +0.025/+0.051 | 25.400 +/-0.127 | BP0286-0349-0254-BSTT |
| 28.575 (1.125") +0.051/+0.076 (mm) | 34.925 +0.051/+0.076 | 25.400 +/-0.127 | BP0286-0349-0254-BSHH1 |

Stocked or Short Delivery
 Usually Available Short Delivery
 Long delivery or not in current production

* Large Minimum Quantities

** Available only while stock lasts

Bushes - Plain

| Nominal ID (d) mm (inches) | Nominal OD (D) mm | Length (S) mm | Part Number |
|---------------------------------------|-------------------------|--------------------|------------------------|
| 28.575 (1.125") +0.051/+0.076 (mm) | 34.925 +0.076/+0.102 | 25.400 +/-0.127 | BP0286-0349-0254-BSHH2 |
| 28.575 (1.125") +0.076/+0.102 (mm) | 34.925 +0.076/+0.102 | 25.400 +/-0.127 | BP0286-0349-0254-BSHH3 |
| 28.575 (1.125") +0.025/+0.051 (mm) | 34.925 +0.025/+0.051 | 31.750 +/-0.127 | BP0286-0349-0318-BSTT |
| 28.575 (1.125") +0.051/+0.076 (mm) | 34.925 +0.051/+0.076 | 31.750 +/-0.127 | BP0286-0349-0318-BSHH1 |
| 28.575 (1.125") +0.051/+0.076 (mm) | 34.925 +0.076/+0.102 | 31.750 +/-0.127 | BP0286-0349-0318-BSHH2 |
| 28.575 (1.125") +0.076/+0.102 (mm) | 34.925 +0.076/+0.102 | 31.750 +/-0.127 | BP0286-0349-0318-BSHH3 |
| 28.575 (1.125") +0.025/+0.051 (mm) | 34.925 +0.025/+0.051 | 38.100 +/-0.127 | BP0286-0349-0381-BSTT |
| 28.575 (1.125") +0.051/+0.076 (mm) | 34.925 +0.051/+0.076 | 38.100 +/-0.127 | BP0286-0349-0381-BSHH1 |
| 28.575 (1.125") +0.051/+0.076 (mm) | 34.925 +0.076/+0.102 | 38.100 +/-0.127 | BP0286-0349-0381-BSHH2 |
| 28.575 (1.125") +0.076/+0.102 (mm) | 34.925 +0.076/+0.102 | 38.100 +/-0.127 | BP0286-0349-0381-BSHH3 |
| 28.575 (1.125") +0.025/+0.051 (mm) | 34.925 +0.025/+0.051 | 44.450 +/-0.190 | BP0286-0349-0445-BSTT |
| 28.575 (1.125") +0.051/+0.076 (mm) | 34.925 +0.051/+0.076 | 44.450 +/-0.190 | BP0286-0349-0445-BSHH1 |
| 28.575 (1.125") +0.051/+0.076 (mm) | 34.925 +0.076/+0.102 | 44.450 +/-0.190 | BP0286-0349-0445-BSHH2 |
| 28.575 (1.125") +0.076/+0.102 (mm) | 34.925 +0.076/+0.102 | 44.450 +/-0.190 | BP0286-0349-0445-BSHH3 |
| 28.575 (1.125") +0.025/+0.051 (mm) | 34.925 +0.025/+0.051 | 50.800 +/-0.190 | BP0286-0349-0508-BSTT |
| 28.575 (1.125") +0.051/+0.076 (mm) | 34.925 +0.051/+0.076 | 50.800 +/-0.190 | BP0286-0349-0508-BSHH1 |
| 28.575 (1.125") +0.051/+0.076 (mm) | 34.925 +0.076/+0.102 | 50.800 +/-0.190 | BP0286-0349-0508-BSHH2 |
| 28.575 (1.125") +0.076/+0.102 (mm) | 34.925 +0.076/+0.102 | 50.800 +/-0.190 | BP0286-0349-0508-BSHH3 |
| 28.575 (1.125") +0.025/+0.051 (mm) | 34.925 +0.025/+0.051 | 57.150 +/-0.190 | BP0286-0349-0572-BSTT |
| 28.575 (1.125") +0.076/+0.102 (mm) | 34.925 +0.076/+0.102 | 57.150 +/-0.190 | BP0286-0349-0572-BSHH |
| 28.575 (1.125") +0.025/+0.051 (mm) | 34.925 +0.025/+0.051 | 63.500 +/-0.190 | BP0286-0349-0635-BSTT |
| 28.575 (1.125") +0.051/+0.076 (mm) | 34.925 +0.051/+0.076 | 63.500 +/-0.190 | BP0286-0349-0635-BSHH1 |
| 28.575 (1.125") +0.051/+0.076 (mm) | 34.925 +0.076/+0.102 | 63.500 +/-0.190 | BP0286-0349-0635-BSHH2 |
| 28.575 (1.125") +0.076/+0.102 (mm) | 34.925 +0.076/+0.102 | 63.500 +/-0.190 | BP0286-0349-0635-BSHH3 |
| 28.575 (1.125") +0.025/+0.051 (mm) | 34.925 +0.025/+0.051 | 76.200 +/-0.190 | BP0286-0349-0762-BSTT |
| 28.575 (1.125") +0.051/+0.076 (mm) | 34.925 +0.051/+0.076 | 76.200 +/-0.190 | BP0286-0349-0762-BSHH1 |
| 28.575 (1.125") +0.051/+0.076 (mm) | 34.925 +0.076/+0.102 | 76.200 +/-0.190 | BP0286-0349-0762-BSHH2 |
| 28.575 (1.125") +0.076/+0.102 (mm) | 34.925 +0.076/+0.102 | 76.200 +/-0.190 | BP0286-0349-0762-BSHH3 |
| 28.575 (1.125") +0.000/+0.025 (mm) | 38.100 +0.051/+0.076 | 25.400 +/-0.127 | BP0286-0381-0254-BSLH |
| 28.575 (1.125") +0.025/+0.051 (mm) | 38.100 +0.064/+0.089 | 25.400 +/-0.127 | BP0286-0381-0254-BSTH |
| 28.575 (1.125") +0.051/+0.076 (mm) | 38.100 +0.076/+0.102 | 25.400 +/-0.127 | BP0286-0381-0254-BSHH1 |
| 28.575 (1.125") +0.076/+0.102 (mm) | 38.100 +0.076/+0.102 | 25.400 +/-0.127 | BP0286-0381-0254-BSHH2 |
| 28.575 (1.125") +0.025/+0.051 (mm) | 38.100 +0.064/+0.089 | 31.750 +/-0.127 | BP0286-0381-0318-BSTH |
| 28.575 (1.125") +0.051/+0.076 (mm) | 38.100 +0.076/+0.102 | 31.750 +/-0.127 | BP0286-0381-0318-BSHH1 |



Stocked or Short Delivery



Usually Available Short Delivery



Long delivery or not in current production

* Large Minimum Quantities

** Available only while stock lasts

Bushes - Plain

| Nominal ID (d) mm (inches) | Nominal OD (D) mm | Length (S) mm | Part Number |
|---------------------------------------|-------------------------|--------------------|-------------------------------|
| 28.575 (1.125") +0.076/+0.102 (mm) | 38.100 +0.076/+0.102 | 31.750 +/-0.127 | BP0286-0381-0318-BSHH2 |
| 28.575 (1.125") +0.000/+0.025 (mm) | 38.100 +0.051/+0.076 | 38.100 +/-0.127 | BP0286-0381-0381-BSLH |
| 28.575 (1.125") +0.025/+0.051 (mm) | 38.100 +0.064/+0.089 | 38.100 +/-0.127 | BP0286-0381-0381-BSTH |
| 28.575 (1.125") +0.051/+0.076 (mm) | 38.100 +0.076/+0.102 | 38.100 +/-0.127 | BP0286-0381-0381-BSHH1 |
| 28.575 (1.125") +0.076/+0.102 (mm) | 38.100 +0.076/+0.102 | 38.100 +/-0.127 | BP0286-0381-0381-BSHH2 |
| 28.575 (1.125") +0.000/+0.025 (mm) | 38.100 +0.051/+0.076 | 44.450 | BP0286-0381-0445-BSLH |
| 28.575 (1.125") +0.051/+0.076 (mm) | 38.100 +0.076/+0.102 | 44.450 +/-0.190 | BP0286-0381-0445-BSHH1 |
| 28.575 (1.125") +0.076/+0.102 (mm) | 38.100 +0.076/+0.102 | 44.450 +/-0.190 | BP0286-0381-0445-BSHH2 |
| 28.575 (1.125") +0.000/+0.025 (mm) | 38.100 +0.051/+0.076 | 50.800 | BP0286-0381-0508-BSLH |
| 28.575 (1.125") +0.051/+0.076 (mm) | 38.100 +0.076/+0.102 | 50.800 +/-0.190 | BP0286-0381-0508-BSHH1 |
| 28.575 (1.125") +0.076/+0.102 (mm) | 38.100 +0.076/+0.102 | 50.800 +/-0.190 | BP0286-0381-0508-BSHH2 |
| 28.575 (1.125") +0.000/+0.025 (mm) | 38.100 +0.051/+0.076 | 63.500 | BP0286-0381-0635-BSLH |
| 28.575 (1.125") +0.051/+0.076 (mm) | 38.100 +0.076/+0.102 | 63.500 +/-0.190 | BP0286-0381-0635-BSHH1 |
| 28.575 (1.125") +0.076/+0.102 (mm) | 38.100 +0.076/+0.102 | 63.500 +/-0.190 | BP0286-0381-0635-BSHH2 |
| 30.000 (1.181") +0.005/+0.030 (mm) | 35.000 +0.040/+0.070 | 15.000 +/-0.120 | BP0300-0350-0150-BSLT |
| 30.000 (1.181") +0.005/+0.030 (mm) | 35.000 +0.040/+0.070 | 20.000 +/-0.127 | BP0300-0350-0200-BSLT |
| 30.000 (1.181") +0.005/+0.030 (mm) | 35.000 +0.040/+0.070 | 25.000 +/-0.127 | BP0300-0350-0250-BSLT |
| 30.000 (1.181") +0.005/+0.030 (mm) | 35.000 +0.040/+0.070 | 30.000 +/-0.127 | BP0300-0350-0300-BSLT |
| 30.000 (1.181") +0.005/+0.030 (mm) | 38.000 +0.040/+0.070 | 15.000 +/-0.120 | BP0300-0380-0150-BSLT |
| 30.000 (1.181") +0.005/+0.030 (mm) | 38.000 +0.040/+0.070 | 20.000 +/-0.120 | BP0300-0380-0200-BSLT |
| 30.000 (1.181") +0.005/+0.030 (mm) | 38.000 +0.040/+0.070 | 24.000 +/-0.120 | BP0300-0380-0240-BSLT |
| 30.000 (1.181") +0.005/+0.030 (mm) | 38.000 +0.040/+0.070 | 25.000 +/-0.120 | BP0300-0380-0250-BSLT |
| 30.000 (1.181") +0.005/+0.030 (mm) | 38.000 +0.040/+0.070 | 30.000 +/-0.120 | BP0300-0380-0300-BSLT |
| 30.000 (1.181") +0.005/+0.030 (mm) | 38.000 +0.040/+0.070 | 38.000 +/-0.120 | BP0300-0380-0380-BSLT |
| 30.000 (1.181") +0.005/+0.030 (mm) | 40.000 +0.033/+0.071 | 35.000 +/-0.127 | BP0300-0400-0350-BSLL |
| 30.163 (1.188") +0.013/+0.038 (mm) | 33.338 +0.051/+0.076 | 25.400 +/-0.127 | BP0302-0333-0254-BSLH |
| 30.163 (1.188") +0.013/+0.038 (mm) | 33.338 +0.051/+0.076 | 31.750 +/-0.127 | BP0302-0333-0318-BSLH |
| 30.163 (1.188") +0.013/+0.038 (mm) | 34.925 +0.076/+0.102 | 38.100 +/-0.127 | BP0302-0349-0381-BSLH |
| 30.163 (1.188") +0.013/+0.038 (mm) | 34.925 +0.076/+0.102 | 44.450 +/-0.190 | BP0302-0349-0445-BSLH |
| 30.163 (1.188") +0.000/+0.025 (mm) | 36.513 +0.064/+0.089 | 31.750 | BP0302-0365-0318-BSLH |
| 30.163 (1.188") +0.051/+0.076 (mm) | 36.513 +0.064/+0.089 | 31.750 +/-0.127 | BP0302-0365-0318-BSHH1 |
| 30.163 (1.188") +0.051/+0.076 (mm) | 36.513 +0.076/+0.102 | 31.750 +/-0.127 | BP0302-0365-0318-BSHH2 |
| 30.163 (1.188") +0.089/+0.114 (mm) | 36.513 +0.064/+0.089 | 31.750 +/-0.127 | BP0302-0365-0318-BSHH3 |
| 30.163 (1.188") +0.000/+0.025 (mm) | 36.513 +0.064/+0.089 | 38.100 | BP0302-0365-0381-BSLH |



Stocked or Short Delivery



Usually Available Short Delivery



Long delivery or not in current production

* Large Minimum Quantities

** Available only while stock lasts

Bushes - Plain

| Nominal ID (d) mm (inches) | Nominal OD (D) mm | Length (S) mm | Part Number |
|---------------------------------------|-------------------------|--------------------|-------------------------------|
| 30.163 (1.188") +0.051/+0.076 (mm) | 36.513 +0.076/+0.102 | 38.100 +/-0.127 | BP0302-0365-0381-BSHH1 |
| 30.163 (1.188") +0.089/+0.114 (mm) | 36.513 +0.064/+0.089 | 38.100 +/-0.127 | BP0302-0365-0381-BSHH2 |
| 30.163 (1.188") +0.000/+0.025 (mm) | 36.513 +0.064/+0.089 | 50.800 | BP0302-0365-0508-BSLH |
| 30.163 (1.188") +0.051/+0.076 (mm) | 36.513 +0.064/+0.089 | 50.800 +/-0.190 | BP0302-0365-0508-BSHH1 |
| 30.163 (1.188") +0.051/+0.076 (mm) | 36.513 +0.076/+0.102 | 50.800 +/-0.190 | BP0302-0365-0508-BSHH2 |
| 30.163 (1.188") +0.089/+0.114 (mm) | 36.513 +0.064/+0.089 | 50.800 +/-0.190 | BP0302-0365-0508-BSHH3 |
| 30.163 (1.188") +0.051/+0.076 (mm) | 36.513 +0.064/+0.089 | 63.500 +/-0.190 | BP0302-0365-0635-BSHH1 |
| 30.163 (1.188") +0.051/+0.076 (mm) | 36.513 +0.076/+0.102 | 63.500 +/-0.190 | BP0302-0365-0635-BSHH2 |
| 30.163 (1.188") +0.089/+0.114 (mm) | 36.513 +0.064/+0.089 | 63.500 +/-0.190 | BP0302-0365-0635-BSHH3 |
| 30.163 (1.188") +0.051/+0.076 (mm) | 36.513 +0.064/+0.089 | 76.200 +/-0.190 | BP0302-0365-0762-BSHH1 |
| 30.163 (1.188") +0.051/+0.076 (mm) | 36.513 +0.076/+0.102 | 76.200 +/-0.190 | BP0302-0365-0762-BSHH2 |
| 30.163 (1.188") +0.089/+0.114 (mm) | 36.513 +0.064/+0.089 | 76.200 +/-0.190 | BP0302-0365-0762-BSHH3 |
| 30.163 (1.188") +/-0.013 (mm) | 38.100 +0.076/+0.102 | 25.400 | BP0302-0381-0254-BSUH |
| 30.163 (1.188") +0.051/+0.076 (mm) | 38.100 +0.051/+0.076 | 25.400 +/-0.127 | BP0302-0381-0254-BSHH1 |
| 30.163 (1.188") +0.051/+0.076 (mm) | 38.100 +0.076/+0.102 | 25.400 +/-0.127 | BP0302-0381-0254-BSHH2 |
| 30.163 (1.188") +0.089/+0.114 (mm) | 38.100 +0.076/+0.102 | 25.400 +/-0.127 | BP0302-0381-0254-BSHH3 |
| 30.163 (1.188") +0.114/+0.140 (mm) | 38.100 +0.076/+0.102 | 25.400 | BP0302-0381-0254-BSHH4 |
| 30.163 (1.188") +0.051/+0.076 (mm) | 38.100 +0.051/+0.076 | 31.750 +/-0.127 | BP0302-0381-0318-BSHH1 |
| 30.163 (1.188") +0.051/+0.076 (mm) | 38.100 +0.076/+0.102 | 31.750 +/-0.127 | BP0302-0381-0318-BSHH2 |
| 30.163 (1.188") +0.089/+0.114 (mm) | 38.100 +0.076/+0.102 | 31.750 +/-0.127 | BP0302-0381-0318-BSHH3 |
| 30.163 (1.188") +0.038/+0.064 (mm) | 38.100 +0.076/+0.102 | 38.100 +/-0.127 | BP0302-0381-0381-BSTH |
| 30.163 (1.188") +0.051/+0.076 (mm) | 38.100 +0.051/+0.076 | 38.100 +/-0.127 | BP0302-0381-0381-BSHH1 |
| 30.163 (1.188") +0.051/+0.076 (mm) | 38.100 +0.076/+0.102 | 38.100 +/-0.127 | BP0302-0381-0381-BSHH2 |
| 30.163 (1.188") +0.089/+0.114 (mm) | 38.100 +0.076/+0.102 | 38.100 +/-0.127 | BP0302-0381-0381-BSHH3 |
| 30.163 (1.188") +0.114/+0.140 (mm) | 38.100 +0.076/+0.102 | 38.100 +/-0.127 | BP0302-0381-0381-BSHH4 |
| 30.163 (1.188") +0.051/+0.076 (mm) | 38.100 +0.051/+0.076 | 44.450 +/-0.190 | BP0302-0381-0445-BSHH1 |
| 30.163 (1.188") +0.051/+0.076 (mm) | 38.100 +0.076/+0.102 | 44.450 +/-0.190 | BP0302-0381-0445-BSHH2 |
| 30.163 (1.188") +0.089/+0.114 (mm) | 38.100 +0.076/+0.102 | 44.450 +/-0.190 | BP0302-0381-0445-BSHH3 |
| 30.163 (1.188") +/-0.013 (mm) | 38.100 +0.076/+0.102 | 50.800 | BP0302-0381-0508-BSUH |
| 30.163 (1.188") +0.051/+0.076 (mm) | 38.100 +0.051/+0.076 | 50.800 +/-0.190 | BP0302-0381-0508-BSHH1 |
| 30.163 (1.188") +0.051/+0.076 (mm) | 38.100 +0.076/+0.102 | 50.800 +/-0.190 | BP0302-0381-0508-BSHH2 |
| 30.163 (1.188") +0.089/+0.114 (mm) | 38.100 +0.076/+0.102 | 50.800 +/-0.190 | BP0302-0381-0508-BSHH3 |
| 30.163 (1.188") +/-0.013 (mm) | 38.100 +0.076/+0.102 | 63.500 | BP0302-0381-0635-BSUH |
| 30.163 (1.188") +0.051/+0.076 (mm) | 38.100 +0.051/+0.076 | 63.500 +/-0.190 | BP0302-0381-0635-BSHH1 |



Stocked or Short Delivery



Usually Available Short Delivery



Long delivery or not in current production

* Large Minimum Quantities

** Available only while stock lasts

Bushes - Plain

| Nominal ID (d) mm (inches) | Nominal OD (D) mm | Length (S) mm | Part Number |
|---------------------------------------|-------------------------|--------------------|-------------------------------|
| 30.163 (1.188") +0.051/+0.076 (mm) | 38.100 +0.076/+0.102 | 63.500 +/-0.190 | BP0302-0381-0635-BSHH2 |
| 30.163 (1.188") +0.089/+0.114 (mm) | 38.100 +0.076/+0.102 | 63.500 +/-0.190 | BP0302-0381-0635-BSHH3 |
| 30.163 (1.188") +0.051/+0.076 (mm) | 38.100 +0.051/+0.076 | 76.200 +/-0.190 | BP0302-0381-0762-BSHH1 |
| 30.163 (1.188") +0.051/+0.076 (mm) | 38.100 +0.076/+0.102 | 76.200 +/-0.190 | BP0302-0381-0762-BSHH2 |
| 30.163 (1.188") +0.089/+0.114 (mm) | 38.100 +0.076/+0.102 | 76.200 +/-0.190 | BP0302-0381-0762-BSHH3 |
| 31.750 (1.250") +0.013/+0.038 (mm) | 36.513 +0.051/+0.076 | 31.750 +/-0.127 | BP0318-0365-0318-BSLH |
| 31.750 (1.250") +0.013/+0.038 (mm) | 36.513 +0.051/+0.076 | 38.100 +/-0.127 | BP0318-0365-0381-BSLH |
| 31.750 (1.250") +0.013/+0.038 (mm) | 36.513 +0.051/+0.076 | 44.450 +/-0.190 | BP0318-0365-0445-BSLH |
| 31.750 (1.250") +0.013/+0.038 (mm) | 36.513 +0.051/+0.076 | 50.800 +/-0.190 | BP0318-0365-0508-BSLH |
| 31.750 (1.250") +0.013/+0.038 (mm) | 36.513 +0.051/+0.076 | 63.500 +/-0.190 | BP0318-0365-0635-BSLH |
| 31.750 (1.250") +0.025/+0.051 (mm) | 38.100 +0.025/+0.051 | 12.700 +/-0.127 | BP0318-0381-0127-BSTT |
| 31.750 (1.250") +0.064/+0.089 (mm) | 38.100 +0.076/+0.102 | 12.700 +/-0.127 | BP0318-0381-0127-BSHH1 |
| 31.750 (1.250") +0.076/+0.102 (mm) | 38.100 +0.076/+0.102 | 12.700 +/-0.127 | BP0318-0381-0127-BSHH2 |
| 31.750 (1.250") +0.025/+0.051 (mm) | 38.100 +0.025/+0.051 | 15.875 +/-0.127 | BP0318-0381-0159-BSTT |
| 31.750 (1.250") +0.064/+0.089 (mm) | 38.100 +0.076/+0.102 | 15.875 +/-0.127 | BP0318-0381-0159-BSHH1 |
| 31.750 (1.250") +0.076/+0.102 (mm) | 38.100 +0.076/+0.102 | 15.875 +/-0.127 | BP0318-0381-0159-BSHH2 |
| 31.750 (1.250") +0.025/+0.051 (mm) | 38.100 +0.025/+0.051 | 19.050 +/-0.127 | BP0318-0381-0191-BSTT |
| 31.750 (1.250") +0.051/+0.076 (mm) | 38.100 +0.076/+0.102 | 19.050 +/-0.127 | BP0318-0381-0191-BSHH1 |
| 31.750 (1.250") +0.064/+0.089 (mm) | 38.100 +0.076/+0.102 | 19.050 +/-0.127 | BP0318-0381-0191-BSHH2 |
| 31.750 (1.250") +0.076/+0.102 (mm) | 38.100 +0.076/+0.102 | 19.050 +/-0.127 | BP0318-0381-0191-BSHH3 |
| 31.750 (1.250") -0.025/+0.000 (mm) | 38.100 +0.025/+0.051 | 19.050 +/-0.127 | BP0318-0381-0191-BSUT |
| 31.750 (1.250") +0.025/+0.051 (mm) | 38.100 +0.025/+0.051 | 22.225 +/-0.127 | BP0318-0381-0222-BSTT |
| 31.750 (1.250") +0.064/+0.089 (mm) | 38.100 +0.076/+0.102 | 22.225 +/-0.127 | BP0318-0381-0222-BSHH1 |
| 31.750 (1.250") +0.076/+0.102 (mm) | 38.100 +0.076/+0.102 | 22.225 +/-0.127 | BP0318-0381-0222-BSHH2 |
| 31.750 (1.250") +0.025/+0.051 (mm) | 38.100 +0.025/+0.051 | 25.400 +/-0.127 | BP0318-0381-0254-BSTT |
| 31.750 (1.250") +0.051/+0.076 (mm) | 38.100 +0.051/+0.076 | 25.400 +/-0.127 | BP0318-0381-0254-BSHH1 |
| 31.750 (1.250") +0.051/+0.076 (mm) | 38.100 +0.076/+0.102 | 25.400 +/-0.127 | BP0318-0381-0254-BSHH2 |
| 31.750 (1.250") +0.064/+0.089 (mm) | 38.100 +0.076/+0.102 | 25.400 +/-0.127 | BP0318-0381-0254-BSHH3 |
| 31.750 (1.250") +0.076/+0.102 (mm) | 38.100 +0.076/+0.102 | 25.400 +/-0.127 | BP0318-0381-0254-BSHH4 |
| 31.750 (1.250") +0.178/+0.203 (mm) | 38.100 +0.076/+0.102 | 25.400 +/-0.127 | BP0318-0381-0254-BSHH5 |
| 31.750 (1.250") +0.051/+0.076 (mm) | 38.100 +0.051/+0.076 | 28.575 +/-0.127 | BP0318-0381-0286-BSHH1 |
| 31.750 (1.250") +0.064/+0.089 (mm) | 38.100 +0.076/+0.102 | 28.575 +/-0.127 | BP0318-0381-0286-BSHH2 |
| 31.750 (1.250") +0.076/+0.102 (mm) | 38.100 +0.076/+0.102 | 28.575 +/-0.127 | BP0318-0381-0286-BSHH3 |
| 31.750 (1.250") +0.025/+0.051 (mm) | 38.100 +0.025/+0.051 | 31.750 +/-0.127 | BP0318-0381-0318-BSTT |



Stocked or Short Delivery



Usually Available Short Delivery



Long delivery or not in current production

* Large Minimum Quantities

** Available only while stock lasts

Bushes - Plain

| Nominal ID (d) mm (inches) | Nominal OD (D) mm | Length (S) mm | Part Number |
|---------------------------------------|-------------------------|--------------------|-------------------------------|
| 31.750 (1.250") +0.051/+0.076 (mm) | 38.100 +0.051/+0.076 | 31.750 +/-0.127 | BP0318-0381-0318-BSHH1 |
| 31.750 (1.250") +0.064/+0.089 (mm) | 38.100 +0.076/+0.102 | 31.750 +/-0.127 | BP0318-0381-0318-BSHH2 |
| 31.750 (1.250") +0.076/+0.102 (mm) | 38.100 +0.076/+0.102 | 31.750 +/-0.127 | BP0318-0381-0318-BSHH3 |
| 31.750 (1.250") -0.025/+0.000 (mm) | 38.100 +0.025/+0.051 | 31.750 +/-0.127 | BP0318-0381-0318-BSUT |
| 31.750 (1.250") +0.025/+0.051 (mm) | 38.100 +0.025/+0.051 | 34.925 | BP0318-0381-0349-BSTT |
| 31.750 (1.250") +0.051/+0.076 (mm) | 38.100 +0.051/+0.076 | 34.925 +/-0.127 | BP0318-0381-0349-BSHH1 |
| 31.750 (1.250") +0.064/+0.089 (mm) | 38.100 +0.076/+0.102 | 34.925 +/-0.127 | BP0318-0381-0349-BSHH2 |
| 31.750 (1.250") +0.076/+0.102 (mm) | 38.100 +0.076/+0.102 | 34.925 +/-0.127 | BP0318-0381-0349-BSHH3 |
| 31.750 (1.250") +0.025/+0.051 (mm) | 38.100 +0.025/+0.051 | 38.100 +/-0.127 | BP0318-0381-0381-BSTT |
| 31.750 (1.250") +0.051/+0.076 (mm) | 38.100 +0.051/+0.076 | 38.100 +/-0.127 | BP0318-0381-0381-BSHH1 |
| 31.750 (1.250") +0.051/+0.076 (mm) | 38.100 +0.051/+0.076 | 38.100 +/-0.127 | BP0318-0381-0381-BSHH2 |
| 31.750 (1.250") +0.051/+0.076 (mm) | 38.100 +0.076/+0.102 | 38.100 +/-0.127 | BP0318-0381-0381-BSHH3 |
| 31.750 (1.250") +0.064/+0.089 (mm) | 38.100 +0.076/+0.102 | 38.100 +/-0.127 | BP0318-0381-0381-BSHH4 |
| 31.750 (1.250") +0.076/+0.102 (mm) | 38.100 +0.076/+0.102 | 38.100 +/-0.127 | BP0318-0381-0381-BSHH5 |
| 31.750 (1.250") +0.178/+0.203 (mm) | 38.100 +0.076/+0.102 | 38.100 +/-0.127 | BP0318-0381-0381-BSHH6 |
| 31.750 (1.250") +0.051/+0.076 (mm) | 38.100 +0.051/+0.076 | 41.275 +/-0.190 | BP0318-0381-0413-BSHH1 |
| 31.750 (1.250") +0.064/+0.089 (mm) | 38.100 +0.076/+0.102 | 41.275 +/-0.190 | BP0318-0381-0413-BSHH2 |
| 31.750 (1.250") +0.076/+0.102 (mm) | 38.100 +0.076/+0.102 | 41.275 +/-0.190 | BP0318-0381-0413-BSHH3 |
| 31.750 (1.250") -0.025/+0.000 (mm) | 38.100 +0.025/+0.051 | 41.275 | BP0318-0381-0413-BSUT |
| 31.750 (1.250") +0.025/+0.051 (mm) | 38.100 +0.025/+0.051 | 44.450 | BP0318-0381-0445-BSTT |
| 31.750 (1.250") +0.051/+0.076 (mm) | 38.100 +0.051/+0.076 | 44.450 +/-0.190 | BP0318-0381-0445-BSHH1 |
| 31.750 (1.250") +0.064/+0.089 (mm) | 38.100 +0.076/+0.102 | 44.450 +/-0.190 | BP0318-0381-0445-BSHH2 |
| 31.750 (1.250") +0.076/+0.102 (mm) | 38.100 +0.076/+0.102 | 44.450 +/-0.190 | BP0318-0381-0445-BSHH3 |
| 31.750 (1.250") +0.025/+0.051 (mm) | 38.100 +0.025/+0.051 | 47.625 | BP0318-0381-0476-BSTT |
| 31.750 (1.250") +0.064/+0.089 (mm) | 38.100 +0.076/+0.102 | 47.625 +/-0.190 | BP0318-0381-0476-BSHH1 |
| 31.750 (1.250") +0.076/+0.102 (mm) | 38.100 +0.076/+0.102 | 47.625 +/-0.190 | BP0318-0381-0476-BSHH2 |
| 31.750 (1.250") +0.025/+0.051 (mm) | 38.100 +0.025/+0.051 | 50.800 | BP0318-0381-0508-BSTT |
| 31.750 (1.250") +0.051/+0.076 (mm) | 38.100 +0.051/+0.076 | 50.800 +/-0.190 | BP0318-0381-0508-BSHH1 |
| 31.750 (1.250") +0.064/+0.089 (mm) | 38.100 +0.076/+0.102 | 50.800 +/-0.190 | BP0318-0381-0508-BSHH2 |
| 31.750 (1.250") +0.076/+0.102 (mm) | 38.100 +0.076/+0.102 | 50.800 +/-0.190 | BP0318-0381-0508-BSHH3 |
| 31.750 (1.250") +0.051/+0.076 (mm) | 38.100 +0.051/+0.076 | 56.896 +/-0.190 | BP0318-0381-0569-BSHH1 |
| 31.750 (1.250") +0.064/+0.089 (mm) | 38.100 +0.076/+0.102 | 56.896 +/-0.190 | BP0318-0381-0569-BSHH2 |
| 31.750 (1.250") +0.076/+0.102 (mm) | 38.100 +0.076/+0.102 | 57.150 +/-0.190 | BP0318-0381-0572-BSHH |
| 31.750 (1.250") +0.025/+0.051 (mm) | 38.100 +0.025/+0.051 | 63.500 | BP0318-0381-0635-BSTT |



Stocked or Short Delivery



Usually Available Short Delivery



Long delivery or not in current production

* Large Minimum Quantities

** Available only while stock lasts

Bushes - Plain

| Nominal ID (d) mm (inches) | Nominal OD (D) mm | Length (S) mm | Part Number |
|---------------------------------------|-------------------------|--------------------|-------------------------------|
| 31.750 (1.250") +0.064/+0.089 (mm) | 38.100 +0.076/+0.102 | 63.500 +/-0.190 | BP0318-0381-0635-BSHH1 |
| 31.750 (1.250") +0.076/+0.102 (mm) | 38.100 +0.076/+0.102 | 63.500 +/-0.190 | BP0318-0381-0635-BSHH2 |
| 31.750 (1.250") +0.051/+0.076 (mm) | 38.100 +0.051/+0.076 | 76.200 +/-0.190 | BP0318-0381-0762-BSHH1 |
| 31.750 (1.250") +0.064/+0.089 (mm) | 38.100 +0.076/+0.102 | 76.200 +/-0.190 | BP0318-0381-0762-BSHH2 |
| 31.750 (1.250") +0.076/+0.102 (mm) | 38.100 +0.076/+0.102 | 76.200 +/-0.190 | BP0318-0381-0762-BSHH3 |
| 31.750 (1.250") +0.076/+0.102 (mm) | 39.688 +0.051/+0.089 | 25.400 +/-0.127 | BP0318-0397-0254-BSHT |
| 31.750 (1.250") +0.025/+0.051 (mm) | 39.688 +0.025/+0.064 | 31.750 +/-0.127 | BP0318-0397-0318-BSTL |
| 31.750 (1.250") +0.025/+0.051 (mm) | 39.688 +0.025/+0.064 | 38.100 | BP0318-0397-0381-BSTL |
| 31.750 (1.250") +0.076/+0.102 (mm) | 39.688 +0.051/+0.089 | 38.100 +/-0.127 | BP0318-0397-0381-BSHT |
| 31.750 (1.250") +0.025/+0.051 (mm) | 39.688 +0.025/+0.064 | 44.450 +/-0.190 | BP0318-0397-0445-BSTL |
| 31.750 (1.250") +0.025/+0.051 (mm) | 39.688 +0.025/+0.064 | 50.800 | BP0318-0397-0508-BSTL |
| 31.750 (1.250") +0.076/+0.102 (mm) | 39.688 +0.051/+0.089 | 50.800 +/-0.190 | BP0318-0397-0508-BSHT |
| 31.750 (1.250") +0.025/+0.051 (mm) | 39.688 +0.025/+0.064 | 57.150 +/-0.190 | BP0318-0397-0572-BSTL |
| 31.750 (1.250") +0.025/+0.051 (mm) | 41.275 +0.025/+0.064 | 25.400 | BP0318-0413-0254-BSTL |
| 31.750 (1.250") +0.051/+0.076 (mm) | 41.275 +0.038/+0.076 | 25.400 +/-0.127 | BP0318-0413-0254-BSHT1 |
| 31.750 (1.250") +0.064/+0.089 (mm) | 41.275 +0.089/+0.127 | 25.400 +/-0.127 | BP0318-0413-0254-BSHH |
| 31.750 (1.250") +0.076/+0.102 (mm) | 41.275 +0.064/+0.102 | 25.400 +/-0.127 | BP0318-0413-0254-BSHT2 |
| 31.750 (1.250") +0.025/+0.051 (mm) | 41.275 +0.025/+0.064 | 31.750 | BP0318-0413-0318-BSTL |
| 31.750 (1.250") +0.051/+0.076 (mm) | 41.275 +0.038/+0.076 | 31.750 +/-0.127 | BP0318-0413-0318-BSHT1 |
| 31.750 (1.250") +0.064/+0.089 (mm) | 41.275 +0.089/+0.127 | 31.750 +/-0.127 | BP0318-0413-0318-BSHH |
| 31.750 (1.250") +0.076/+0.102 (mm) | 41.275 +0.064/+0.102 | 31.750 +/-0.127 | BP0318-0413-0318-BSHT2 |
| 31.750 (1.250") +0.025/+0.051 (mm) | 41.275 +0.025/+0.064 | 38.100 +/-0.127 | BP0318-0413-0381-BSTL |
| 31.750 (1.250") +0.051/+0.076 (mm) | 41.275 +0.038/+0.076 | 38.100 +/-0.127 | BP0318-0413-0381-BSHT1 |
| 31.750 (1.250") +0.064/+0.089 (mm) | 41.275 +0.089/+0.127 | 38.100 +/-0.127 | BP0318-0413-0381-BSHH |
| 31.750 (1.250") +0.076/+0.102 (mm) | 41.275 +0.064/+0.102 | 38.100 +/-0.127 | BP0318-0413-0381-BSHT2 |
| 31.750 (1.250") -0.025/+0.000 (mm) | 41.275 +0.013/+0.051 | 38.100 +/-0.127 | BP0318-0413-0381-BSUL |
| 31.750 (1.250") +0.025/+0.051 (mm) | 41.275 +0.025/+0.064 | 41.275 +/-0.190 | BP0318-0413-0413-BSTL |
| 31.750 (1.250") +0.025/+0.051 (mm) | 41.275 +0.025/+0.064 | 44.450 +/-0.190 | BP0318-0413-0445-BSTL |
| 31.750 (1.250") +0.051/+0.076 (mm) | 41.275 +0.038/+0.076 | 44.450 +/-0.190 | BP0318-0413-0445-BSHT1 |
| 31.750 (1.250") +0.064/+0.089 (mm) | 41.275 +0.089/+0.127 | 44.450 +/-0.190 | BP0318-0413-0445-BSHH |
| 31.750 (1.250") +0.076/+0.102 (mm) | 41.275 +0.064/+0.102 | 44.450 +/-0.190 | BP0318-0413-0445-BSHT2 |
| 31.750 (1.250") +0.025/+0.051 (mm) | 41.275 +0.025/+0.064 | 50.800 | BP0318-0413-0508-BSTL |
| 31.750 (1.250") +0.051/+0.076 (mm) | 41.275 +0.038/+0.076 | 50.800 +/-0.190 | BP0318-0413-0508-BSHT1 |
| 31.750 (1.250") +0.064/+0.089 (mm) | 41.275 +0.089/+0.127 | 50.800 +/-0.190 | BP0318-0413-0508-BSHH |

Stocked or Short Delivery
 Usually Available Short Delivery
 Long delivery or not in current production

* Large Minimum Quantities

** Available only while stock lasts

Bushes - Plain

| Nominal ID (d) mm (inches) | Nominal OD (D) mm | Length (S) mm | Part Number |
|---------------------------------------|-------------------------|--------------------|-------------------------------|
| 31.750 (1.250") +0.076/+0.102 (mm) | 41.275 +0.064/+0.102 | 50.800 +/-0.190 | BP0318-0413-0508-BSHT2 |
| 31.750 (1.250") +0.025/+0.051 (mm) | 41.275 +0.025/+0.064 | 63.500 | BP0318-0413-0635-BSTL |
| 31.750 (1.250") +0.051/+0.076 (mm) | 41.275 +0.038/+0.076 | 63.500 +/-0.190 | BP0318-0413-0635-BSHT1 |
| 31.750 (1.250") +0.064/+0.089 (mm) | 41.275 +0.089/+0.127 | 63.500 +/-0.190 | BP0318-0413-0635-BSHH |
| 31.750 (1.250") +0.076/+0.102 (mm) | 41.275 +0.064/+0.102 | 63.500 +/-0.190 | BP0318-0413-0635-BSHT2 |
| 31.750 (1.250") +0.025/+0.051 (mm) | 41.275 +0.025/+0.064 | 76.200 | BP0318-0413-0762-BSTL |
| 31.750 (1.250") +0.051/+0.076 (mm) | 41.275 +0.038/+0.076 | 76.200 +/-0.190 | BP0318-0413-0762-BSHT1 |
| 31.750 (1.250") +0.064/+0.089 (mm) | 41.275 +0.089/+0.127 | 76.200 +/-0.190 | BP0318-0413-0762-BSHH |
| 31.750 (1.250") +0.076/+0.102 (mm) | 41.275 +0.064/+0.102 | 76.200 +/-0.190 | BP0318-0413-0762-BSHT2 |
| 31.750 (1.250") +0.076/+0.102 (mm) | 44.450 +0.038/+0.076 | 38.100 | BP0318-0445-0381-BSHT1 |
| 31.750 (1.250") +0.076/+0.102 (mm) | 44.450 +0.064/+0.102 | 38.100 +/-0.127 | BP0318-0445-0381-BSHT2 |
| 31.750 (1.250") +0.064/+0.089 (mm) | 44.450 +0.089/+0.127 | 44.450 +/-0.190 | BP0318-0445-0445-BSHH |
| 31.750 (1.250") +0.076/+0.102 (mm) | 44.450 +0.064/+0.102 | 44.450 +/-0.190 | BP0318-0445-0445-BSHT |
| 31.750 (1.250") +0.064/+0.089 (mm) | 44.450 +0.089/+0.127 | 50.800 +/-0.190 | BP0318-0445-0508-BSHH |
| 31.750 (1.250") +0.076/+0.102 (mm) | 44.450 +0.038/+0.076 | 50.800 | BP0318-0445-0508-BSHT1 |
| 31.750 (1.250") +0.076/+0.102 (mm) | 44.450 +0.064/+0.102 | 50.800 +/-0.190 | BP0318-0445-0508-BSHT2 |
| 31.750 (1.250") +0.064/+0.089 (mm) | 44.450 +0.089/+0.127 | 63.500 +/-0.190 | BP0318-0445-0635-BSHH |
| 31.750 (1.250") +0.076/+0.102 (mm) | 44.450 +0.064/+0.102 | 63.500 +/-0.190 | BP0318-0445-0635-BSHT |
| 31.750 (1.250") +0.064/+0.089 (mm) | 44.450 +0.089/+0.127 | 76.200 +/-0.190 | BP0318-0445-0762-BSHH |
| 31.750 (1.250") +0.076/+0.102 (mm) | 44.450 +0.038/+0.076 | 76.200 | BP0318-0445-0762-BSHT1 |
| 31.750 (1.250") +0.076/+0.102 (mm) | 44.450 +0.064/+0.102 | 76.200 +/-0.190 | BP0318-0445-0762-BSHT2 |
| 32.000 (1.260") +0.009/+0.040 (mm) | 38.000 +0.040/+0.070 | 20.000 +/-0.120 | BP0320-0380-0200-BSLT |
| 32.000 (1.260") +0.009/+0.040 (mm) | 38.000 +0.040/+0.070 | 25.000 +/-0.120 | BP0320-0380-0250-BSLT |
| 32.000 (1.260") +0.009/+0.040 (mm) | 38.000 +0.040/+0.070 | 28.000 +/-0.120 | BP0320-0380-0280-BSLT |
| 32.000 (1.260") +0.009/+0.040 (mm) | 38.000 +0.040/+0.070 | 32.000 +/-0.120 | BP0320-0380-0320-BSLT |
| 32.000 (1.260") +0.009/+0.040 (mm) | 38.000 +0.040/+0.070 | 40.000 +/-0.190 | BP0320-0380-0400-BSLT |
| 32.000 (1.260") +0.009/+0.040 (mm) | 38.000 +0.040/+0.070 | 50.000 +/-0.190 | BP0320-0380-0500-BSLT |
| 32.000 (1.260") +0.009/+0.040 (mm) | 40.000 +0.040/+0.070 | 20.000 +/-0.120 | BP0320-0400-0200-BSLT |
| 32.000 (1.260") +0.009/+0.040 (mm) | 40.000 +0.040/+0.070 | 25.000 +/-0.120 | BP0320-0400-0250-BSLT |
| 32.000 (1.260") +0.009/+0.040 (mm) | 40.000 +0.040/+0.070 | 32.000 +/-0.120 | BP0320-0400-0320-BSLT |
| 32.000 (1.260") +0.009/+0.040 (mm) | 40.000 +0.040/+0.070 | 40.000 +/-0.190 | BP0320-0400-0400-BSLT |
| 32.000 (1.260") +0.009/+0.040 (mm) | 40.000 +0.040/+0.070 | 50.000 +/-0.190 | BP0320-0400-0500-BSLT |
| 33.338 (1.313") +0.051/+0.076 (mm) | 38.100 +0.051/+0.076 | 25.400 +/-0.127 | BP0333-0381-0254-BSHH |
| 33.338 (1.313") +0.051/+0.076 (mm) | 38.100 +0.051/+0.076 | 31.750 +/-0.127 | BP0333-0381-0318-BSHH |



Stocked or Short Delivery



Usually Available Short Delivery



Long delivery or not in current production

* Large Minimum Quantities

** Available only while stock lasts

Bushes - Plain

| Nominal ID (d) mm (inches) | Nominal OD (D) mm | Length (S) mm | Part Number |
|---------------------------------------|-------------------------|--------------------|-------------------------------|
| 33.338 (1.313") +0.051/+0.076 (mm) | 38.100 +0.051/+0.076 | 38.100 +/-0.127 | BP0333-0381-0381-BSHH |
| 33.338 (1.313") +0.051/+0.076 (mm) | 38.100 +0.051/+0.076 | 50.800 +/-0.190 | BP0333-0381-0508-BSHH |
| 33.338 (1.313") +0.064/+0.089 (mm) | 39.688 +0.051/+0.089 | 25.400 +/-0.127 | * BP0333-0397-0254-BSHT |
| 33.338 (1.313") +0.064/+0.089 (mm) | 39.688 +0.051/+0.089 | 38.100 +/-0.127 | * BP0333-0397-0381-BSHT |
| 33.338 (1.313") +0.064/+0.089 (mm) | 39.688 +0.051/+0.089 | 50.800 +/-0.190 | * BP0333-0397-0508-BSHT |
| 33.338 (1.313") +0.051/+0.076 (mm) | 41.275 +0.038/+0.076 | 31.750 +/-0.127 | BP0333-0413-0318-BSHT1 |
| 33.338 (1.313") +0.064/+0.089 (mm) | 41.275 +0.064/+0.102 | 31.750 +/-0.127 | BP0333-0413-0318-BSHT2 |
| 33.338 (1.313") +0.064/+0.089 (mm) | 41.275 +0.089/+0.127 | 31.750 +/-0.127 | BP0333-0413-0318-BSHH |
| 33.338 (1.313") +0.051/+0.076 (mm) | 41.275 +0.038/+0.076 | 38.100 +/-0.127 | BP0333-0413-0381-BSHT1 |
| 33.338 (1.313") +0.051/+0.076 (mm) | 41.275 +0.064/+0.102 | 38.100 +/-0.127 | BP0333-0413-0381-BSHT2 |
| 33.338 (1.313") +0.064/+0.089 (mm) | 41.275 +0.064/+0.102 | 38.100 +/-0.127 | BP0333-0413-0381-BSHT3 |
| 33.338 (1.313") +0.064/+0.089 (mm) | 41.275 +0.089/+0.127 | 38.100 +/-0.127 | BP0333-0413-0381-BSHH |
| 33.338 (1.313") +0.051/+0.076 (mm) | 41.275 +0.038/+0.076 | 50.800 +/-0.190 | BP0333-0413-0508-BSHT1 |
| 33.338 (1.313") +0.051/+0.076 (mm) | 41.275 +0.064/+0.102 | 50.800 +/-0.190 | BP0333-0413-0508-BSHT2 |
| 33.338 (1.313") +0.064/+0.089 (mm) | 41.275 +0.064/+0.102 | 50.800 +/-0.190 | BP0333-0413-0508-BSHT3 |
| 33.338 (1.313") +0.064/+0.089 (mm) | 41.275 +0.089/+0.127 | 50.800 +/-0.190 | BP0333-0413-0508-BSHH |
| 33.338 (1.313") +0.051/+0.076 (mm) | 41.275 +0.038/+0.076 | 63.500 +/-0.190 | BP0333-0413-0635-BSHT1 |
| 33.338 (1.313") +0.051/+0.076 (mm) | 41.275 +0.064/+0.102 | 63.500 +/-0.190 | BP0333-0413-0635-BSHT2 |
| 33.338 (1.313") +0.064/+0.089 (mm) | 41.275 +0.064/+0.102 | 63.500 +/-0.190 | BP0333-0413-0635-BSHT3 |
| 33.338 (1.313") +0.064/+0.089 (mm) | 41.275 +0.089/+0.127 | 63.500 +/-0.190 | BP0333-0413-0635-BSHH |
| 33.338 (1.313") +0.051/+0.076 (mm) | 41.275 +0.038/+0.076 | 76.200 +/-0.190 | BP0333-0413-0762-BSHT1 |
| 33.338 (1.313") +0.064/+0.089 (mm) | 41.275 +0.064/+0.102 | 76.200 +/-0.190 | BP0333-0413-0762-BSHT2 |
| 33.338 (1.313") +0.064/+0.089 (mm) | 41.275 +0.089/+0.127 | 76.200 +/-0.190 | BP0333-0413-0762-BSHH |
| 34.925 (1.375") -0.038/-0.013 (mm) | 39.688 +0.038/+0.076 | 31.750 +/-0.127 | BP0349-0397-0318-BSUT |
| 34.925 (1.375") -0.038/-0.013 (mm) | 39.688 +0.038/+0.076 | 38.100 +/-0.127 | BP0349-0397-0381-BSUT |
| 34.925 (1.375") +0.000/+0.025 (mm) | 41.275 +0.038/+0.076 | 25.400 | BP0349-0413-0254-BSLT |
| 34.925 (1.375") +0.051/+0.076 (mm) | 41.275 +0.038/+0.076 | 25.400 +/-0.127 | BP0349-0413-0254-BSHT1 |
| 34.925 (1.375") +0.064/+0.089 (mm) | 41.275 +0.089/+0.127 | 25.400 +/-0.127 | BP0349-0413-0254-BSHH |
| 34.925 (1.375") +0.076/+0.102 (mm) | 41.275 +0.064/+0.102 | 25.400 +/-0.127 | BP0349-0413-0254-BSHT2 |
| 34.925 (1.375") +0.000/+0.025 (mm) | 41.275 +0.038/+0.076 | 28.575 | BP0349-0413-0286-BSLT |
| 34.925 (1.375") +0.064/+0.089 (mm) | 41.275 +0.089/+0.127 | 28.575 +/-0.127 | BP0349-0413-0286-BSHH |
| 34.925 (1.375") +0.076/+0.102 (mm) | 41.275 +0.064/+0.102 | 28.575 +/-0.127 | BP0349-0413-0286-BSHT |
| 34.925 (1.375") +0.000/+0.025 (mm) | 41.275 +0.038/+0.076 | 31.750 | BP0349-0413-0318-BSLT |
| 34.925 (1.375") +0.064/+0.089 (mm) | 41.275 +0.089/+0.127 | 31.750 +/-0.127 | BP0349-0413-0318-BSHH |



Stocked or Short Delivery



Usually Available Short Delivery



Long delivery or not in current production

* Large Minimum Quantities

** Available only while stock lasts

Bushes - Plain

| Nominal ID (d) mm (inches) | Nominal OD (D) mm | Length (S) mm | Part Number |
|---------------------------------------|-------------------------|--------------------|-------------------------------|
| 34.925 (1.375") +0.076/+0.102 (mm) | 41.275 +0.064/+0.102 | 31.750 +/-0.127 | BP0349-0413-0318-BSHT |
| 34.925 (1.375") +0.000/+0.025 (mm) | 41.275 +0.038/+0.076 | 38.100 +/-0.127 | BP0349-0413-0381-BSLT |
| 34.925 (1.375") +0.051/+0.076 (mm) | 41.275 +0.038/+0.076 | 38.100 +/-0.127 | BP0349-0413-0381-BSHT |
| 34.925 (1.375") +0.064/+0.089 (mm) | 41.275 +0.089/+0.127 | 38.100 +/-0.127 | BP0349-0413-0381-BSHH |
| 34.925 (1.375") +0.076/+0.102 (mm) | 41.275 +0.038/+0.076 | 38.100 +/-0.127 | BP0349-0413-0381-BSHT1 |
| 34.925 (1.375") +0.076/+0.102 (mm) | 41.275 +0.064/+0.102 | 38.100 +/-0.127 | BP0349-0413-0381-BSHT2 |
| 34.925 (1.375") +0.000/+0.025 (mm) | 41.275 +0.038/+0.076 | 44.450 +/-0.190 | BP0349-0413-0445-BSLT |
| 34.925 (1.375") +0.000/+0.025 (mm) | 41.275 +0.038/+0.076 | 50.800 +/-0.190 | BP0349-0413-0508-BSLT |
| 34.925 (1.375") +0.051/+0.076 (mm) | 41.275 +0.038/+0.076 | 50.800 +/-0.190 | BP0349-0413-0508-BSHT |
| 34.925 (1.375") +0.064/+0.089 (mm) | 41.275 +0.089/+0.127 | 50.800 +/-0.190 | BP0349-0413-0508-BSHH |
| 34.925 (1.375") +0.076/+0.102 (mm) | 41.275 +0.038/+0.076 | 50.800 +/-0.190 | BP0349-0413-0508-BSHT1 |
| 34.925 (1.375") +0.076/+0.102 (mm) | 41.275 +0.064/+0.102 | 50.800 +/-0.190 | BP0349-0413-0508-BSHT2 |
| 34.925 (1.375") +0.000/+0.025 (mm) | 41.275 +0.038/+0.076 | 63.500 +/-0.190 | BP0349-0413-0635-BSLT |
| 34.925 (1.375") +0.051/+0.076 (mm) | 41.275 +0.038/+0.076 | 63.500 +/-0.190 | BP0349-0413-0635-BSHT |
| 34.925 (1.375") +0.064/+0.089 (mm) | 41.275 +0.089/+0.127 | 63.500 +/-0.190 | BP0349-0413-0635-BSHH |
| 34.925 (1.375") +0.076/+0.102 (mm) | 41.275 +0.038/+0.076 | 63.500 +/-0.190 | BP0349-0413-0635-BSHT1 |
| 34.925 (1.375") +0.076/+0.102 (mm) | 41.275 +0.064/+0.102 | 63.500 +/-0.190 | BP0349-0413-0635-BSHT2 |
| 34.925 (1.375") +0.051/+0.076 (mm) | 41.275 +0.038/+0.076 | 76.200 +/-0.190 | BP0349-0413-0762-BSHT1 |
| 34.925 (1.375") +0.064/+0.089 (mm) | 41.275 +0.089/+0.127 | 76.200 +/-0.190 | BP0349-0413-0762-BSHH |
| 34.925 (1.375") +0.076/+0.102 (mm) | 41.275 +0.064/+0.102 | 76.200 +/-0.190 | BP0349-0413-0762-BSHT2 |
| 34.925 (1.375") +0.051/+0.076 (mm) | 44.450 +0.038/+0.076 | 25.400 +/-0.127 | BP0349-0445-0254-BSHT1 |
| 34.925 (1.375") +0.064/+0.089 (mm) | 44.450 +0.089/+0.127 | 25.400 +/-0.127 | BP0349-0445-0254-BSHH |
| 34.925 (1.375") +0.076/+0.102 (mm) | 44.450 +0.064/+0.102 | 25.400 +/-0.127 | BP0349-0445-0254-BSHT2 |
| 34.925 (1.375") +0.051/+0.076 (mm) | 44.450 +0.038/+0.076 | 38.100 +/-0.127 | BP0349-0445-0381-BSHT |
| 34.925 (1.375") +0.064/+0.089 (mm) | 44.450 +0.089/+0.127 | 38.100 +/-0.127 | BP0349-0445-0381-BSHH |
| 34.925 (1.375") +0.076/+0.102 (mm) | 44.450 +0.064/+0.102 | 38.100 +/-0.127 | BP0349-0445-0381-BSHT1 |
| 34.925 (1.375") +0.102/+0.127 (mm) | 44.450 +0.038/+0.076 | 38.100 +/-0.127 | BP0349-0445-0381-BSHT2 |
| 34.925 (1.375") +0.051/+0.076 (mm) | 44.450 +0.038/+0.076 | 50.800 +/-0.190 | BP0349-0445-0508-BSHT |
| 34.925 (1.375") +0.064/+0.089 (mm) | 44.450 +0.089/+0.127 | 50.800 +/-0.190 | BP0349-0445-0508-BSHH |
| 34.925 (1.375") +0.076/+0.102 (mm) | 44.450 +0.064/+0.102 | 50.800 +/-0.190 | BP0349-0445-0508-BSHT1 |
| 34.925 (1.375") +0.102/+0.127 (mm) | 44.450 +0.038/+0.076 | 50.800 +/-0.190 | BP0349-0445-0508-BSHT2 |
| 34.925 (1.375") +0.051/+0.076 (mm) | 44.450 +0.038/+0.076 | 63.500 +/-0.190 | BP0349-0445-0635-BSHT |
| 34.925 (1.375") +0.064/+0.089 (mm) | 44.450 +0.089/+0.127 | 63.500 +/-0.190 | BP0349-0445-0635-BSHH |
| 34.925 (1.375") +0.076/+0.102 (mm) | 44.450 +0.064/+0.102 | 63.500 +/-0.190 | BP0349-0445-0635-BSHT1 |



Stocked or Short Delivery



Usually Available Short Delivery



Long delivery or not in current production

* Large Minimum Quantities

** Available only while stock lasts

Bushes - Plain

| Nominal ID (d) mm (inches) | Nominal OD (D) mm | Length (S) mm | Part Number |
|---------------------------------------|-------------------------|--------------------|-------------------------------|
| 34.925 (1.375") +0.102/+0.127 (mm) | 44.450 +0.038/+0.076 | 63.500 | BP0349-0445-0635-BSHT2 |
| 34.925 (1.375") +0.051/+0.076 (mm) | 44.450 +0.038/+0.076 | 76.200 +/-0.190 | BP0349-0445-0762-BSHT1 |
| 34.925 (1.375") +0.064/+0.089 (mm) | 44.450 +0.089/+0.127 | 76.200 +/-0.190 | BP0349-0445-0762-BSHH |
| 34.925 (1.375") +0.076/+0.102 (mm) | 44.450 +0.064/+0.102 | 76.200 +/-0.190 | BP0349-0445-0762-BSHT2 |
| 35.000 (1.378") +0.009/+0.040 (mm) | 44.000 +0.040/+0.070 | 22.000 +/-0.120 | BP0350-0440-0220-BSLT |
| 35.000 (1.378") +0.009/+0.040 (mm) | 44.000 +0.040/+0.070 | 28.000 +/-0.120 | BP0350-0440-0280-BSLT |
| 35.000 (1.378") +0.009/+0.040 (mm) | 44.000 +0.040/+0.070 | 35.000 +/-0.120 | BP0350-0440-0350-BSLT |
| 35.000 (1.378") +0.009/+0.040 (mm) | 45.000 +0.040/+0.070 | 25.000 +/-0.120 | BP0350-0450-0250-BSLT |
| 35.000 (1.378") +0.009/+0.040 (mm) | 45.000 +0.040/+0.070 | 35.000 +/-0.120 | BP0350-0450-0350-BSLT |
| 35.000 (1.378") +0.009/+0.040 (mm) | 45.000 +0.040/+0.070 | 40.000 +/-0.190 | BP0350-0450-0400-BSLT |
| 35.000 (1.378") +0.009/+0.040 (mm) | 45.000 +0.040/+0.070 | 45.000 +/-0.190 | BP0350-0450-0450-BSLT |
| 35.000 (1.378") +0.009/+0.040 (mm) | 45.000 +0.040/+0.070 | 50.000 +/-0.190 | BP0350-0450-0500-BSLT |
| 36.000 (1.417") +0.009/+0.040 (mm) | 42.000 +0.040/+0.070 | 22.000 +/-0.120 | BP0360-0420-0220-BSLT |
| 36.000 (1.417") +0.009/+0.040 (mm) | 42.000 +0.040/+0.070 | 28.000 +/-0.120 | BP0360-0420-0280-BSLT |
| 36.000 (1.417") +0.009/+0.040 (mm) | 42.000 +0.040/+0.070 | 36.000 +/-0.120 | BP0360-0420-0360-BSLT |
| 36.000 (1.417") +0.009/+0.040 (mm) | 42.000 +0.040/+0.070 | 45.000 +/-0.190 | BP0360-0420-0450-BSLT |
| 36.000 (1.417") +0.009/+0.040 (mm) | 45.000 +0.040/+0.070 | 22.000 +/-0.120 | BP0360-0450-0220-BSLT |
| 36.000 (1.417") +0.009/+0.040 (mm) | 45.000 +0.040/+0.070 | 28.000 +/-0.120 | BP0360-0450-0280-BSLT |
| 36.000 (1.417") +0.009/+0.040 (mm) | 45.000 +0.040/+0.070 | 36.000 +/-0.120 | BP0360-0450-0360-BSLT |
| 36.000 (1.417") +0.009/+0.040 (mm) | 45.000 +0.040/+0.070 | 45.000 +/-0.190 | BP0360-0450-0450-BSLT |
| 36.513 (1.438") +/-0.013 (mm) | 41.275 +0.038/+0.076 | 25.400 | BP0365-0413-0254-BSUT |
| 36.513 (1.438") +0.064/+0.089 (mm) | 41.275 +0.089/+0.127 | 25.400 +/-0.127 | BP0365-0413-0254-BSHH |
| 36.513 (1.438") +0.089/+0.114 (mm) | 41.275 +0.064/+0.102 | 25.400 +/-0.127 | BP0365-0413-0254-BSHT |
| 36.513 (1.438") +/-0.013 (mm) | 41.275 +0.038/+0.076 | 38.100 | BP0365-0413-0381-BSUT |
| 36.513 (1.438") +0.064/+0.089 (mm) | 41.275 +0.089/+0.127 | 38.100 +/-0.127 | BP0365-0413-0381-BSHH |
| 36.513 (1.438") +0.089/+0.114 (mm) | 41.275 +0.064/+0.102 | 38.100 +/-0.127 | BP0365-0413-0381-BSHT |
| 36.513 (1.438") +/-0.013 (mm) | 41.275 +0.038/+0.076 | 50.800 | BP0365-0413-0508-BSUT |
| 36.513 (1.438") +0.064/+0.089 (mm) | 41.275 +0.089/+0.127 | 50.800 +/-0.190 | BP0365-0413-0508-BSHH |
| 36.513 (1.438") +0.089/+0.114 (mm) | 41.275 +0.064/+0.102 | 50.800 +/-0.190 | BP0365-0413-0508-BSHT |
| 36.513 (1.438") +/-0.013 (mm) | 41.275 +0.038/+0.076 | 57.150 | BP0365-0413-0572-BSUT |
| 36.513 (1.438") +0.089/+0.114 (mm) | 44.450 +0.064/+0.102 | 19.050 +/-0.127 | BP0365-0445-0191-BSHT |
| 36.513 (1.438") +0.102/+0.127 (mm) | 44.450 +0.051/+0.089 | 22.225 +/-0.127 | BP0365-0445-0222-BSHT |
| 36.513 (1.438") +0.051/+0.076 (mm) | 44.450 +0.038/+0.076 | 25.400 +/-0.127 | BP0365-0445-0254-BSHT1 |
| 36.513 (1.438") +0.064/+0.089 (mm) | 44.450 +0.089/+0.127 | 25.400 +/-0.127 | BP0365-0445-0254-BSHH |



Stocked or Short Delivery



Usually Available Short Delivery



Long delivery or not in current production

* Large Minimum Quantities

** Available only while stock lasts

Bushes - Plain

| Nominal ID (d) mm (inches) | Nominal OD (D) mm | Length (S) mm | Part Number |
|---------------------------------------|-------------------------|--------------------|-------------------------------|
| 36.513 (1.438") +0.089/+0.114 (mm) | 44.450 +0.064/+0.102 | 25.400 +/-0.127 | BP0365-0445-0254-BSHT2 |
| 36.513 (1.438") +0.102/+0.127 (mm) | 44.450 +0.051/+0.089 | 28.575 +/-0.127 | BP0365-0445-0286-BSHT |
| 36.513 (1.438") +0.051/+0.076 (mm) | 44.450 +0.038/+0.076 | 31.750 +/-0.127 | BP0365-0445-0318-BSHT |
| 36.513 (1.438") +0.064/+0.089 (mm) | 44.450 +0.089/+0.127 | 31.750 +/-0.127 | BP0365-0445-0318-BSHH |
| 36.513 (1.438") +0.089/+0.114 (mm) | 44.450 +0.064/+0.102 | 31.750 +/-0.127 | BP0365-0445-0318-BSHT1 |
| 36.513 (1.438") +0.102/+0.127 (mm) | 44.450 +0.051/+0.089 | 31.750 | BP0365-0445-0318-BSHT2 |
| 36.513 (1.438") +0.051/+0.076 (mm) | 44.450 +0.038/+0.076 | 38.100 +/-0.127 | BP0365-0445-0381-BSHT |
| 36.513 (1.438") +0.064/+0.089 (mm) | 44.450 +0.089/+0.127 | 38.100 +/-0.127 | BP0365-0445-0381-BSHH |
| 36.513 (1.438") +0.089/+0.114 (mm) | 44.450 +0.064/+0.102 | 38.100 +/-0.127 | BP0365-0445-0381-BSHT1 |
| 36.513 (1.438") +0.102/+0.127 (mm) | 44.450 +0.051/+0.089 | 38.100 +/-0.127 | BP0365-0445-0381-BSHT2 |
| 36.513 (1.438") +0.051/+0.076 (mm) | 44.450 +0.038/+0.076 | 44.450 +/-0.190 | BP0365-0445-0445-BSHT |
| 36.513 (1.438") +0.064/+0.089 (mm) | 44.450 +0.089/+0.127 | 44.450 +/-0.190 | BP0365-0445-0445-BSHH |
| 36.513 (1.438") +0.089/+0.114 (mm) | 44.450 +0.064/+0.102 | 44.450 +/-0.190 | BP0365-0445-0445-BSHT1 |
| 36.513 (1.438") +0.102/+0.127 (mm) | 44.450 +0.051/+0.089 | 44.450 | BP0365-0445-0445-BSHT2 |
| 36.513 (1.438") +0.102/+0.127 (mm) | 44.450 +0.051/+0.089 | 47.625 +/-0.190 | BP0365-0445-0476-BSHT |
| 36.513 (1.438") +0.051/+0.076 (mm) | 44.450 +0.038/+0.076 | 50.800 +/-0.190 | BP0365-0445-0508-BSHT |
| 36.513 (1.438") +0.064/+0.089 (mm) | 44.450 +0.089/+0.127 | 50.800 +/-0.190 | BP0365-0445-0508-BSHH |
| 36.513 (1.438") +0.089/+0.114 (mm) | 44.450 +0.064/+0.102 | 50.800 +/-0.190 | BP0365-0445-0508-BSHT1 |
| 36.513 (1.438") +0.102/+0.127 (mm) | 44.450 +0.051/+0.089 | 50.800 | BP0365-0445-0508-BSHT2 |
| 36.513 (1.438") +0.102/+0.127 (mm) | 44.450 +0.051/+0.089 | 57.150 +/-0.190 | BP0365-0445-0572-BSHT |
| 36.513 (1.438") +0.051/+0.076 (mm) | 44.450 +0.038/+0.076 | 63.500 +/-0.190 | BP0365-0445-0635-BSHT |
| 36.513 (1.438") +0.064/+0.089 (mm) | 44.450 +0.089/+0.127 | 63.500 +/-0.190 | BP0365-0445-0635-BSHH |
| 36.513 (1.438") +0.089/+0.114 (mm) | 44.450 +0.064/+0.102 | 63.500 +/-0.190 | BP0365-0445-0635-BSHT1 |
| 36.513 (1.438") +0.102/+0.127 (mm) | 44.450 +0.051/+0.089 | 63.500 | BP0365-0445-0635-BSHT2 |
| 36.513 (1.438") +0.051/+0.076 (mm) | 44.450 +0.038/+0.076 | 76.200 +/-0.190 | BP0365-0445-0762-BSHT1 |
| 36.513 (1.438") +0.064/+0.089 (mm) | 44.450 +0.089/+0.127 | 76.200 +/-0.190 | BP0365-0445-0762-BSHH |
| 36.513 (1.438") +0.089/+0.114 (mm) | 44.450 +0.064/+0.102 | 76.200 +/-0.190 | BP0365-0445-0762-BSHT2 |
| 38.000 (1.496") +0.009/+0.040 (mm) | 44.000 +0.040/+0.070 | 25.000 +/-0.120 | BP0380-0440-0250-BSLT |
| 38.000 (1.496") +0.009/+0.040 (mm) | 44.000 +0.040/+0.070 | 35.000 +/-0.120 | BP0380-0440-0350-BSLT |
| 38.000 (1.496") +0.009/+0.040 (mm) | 44.000 +0.040/+0.070 | 45.000 +/-0.190 | BP0380-0440-0450-BSLT |
| 38.100 (1.500") +0.152/+0.178 (mm) | 42.863 +0.051/+0.089 | 19.050 +/-0.127 | BP0381-0429-0191-BSHT |
| 38.100 (1.500") +0.152/+0.178 (mm) | 42.863 +0.051/+0.089 | 25.400 +/-0.127 | BP0381-0429-0254-BSHT |
| 38.100 (1.500") +0.051/+0.076 (mm) | 44.450 +0.064/+0.102 | 12.700 | BP0381-0445-0127-BSHT1 |
| 38.100 (1.500") +0.076/+0.102 (mm) | 44.450 +0.064/+0.102 | 12.700 +/-0.127 | BP0381-0445-0127-BSHT2 |



Stocked or Short Delivery



Usually Available Short Delivery



Long delivery or not in current production

* Large Minimum Quantities

** Available only while stock lasts

Bushes - Plain

| Nominal ID (d) mm (inches) | Nominal OD (D) mm | Length (S) mm | Part Number |
|---------------------------------------|-------------------------|--------------------|-------------------------------|
| 38.100 (1.500") +0.076/+0.102 (mm) | 44.450 +0.089/+0.127 | 12.700 +/-0.127 | BP0381-0445-0127-BSHH |
| 38.100 (1.500") +0.051/+0.076 (mm) | 44.450 +0.064/+0.102 | 15.875 +/-0.127 | BP0381-0445-0159-BSHT |
| 38.100 (1.500") +0.076/+0.102 (mm) | 44.450 +0.089/+0.127 | 15.875 +/-0.127 | BP0381-0445-0159-BSHH |
| 38.100 (1.500") +0.051/+0.076 (mm) | 44.450 +0.064/+0.102 | 19.050 | BP0381-0445-0191-BSHT1 |
| 38.100 (1.500") +0.076/+0.102 (mm) | 44.450 +0.064/+0.102 | 19.050 +/-0.127 | BP0381-0445-0191-BSHT2 |
| 38.100 (1.500") +0.076/+0.102 (mm) | 44.450 +0.089/+0.127 | 19.050 +/-0.127 | BP0381-0445-0191-BSHH |
| 38.100 (1.500") +0.051/+0.076 (mm) | 44.450 +0.064/+0.102 | 22.225 +/-0.127 | BP0381-0445-0222-BSHT |
| 38.100 (1.500") +0.076/+0.102 (mm) | 44.450 +0.089/+0.127 | 22.225 +/-0.127 | BP0381-0445-0222-BSHH |
| 38.100 (1.500") +0.051/+0.076 (mm) | 44.450 +0.038/+0.076 | 25.400 +/-0.127 | BP0381-0445-0254-BSHT1 |
| 38.100 (1.500") +0.051/+0.076 (mm) | 44.450 +0.064/+0.102 | 25.400 +/-0.127 | BP0381-0445-0254-BSHT2 |
| 38.100 (1.500") +0.076/+0.102 (mm) | 44.450 +0.064/+0.102 | 25.400 +/-0.127 | BP0381-0445-0254-BSHT3 |
| 38.100 (1.500") +0.076/+0.102 (mm) | 44.450 +0.089/+0.127 | 25.400 +/-0.127 | BP0381-0445-0254-BSHH |
| 38.100 (1.500") +0.051/+0.076 (mm) | 44.450 +0.064/+0.102 | 28.575 +/-0.127 | BP0381-0445-0286-BSHT |
| 38.100 (1.500") +0.051/+0.076 (mm) | 44.450 +0.038/+0.076 | 31.750 +/-0.127 | BP0381-0445-0318-BSHT1 |
| 38.100 (1.500") +0.051/+0.076 (mm) | 44.450 +0.064/+0.102 | 31.750 | BP0381-0445-0318-BSHT2 |
| 38.100 (1.500") +0.076/+0.102 (mm) | 44.450 +0.064/+0.102 | 31.750 +/-0.127 | BP0381-0445-0318-BSHT3 |
| 38.100 (1.500") +0.076/+0.102 (mm) | 44.450 +0.089/+0.127 | 31.750 +/-0.127 | BP0381-0445-0318-BSHH |
| 38.100 (1.500") +0.051/+0.076 (mm) | 44.450 +0.064/+0.102 | 34.925 | BP0381-0445-0349-BSHT1 |
| 38.100 (1.500") +0.076/+0.102 (mm) | 44.450 +0.064/+0.102 | 34.925 +/-0.127 | BP0381-0445-0349-BSHT2 |
| 38.100 (1.500") +0.076/+0.102 (mm) | 44.450 +0.089/+0.127 | 34.925 +/-0.127 | BP0381-0445-0349-BSHH |
| 38.100 (1.500") +0.051/+0.076 (mm) | 44.450 +0.038/+0.076 | 38.100 +/-0.127 | BP0381-0445-0381-BSHT1 |
| 38.100 (1.500") +0.051/+0.076 (mm) | 44.450 +0.064/+0.102 | 38.100 +/-0.127 | BP0381-0445-0381-BSHT2 |
| 38.100 (1.500") +0.076/+0.102 (mm) | 44.450 +0.064/+0.102 | 38.100 +/-0.127 | BP0381-0445-0381-BSHT3 |
| 38.100 (1.500") +0.076/+0.102 (mm) | 44.450 +0.089/+0.127 | 38.100 +/-0.127 | BP0381-0445-0381-BSHH |
| 38.100 (1.500") +0.051/+0.076 (mm) | 44.450 +0.064/+0.102 | 44.450 | BP0381-0445-0445-BSHT1 |
| 38.100 (1.500") +0.076/+0.102 (mm) | 44.450 +0.064/+0.102 | 44.450 +/-0.190 | BP0381-0445-0445-BSHT2 |
| 38.100 (1.500") +0.076/+0.102 (mm) | 44.450 +0.089/+0.127 | 44.450 +/-0.190 | BP0381-0445-0445-BSHH |
| 38.100 (1.500") +0.051/+0.076 (mm) | 44.450 +0.038/+0.076 | 50.800 +/-0.190 | BP0381-0445-0508-BSHT1 |
| 38.100 (1.500") +0.051/+0.076 (mm) | 44.450 +0.064/+0.102 | 50.800 +/-0.190 | BP0381-0445-0508-BSHT2 |
| 38.100 (1.500") +0.076/+0.102 (mm) | 44.450 +0.064/+0.102 | 50.800 +/-0.190 | BP0381-0445-0508-BSHT3 |
| 38.100 (1.500") +0.076/+0.102 (mm) | 44.450 +0.089/+0.127 | 50.800 +/-0.190 | BP0381-0445-0508-BSHH |
| 38.100 (1.500") +0.051/+0.076 (mm) | 44.450 +0.064/+0.102 | 57.150 | BP0381-0445-0572-BSHT1 |
| 38.100 (1.500") +0.076/+0.102 (mm) | 44.450 +0.064/+0.102 | 57.150 +/-0.190 | BP0381-0445-0572-BSHT2 |
| 38.100 (1.500") +0.076/+0.102 (mm) | 44.450 +0.089/+0.127 | 57.150 +/-0.190 | BP0381-0445-0572-BSHH |



Stocked or Short Delivery



Usually Available Short Delivery



Long delivery or not in current production

* Large Minimum Quantities

** Available only while stock lasts

Bushes - Plain

| Nominal ID (d) mm (inches) | Nominal OD (D) mm | Length (S) mm | Part Number |
|---------------------------------------|-------------------------|--------------------|-------------------------------|
| 38.100 (1.500") +0.051/+0.076 (mm) | 44.450 +0.038/+0.076 | 63.500 +/-0.190 | BP0381-0445-0635-BSHT1 |
| 38.100 (1.500") +0.051/+0.076 (mm) | 44.450 +0.064/+0.102 | 63.500 | BP0381-0445-0635-BSHT2 |
| 38.100 (1.500") +0.076/+0.102 (mm) | 44.450 +0.064/+0.102 | 63.500 +/-0.190 | BP0381-0445-0635-BSHT3 |
| 38.100 (1.500") +0.076/+0.102 (mm) | 44.450 +0.089/+0.127 | 63.500 +/-0.190 | BP0381-0445-0635-BSHH |
| 38.100 (1.500") +0.051/+0.076 (mm) | 44.450 +0.038/+0.076 | 76.200 +/-0.190 | BP0381-0445-0762-BSHT1 |
| 38.100 (1.500") +0.051/+0.076 (mm) | 44.450 +0.064/+0.102 | 76.200 | BP0381-0445-0762-BSHT2 |
| 38.100 (1.500") +0.076/+0.102 (mm) | 44.450 +0.064/+0.102 | 76.200 +/-0.190 | BP0381-0445-0762-BSHT3 |
| 38.100 (1.500") +0.076/+0.102 (mm) | 44.450 +0.089/+0.127 | 76.200 +/-0.190 | BP0381-0445-0762-BSHH |
| 38.100 (1.500") +0.051/+0.076 (mm) | 44.450 +0.064/+0.102 | 88.900 +/-0.254 | BP0381-0445-0889-BSHT |
| 38.100 (1.500") +0.025/+0.051 (mm) | 46.038 +0.025/+0.064 | 25.400 | BP0381-0460-0254-BSTL |
| 38.100 (1.500") +0.076/+0.102 (mm) | 46.038 +0.051/+0.089 | 25.400 +/-0.127 | BP0381-0460-0254-BSHT |
| 38.100 (1.500") +0.076/+0.102 (mm) | 46.038 +0.089/+0.127 | 25.400 +/-0.127 | BP0381-0460-0254-BSHH |
| 38.100 (1.500") +0.051/+0.076 (mm) | 46.038 +0.051/+0.089 | 38.100 +/-0.127 | BP0381-0460-0381-BSHT1 |
| 38.100 (1.500") +0.076/+0.102 (mm) | 46.038 +0.051/+0.089 | 38.100 +/-0.127 | BP0381-0460-0381-BSHT2 |
| 38.100 (1.500") +0.076/+0.102 (mm) | 46.038 +0.089/+0.127 | 38.100 +/-0.127 | BP0381-0460-0381-BSHH |
| 38.100 (1.500") +0.025/+0.051 (mm) | 46.038 +0.025/+0.064 | 41.275 | BP0381-0460-0413-BSTL |
| 38.100 (1.500") +0.076/+0.102 (mm) | 46.038 +0.051/+0.089 | 41.275 +/-0.190 | BP0381-0460-0413-BSHT |
| 38.100 (1.500") +0.076/+0.102 (mm) | 46.038 +0.089/+0.127 | 41.275 +/-0.190 | BP0381-0460-0413-BSHH |
| 38.100 (1.500") +0.076/+0.102 (mm) | 46.038 +0.051/+0.089 | 50.800 +/-0.190 | BP0381-0460-0508-BSHT |
| 38.100 (1.500") +0.051/+0.076 (mm) | 46.038 +0.051/+0.089 | 76.200 +/-0.190 | BP0381-0460-0762-BSHT1 |
| 38.100 (1.500") +0.076/+0.102 (mm) | 46.038 +0.051/+0.089 | 76.200 +/-0.190 | BP0381-0460-0762-BSHT2 |
| 38.100 (1.500") +0.076/+0.102 (mm) | 46.038 +0.089/+0.127 | 76.200 +/-0.190 | BP0381-0460-0762-BSHH |
| 38.100 (1.500") +0.051/+0.076 (mm) | 47.625 +0.038/+0.076 | 38.100 | BP0381-0476-0381-BSHT1 |
| 38.100 (1.500") +0.076/+0.102 (mm) | 47.625 +0.064/+0.102 | 38.100 +/-0.127 | BP0381-0476-0381-BSHT2 |
| 38.100 (1.500") +0.076/+0.102 (mm) | 47.625 +0.089/+0.127 | 38.100 +/-0.127 | BP0381-0476-0381-BSHH |
| 38.100 (1.500") +0.051/+0.076 (mm) | 47.625 +0.038/+0.076 | 44.450 +/-0.190 | BP0381-0476-0445-BSHT |
| 38.100 (1.500") +0.051/+0.076 (mm) | 47.625 +0.038/+0.076 | 50.800 | BP0381-0476-0508-BSHT1 |
| 38.100 (1.500") +0.076/+0.102 (mm) | 47.625 +0.064/+0.102 | 50.800 +/-0.190 | BP0381-0476-0508-BSHT2 |
| 38.100 (1.500") +0.076/+0.102 (mm) | 47.625 +0.089/+0.127 | 50.800 +/-0.190 | BP0381-0476-0508-BSHH |
| 38.100 (1.500") +0.051/+0.076 (mm) | 47.625 +0.038/+0.076 | 63.500 | BP0381-0476-0635-BSHT1 |
| 38.100 (1.500") +0.076/+0.102 (mm) | 47.625 +0.064/+0.102 | 63.500 +/-0.190 | BP0381-0476-0635-BSHT2 |
| 38.100 (1.500") +0.076/+0.102 (mm) | 47.625 +0.089/+0.127 | 63.500 +/-0.190 | BP0381-0476-0635-BSHH |
| 38.100 (1.500") +0.051/+0.076 (mm) | 47.625 +0.038/+0.076 | 69.850 | BP0381-0476-0699-BSHT1 |
| 38.100 (1.500") +0.076/+0.102 (mm) | 47.625 +0.064/+0.102 | 69.850 +/-0.190 | BP0381-0476-0699-BSHT2 |



Stocked or Short Delivery



Usually Available Short Delivery



Long delivery or not in current production

* Large Minimum Quantities

** Available only while stock lasts

Bushes - Plain

| Nominal ID (d) mm (inches) | Nominal OD (D) mm | Length (S) mm | Part Number |
|---------------------------------------|-------------------------|--------------------|-------------------------------|
| 38.100 (1.500") +0.076/+0.102 (mm) | 47.625 +0.089/+0.127 | 69.850 +/-0.190 | BP0381-0476-0699-BSHH |
| 38.100 (1.500") +0.051/+0.076 (mm) | 47.625 +0.038/+0.076 | 76.200 | BP0381-0476-0762-BSHT1 |
| 38.100 (1.500") +0.076/+0.102 (mm) | 47.625 +0.064/+0.102 | 76.200 +/-0.190 | BP0381-0476-0762-BSHT2 |
| 38.100 (1.500") +0.076/+0.102 (mm) | 47.625 +0.089/+0.127 | 76.200 +/-0.190 | BP0381-0476-0762-BSHH |
| 38.100 (1.500") +0.051/+0.076 (mm) | 50.800 +0.064/+0.102 | 25.400 | BP0381-0508-0254-BSHT1 |
| 38.100 (1.500") +0.076/+0.102 (mm) | 50.800 +0.064/+0.102 | 25.400 +/-0.127 | BP0381-0508-0254-BSHT2 |
| 38.100 (1.500") +0.076/+0.102 (mm) | 50.800 +0.089/+0.127 | 25.400 +/-0.127 | BP0381-0508-0254-BSHH |
| 38.100 (1.500") +0.051/+0.076 (mm) | 50.800 +0.064/+0.102 | 38.100 +/-0.127 | BP0381-0508-0381-BSHT1 |
| 38.100 (1.500") +0.076/+0.102 (mm) | 50.800 +0.064/+0.102 | 38.100 +/-0.127 | BP0381-0508-0381-BSHT2 |
| 38.100 (1.500") +0.076/+0.102 (mm) | 50.800 +0.089/+0.127 | 38.100 +/-0.127 | BP0381-0508-0381-BSHH |
| 38.100 (1.500") +0.051/+0.076 (mm) | 50.800 +0.064/+0.102 | 50.800 | BP0381-0508-0508-BSHT1 |
| 38.100 (1.500") +0.076/+0.102 (mm) | 50.800 +0.064/+0.102 | 50.800 +/-0.190 | BP0381-0508-0508-BSHT2 |
| 38.100 (1.500") +0.076/+0.102 (mm) | 50.800 +0.089/+0.127 | 50.800 +/-0.190 | BP0381-0508-0508-BSHH |
| 38.100 (1.500") +0.051/+0.076 (mm) | 50.800 +0.064/+0.102 | 63.500 | BP0381-0508-0635-BSHT1 |
| 38.100 (1.500") +0.076/+0.102 (mm) | 50.800 +0.064/+0.102 | 63.500 +/-0.190 | BP0381-0508-0635-BSHT2 |
| 38.100 (1.500") +0.076/+0.102 (mm) | 50.800 +0.089/+0.127 | 63.500 +/-0.190 | BP0381-0508-0635-BSHH |
| 38.100 (1.500") +0.076/+0.102 (mm) | 50.800 +0.064/+0.102 | 76.200 +/-0.190 | BP0381-0508-0762-BSHT |
| 38.100 (1.500") +0.076/+0.102 (mm) | 50.800 +0.089/+0.127 | 76.200 +/-0.190 | BP0381-0508-0762-BSHH |
| 38.100 (1.500") +0.051/+0.076 (mm) | 50.800 +0.064/+0.102 | 88.900 | BP0381-0508-0889-BSHT1 |
| 38.100 (1.500") +0.076/+0.102 (mm) | 50.800 +0.064/+0.102 | 88.900 +/-0.254 | BP0381-0508-0889-BSHT2 |
| 38.100 (1.500") +0.076/+0.102 (mm) | 50.800 +0.089/+0.127 | 88.900 +/-0.254 | BP0381-0508-0889-BSHH |
| 40.000 (1.575") +0.009/+0.040 (mm) | 46.000 +0.040/+0.070 | 25.000 +/-0.120 | BP0400-0460-0250-BSLT |
| 40.000 (1.575") +0.009/+0.040 (mm) | 46.000 +0.040/+0.070 | 30.000 +/-0.127 | BP0400-0460-0300-BSLT |
| 40.000 (1.575") +0.009/+0.040 (mm) | 46.000 +0.040/+0.070 | 32.000 +/-0.120 | BP0400-0460-0320-BSLT |
| 40.000 (1.575") +0.009/+0.040 (mm) | 46.000 +0.040/+0.070 | 40.000 +/-0.190 | BP0400-0460-0400-BSLT |
| 40.000 (1.575") +0.009/+0.040 (mm) | 46.000 +0.040/+0.070 | 50.000 +/-0.190 | BP0400-0460-0500-BSLT |
| 40.000 (1.575") +0.009/+0.040 (mm) | 50.000 +0.040/+0.070 | 25.000 +/-0.127 | BP0400-0500-0250-BSLT |
| 40.000 (1.575") +0.009/+0.040 (mm) | 50.000 +0.040/+0.070 | 30.000 +/-0.127 | BP0400-0500-0300-BSLT |
| 40.000 (1.575") +0.009/+0.040 (mm) | 50.000 +0.040/+0.070 | 32.000 +/-0.120 | BP0400-0500-0320-BSLT |
| 40.000 (1.575") +0.009/+0.040 (mm) | 50.000 +0.040/+0.070 | 35.000 +/-0.127 | BP0400-0500-0350-BSLT |
| 40.000 (1.575") +0.009/+0.040 (mm) | 50.000 +0.040/+0.070 | 40.000 +/-0.190 | BP0400-0500-0400-BSLT |
| 40.000 (1.575") +0.009/+0.040 (mm) | 50.000 +0.040/+0.070 | 50.000 +/-0.190 | BP0400-0500-0500-BSLT |
| 40.000 (1.575") +0.009/+0.040 (mm) | 50.000 +0.040/+0.070 | 60.000 +/-0.190 | BP0400-0500-0600-BSLT |
| 41.275 (1.625") +0.013/+0.051 (mm) | 47.625 +0.064/+0.102 | 25.400 +/-0.127 | BP0413-0476-0254-BSLT |



Stocked or Short Delivery



Usually Available Short Delivery



Long delivery or not in current production

* Large Minimum Quantities

** Available only while stock lasts

Bushes - Plain

| Nominal ID (d) mm (inches) | Nominal OD (D) mm | Length (S) mm | Part Number |
|---------------------------------------|-------------------------|--------------------|-------------------------------|
| 41.275 (1.625") +0.013/+0.051 (mm) | 47.625 +0.064/+0.102 | 31.750 | BP0413-0476-0318-BSLT |
| 41.275 (1.625") +0.038/+0.076 (mm) | 47.625 +0.038/+0.076 | 31.750 +/-0.127 | BP0413-0476-0318-BSTT1 |
| 41.275 (1.625") +0.064/+0.102 (mm) | 47.625 +0.064/+0.102 | 31.750 +/-0.127 | BP0413-0476-0318-BSTT2 |
| 41.275 (1.625") +0.064/+0.102 (mm) | 47.625 +0.089/+0.127 | 31.750 +/-0.127 | BP0413-0476-0318-BSTH |
| 41.275 (1.625") +0.013/+0.051 (mm) | 47.625 +0.064/+0.102 | 38.100 | BP0413-0476-0381-BSLT |
| 41.275 (1.625") +0.038/+0.076 (mm) | 47.625 +0.038/+0.076 | 38.100 +/-0.127 | BP0413-0476-0381-BSTT1 |
| 41.275 (1.625") +0.064/+0.102 (mm) | 47.625 +0.064/+0.102 | 38.100 +/-0.127 | BP0413-0476-0381-BSTT2 |
| 41.275 (1.625") +0.064/+0.102 (mm) | 47.625 +0.089/+0.127 | 38.100 +/-0.127 | BP0413-0476-0381-BSTH |
| 41.275 (1.625") +0.013/+0.051 (mm) | 47.625 +0.064/+0.102 | 44.450 | BP0413-0476-0445-BSLT |
| 41.275 (1.625") +0.064/+0.102 (mm) | 47.625 +0.064/+0.102 | 44.450 +/-0.190 | BP0413-0476-0445-BSTT |
| 41.275 (1.625") +0.064/+0.102 (mm) | 47.625 +0.089/+0.127 | 44.450 +/-0.190 | BP0413-0476-0445-BSTH |
| 41.275 (1.625") +0.013/+0.051 (mm) | 47.625 +0.064/+0.102 | 50.800 | BP0413-0476-0508-BSLT |
| 41.275 (1.625") +0.038/+0.076 (mm) | 47.625 +0.038/+0.076 | 50.800 +/-0.190 | BP0413-0476-0508-BSTT1 |
| 41.275 (1.625") +0.064/+0.102 (mm) | 47.625 +0.064/+0.102 | 50.800 +/-0.190 | BP0413-0476-0508-BSTT2 |
| 41.275 (1.625") +0.064/+0.102 (mm) | 47.625 +0.089/+0.127 | 50.800 +/-0.190 | BP0413-0476-0508-BSTH |
| 41.275 (1.625") +0.013/+0.051 (mm) | 47.625 +0.064/+0.102 | 57.150 | BP0413-0476-0572-BSLT |
| 41.275 (1.625") +0.064/+0.102 (mm) | 47.625 +0.064/+0.102 | 57.150 +/-0.190 | BP0413-0476-0572-BSTT |
| 41.275 (1.625") +0.064/+0.102 (mm) | 47.625 +0.089/+0.127 | 57.150 +/-0.190 | BP0413-0476-0572-BSTH |
| 41.275 (1.625") +0.038/+0.076 (mm) | 47.625 +0.038/+0.076 | 63.500 +/-0.190 | BP0413-0476-0635-BSTT1 |
| 41.275 (1.625") +0.064/+0.102 (mm) | 47.625 +0.064/+0.102 | 63.500 +/-0.190 | BP0413-0476-0635-BSTT2 |
| 41.275 (1.625") +0.064/+0.102 (mm) | 47.625 +0.089/+0.127 | 63.500 +/-0.190 | BP0413-0476-0635-BSTH |
| 41.275 (1.625") +0.013/+0.051 (mm) | 47.625 +0.064/+0.102 | 69.850 +/-0.190 | BP0413-0476-0699-BSLT |
| 41.275 (1.625") +0.038/+0.076 (mm) | 47.625 +0.038/+0.076 | 76.200 +/-0.190 | BP0413-0476-0762-BSTT1 |
| 41.275 (1.625") +0.064/+0.102 (mm) | 47.625 +0.064/+0.102 | 76.200 +/-0.190 | BP0413-0476-0762-BSTT2 |
| 41.275 (1.625") +0.064/+0.102 (mm) | 47.625 +0.089/+0.127 | 76.200 +/-0.190 | BP0413-0476-0762-BSTH |
| 41.275 (1.625") +0.038/+0.076 (mm) | 50.800 +0.064/+0.102 | 25.400 +/-0.127 | BP0413-0508-0254-BSTT1 |
| 41.275 (1.625") +0.064/+0.102 (mm) | 50.800 +0.064/+0.102 | 25.400 +/-0.127 | BP0413-0508-0254-BSTT2 |
| 41.275 (1.625") +0.064/+0.102 (mm) | 50.800 +0.089/+0.127 | 25.400 +/-0.127 | BP0413-0508-0254-BSTH |
| 41.275 (1.625") +0.000/+0.038 (mm) | 50.800 +0.064/+0.102 | 38.100 | BP0413-0508-0381-BSLT |
| 41.275 (1.625") +0.038/+0.076 (mm) | 50.800 +0.064/+0.102 | 38.100 +/-0.127 | BP0413-0508-0381-BSTT1 |
| 41.275 (1.625") +0.064/+0.102 (mm) | 50.800 +0.064/+0.102 | 38.100 +/-0.127 | BP0413-0508-0381-BSTT2 |
| 41.275 (1.625") +0.064/+0.102 (mm) | 50.800 +0.089/+0.127 | 38.100 +/-0.127 | BP0413-0508-0381-BSTH |
| 41.275 (1.625") +0.064/+0.102 (mm) | 50.800 +0.064/+0.102 | 44.450 +/-0.190 | BP0413-0508-0445-BSTT |
| 41.275 (1.625") +0.000/+0.038 (mm) | 50.800 +0.064/+0.102 | 50.800 | BP0413-0508-0508-BSLT |

Stocked or Short Delivery
 Usually Available Short Delivery
 Long delivery or not in current production

* Large Minimum Quantities

** Available only while stock lasts

Bushes - Plain

| Nominal ID (d) mm (inches) | Nominal OD (D) mm | Length (S) mm | Part Number |
|---------------------------------------|-------------------------|---------------------|-------------------------------|
| 41.275 (1.625") +0.038/+0.076 (mm) | 50.800 +0.064/+0.102 | 50.800 +/-0.190 | BP0413-0508-0508-BSTT1 |
| 41.275 (1.625") +0.064/+0.102 (mm) | 50.800 +0.064/+0.102 | 50.800 +/-0.190 | BP0413-0508-0508-BSTT2 |
| 41.275 (1.625") +0.064/+0.102 (mm) | 50.800 +0.089/+0.127 | 50.800 +/-0.190 | BP0413-0508-0508-BSTH |
| 41.275 (1.625") +0.000/+0.038 (mm) | 50.800 +0.064/+0.102 | 63.500 | BP0413-0508-0635-BSLT |
| 41.275 (1.625") +0.064/+0.102 (mm) | 50.800 +0.064/+0.102 | 63.500 +/-0.190 | BP0413-0508-0635-BSTT |
| 41.275 (1.625") +0.064/+0.102 (mm) | 50.800 +0.089/+0.127 | 63.500 +/-0.190 | BP0413-0508-0635-BSTH |
| 41.275 (1.625") +0.000/+0.038 (mm) | 50.800 +0.064/+0.102 | 76.200 | BP0413-0508-0762-BSLT |
| 41.275 (1.625") +0.038/+0.076 (mm) | 50.800 +0.064/+0.102 | 76.200 +/-0.190 | BP0413-0508-0762-BSTT1 |
| 41.275 (1.625") +0.064/+0.102 (mm) | 50.800 +0.064/+0.102 | 76.200 +/-0.190 | BP0413-0508-0762-BSTT2 |
| 41.275 (1.625") +0.064/+0.102 (mm) | 50.800 +0.089/+0.127 | 76.200 +/-0.190 | BP0413-0508-0762-BSTH |
| 42.863 (1.688") +0.038/+0.076 (mm) | 55.563 +0.051/+0.089 | 44.450 +/-0.190 | BP0429-0556-0445-BSTT |
| 42.863 (1.688") +0.064/+0.102 (mm) | 55.563 +0.089/+0.127 | 44.450 +/-0.190 | BP0429-0556-0445-BSTH |
| 42.863 (1.688") +0.038/+0.076 (mm) | 55.563 +0.051/+0.089 | 50.800 +/-0.190 | BP0429-0556-0508-BSTT1 |
| 42.863 (1.688") +0.038/+0.076 (mm) | 55.563 +0.064/+0.102 | 50.800 | BP0429-0556-0508-BSTT2 |
| 42.863 (1.688") +0.064/+0.102 (mm) | 55.563 +0.089/+0.127 | 50.800 +/-0.190 | BP0429-0556-0508-BSTH |
| 42.863 (1.688") +0.038/+0.076 (mm) | 55.563 +0.051/+0.089 | 76.200 +/-0.190 | BP0429-0556-0762-BSTT |
| 42.863 (1.688") +0.064/+0.102 (mm) | 55.563 +0.089/+0.127 | 76.200 +/-0.190 | BP0429-0556-0762-BSTH |
| 42.863 (1.688") +0.038/+0.076 (mm) | 55.563 +0.051/+0.089 | 101.600 +/-0.254 | BP0429-0556-1016-BSTT1 |
| 42.863 (1.688") +0.038/+0.076 (mm) | 55.563 +0.064/+0.102 | 101.600 | BP0429-0556-1016-BSTT2 |
| 42.863 (1.688") +0.064/+0.102 (mm) | 55.563 +0.089/+0.127 | 101.600 +/-0.254 | BP0429-0556-1016-BSTH |
| 44.450 (1.750") +0.025/+0.064 (mm) | 49.213 +0.064/+0.102 | 31.750 +/-0.127 | BP0445-0492-0318-BSLT |
| 44.450 (1.750") +0.025/+0.064 (mm) | 49.213 +0.064/+0.102 | 38.100 +/-0.127 | BP0445-0492-0381-BSLT |
| 44.450 (1.750") +0.038/+0.076 (mm) | 50.800 +0.064/+0.102 | 25.400 | BP0445-0508-0254-BSTT1 |
| 44.450 (1.750") +0.064/+0.102 (mm) | 50.800 +0.064/+0.102 | 25.400 +/-0.127 | BP0445-0508-0254-BSTT2 |
| 44.450 (1.750") +0.064/+0.102 (mm) | 50.800 +0.089/+0.127 | 25.400 +/-0.127 | BP0445-0508-0254-BSTH |
| 44.450 (1.750") +0.064/+0.102 (mm) | 50.800 +0.064/+0.102 | 31.750 +/-0.127 | BP0445-0508-0318-BSTT |
| 44.450 (1.750") +0.064/+0.102 (mm) | 50.800 +0.089/+0.127 | 31.750 +/-0.127 | BP0445-0508-0318-BSTH |
| 44.450 (1.750") +0.038/+0.076 (mm) | 50.800 +0.064/+0.102 | 38.100 | BP0445-0508-0381-BSTT1 |
| 44.450 (1.750") +0.064/+0.102 (mm) | 50.800 +0.064/+0.102 | 38.100 +/-0.127 | BP0445-0508-0381-BSTT2 |
| 44.450 (1.750") +0.064/+0.102 (mm) | 50.800 +0.089/+0.127 | 38.100 +/-0.127 | BP0445-0508-0381-BSTH |
| 44.450 (1.750") +0.064/+0.102 (mm) | 50.800 +0.064/+0.102 | 44.450 +/-0.190 | BP0445-0508-0445-BSTT |
| 44.450 (1.750") +0.064/+0.102 (mm) | 50.800 +0.089/+0.127 | 44.450 +/-0.190 | BP0445-0508-0445-BSTH |
| 44.450 (1.750") +0.038/+0.076 (mm) | 50.800 +0.064/+0.102 | 47.625 +/-0.190 | BP0445-0508-0476-BSTT |
| 44.450 (1.750") +0.038/+0.076 (mm) | 50.800 +0.064/+0.102 | 50.800 | BP0445-0508-0508-BSTT1 |



Stocked or Short Delivery



Usually Available Short Delivery



Long delivery or not in current production

* Large Minimum Quantities

** Available only while stock lasts

Bushes - Plain

| Nominal ID (d) mm (inches) | Nominal OD (D) mm | Length (S) mm | Part Number |
|---------------------------------------|-------------------------|--------------------|-------------------------------|
| 44.450 (1.750") +0.064/+0.102 (mm) | 50.800 +0.064/+0.102 | 50.800 +/-0.190 | BP0445-0508-0508-BSTT2 |
| 44.450 (1.750") +0.064/+0.102 (mm) | 50.800 +0.089/+0.127 | 50.800 +/-0.190 | BP0445-0508-0508-BSTH |
| 44.450 (1.750") +0.038/+0.076 (mm) | 50.800 +0.064/+0.102 | 63.500 | BP0445-0508-0635-BSTT1 |
| 44.450 (1.750") +0.064/+0.102 (mm) | 50.800 +0.064/+0.102 | 63.500 +/-0.190 | BP0445-0508-0635-BSTT2 |
| 44.450 (1.750") +0.064/+0.102 (mm) | 50.800 +0.089/+0.127 | 63.500 +/-0.190 | BP0445-0508-0635-BSTH |
| 44.450 (1.750") +0.038/+0.076 (mm) | 50.800 +0.064/+0.102 | 69.850 +/-0.190 | BP0445-0508-0699-BSTT |
| 44.450 (1.750") +0.038/+0.076 (mm) | 50.800 +0.064/+0.102 | 76.200 | BP0445-0508-0762-BSTT1 |
| 44.450 (1.750") +0.064/+0.102 (mm) | 50.800 +0.064/+0.102 | 76.200 +/-0.190 | BP0445-0508-0762-BSTT2 |
| 44.450 (1.750") +0.064/+0.102 (mm) | 50.800 +0.089/+0.127 | 76.200 +/-0.190 | BP0445-0508-0762-BSTH |
| 44.450 (1.750") +0.064/+0.102 (mm) | 53.975 +0.038/+0.076 | 12.700 +/-0.127 | BP0445-0540-0127-BSTT |
| 44.450 (1.750") +0.064/+0.102 (mm) | 53.975 +0.064/+0.102 | 34.925 +/-0.127 | BP0445-0540-0349-BSTT |
| 44.450 (1.750") +0.038/+0.076 (mm) | 53.975 +0.064/+0.102 | 38.100 +/-0.127 | BP0445-0540-0381-BSTT1 |
| 44.450 (1.750") +0.064/+0.102 (mm) | 53.975 +0.038/+0.076 | 38.100 +/-0.127 | BP0445-0540-0381-BSTT2 |
| 44.450 (1.750") +0.064/+0.102 (mm) | 53.975 +0.064/+0.102 | 38.100 +/-0.127 | BP0445-0540-0381-BSTT3 |
| 44.450 (1.750") +0.064/+0.102 (mm) | 53.975 +0.089/+0.127 | 38.100 +/-0.127 | BP0445-0540-0381-BSTH |
| 44.450 (1.750") +0.038/+0.076 (mm) | 53.975 +0.064/+0.102 | 50.800 +/-0.190 | BP0445-0540-0508-BSTT1 |
| 44.450 (1.750") +0.064/+0.102 (mm) | 53.975 +0.038/+0.076 | 50.800 +/-0.190 | BP0445-0540-0508-BSTT2 |
| 44.450 (1.750") +0.064/+0.102 (mm) | 53.975 +0.064/+0.102 | 50.800 +/-0.190 | BP0445-0540-0508-BSTT3 |
| 44.450 (1.750") +0.064/+0.102 (mm) | 53.975 +0.089/+0.127 | 50.800 +/-0.190 | BP0445-0540-0508-BSTH |
| 44.450 (1.750") +0.064/+0.102 (mm) | 53.975 +0.038/+0.076 | 63.500 +/-0.190 | BP0445-0540-0635-BSTT |
| 44.450 (1.750") +0.038/+0.076 (mm) | 53.975 +0.064/+0.102 | 76.200 +/-0.190 | BP0445-0540-0762-BSTT1 |
| 44.450 (1.750") +0.064/+0.102 (mm) | 53.975 +0.064/+0.102 | 76.200 +/-0.190 | BP0445-0540-0762-BSTT2 |
| 44.450 (1.750") +0.064/+0.102 (mm) | 53.975 +0.089/+0.127 | 76.200 +/-0.190 | BP0445-0540-0762-BSTH |
| 44.450 (1.750") +0.038/+0.076 (mm) | 57.150 +0.038/+0.076 | 50.800 +/-0.190 | BP0445-0572-0508-BSTT |
| 44.450 (1.750") +0.038/+0.076 (mm) | 57.150 +0.038/+0.076 | 63.500 +/-0.190 | BP0445-0572-0635-BSTT |
| 44.450 (1.750") +0.038/+0.076 (mm) | 57.150 +0.038/+0.076 | 76.200 +/-0.190 | BP0445-0572-0762-BSTT |
| 45.000 (1.772") +0.009/+0.040 (mm) | 51.000 +0.050/+0.083 | 28.000 +/-0.120 | BP0450-0510-0280-BSLT |
| 45.000 (1.772") +0.009/+0.040 (mm) | 51.000 +0.050/+0.083 | 35.000 +/-0.127 | BP0450-0510-0350-BSLT |
| 45.000 (1.772") +0.009/+0.040 (mm) | 51.000 +0.050/+0.083 | 36.000 +/-0.120 | BP0450-0510-0360-BSLT |
| 45.000 (1.772") +0.009/+0.040 (mm) | 51.000 +0.050/+0.083 | 45.000 +/-0.190 | BP0450-0510-0450-BSLT |
| 45.000 (1.772") +0.009/+0.040 (mm) | 51.000 +0.050/+0.083 | 55.000 +/-0.190 | BP0450-0510-0550-BSLT |
| 45.000 (1.772") +0.009/+0.040 (mm) | 51.000 +0.050/+0.083 | 56.000 +/-0.250 | BP0450-0510-0560-BSLT |
| 47.625 (1.875") +0.038/+0.076 (mm) | 57.150 +0.064/+0.102 | 19.050 +/-0.127 | BP0476-0572-0191-BSTT |
| 47.625 (1.875") +0.038/+0.076 (mm) | 57.150 +0.064/+0.102 | 50.800 +/-0.190 | BP0476-0572-0508-BSTT |



Stocked or Short Delivery



Usually Available Short Delivery



Long delivery or not in current production

* Large Minimum Quantities

** Available only while stock lasts

Bushes - Plain

| Nominal ID (d) mm (inches) | Nominal OD (D) mm | Length (S) mm | Part Number |
|---------------------------------------|-------------------------|---------------------|-------------------------------|
| 47.625 (1.875") +0.038/+0.076 (mm) | 57.150 +0.064/+0.102 | 63.500 +/-0.190 | BP0476-0572-0635-BSTT |
| 47.625 (1.875") +0.038/+0.076 (mm) | 57.150 +0.064/+0.102 | 76.200 +/-0.190 | BP0476-0572-0762-BSTT |
| 49.213 (1.938") +0.025/+0.064 (mm) | 53.975 +0.051/+0.089 | 50.800 +/-0.190 | BP0492-0540-0508-BSLT |
| 49.213 (1.938") +0.025/+0.064 (mm) | 53.975 +0.051/+0.089 | 63.500 | BP0492-0540-0635-BSLT |
| 49.213 (1.938") +0.038/+0.076 (mm) | 58.738 +0.051/+0.089 | 50.800 +/-0.190 | BP0492-0587-0508-BSTT1 |
| 49.213 (1.938") +0.038/+0.076 (mm) | 58.738 +0.064/+0.102 | 50.800 +/-0.190 | BP0492-0587-0508-BSTT2 |
| 49.213 (1.938") +0.064/+0.102 (mm) | 58.738 +0.089/+0.127 | 50.800 +/-0.190 | BP0492-0587-0508-BSTH |
| 49.213 (1.938") +0.038/+0.076 (mm) | 58.738 +0.064/+0.102 | 63.500 +/-0.190 | BP0492-0587-0635-BSTT |
| 49.213 (1.938") +0.064/+0.102 (mm) | 58.738 +0.089/+0.127 | 63.500 +/-0.190 | BP0492-0587-0635-BSTH |
| 49.213 (1.938") +0.038/+0.076 (mm) | 58.738 +0.051/+0.089 | 76.200 +/-0.190 | BP0492-0587-0762-BSTT1 |
| 49.213 (1.938") +0.038/+0.076 (mm) | 58.738 +0.064/+0.102 | 76.200 +/-0.190 | BP0492-0587-0762-BSTT2 |
| 49.213 (1.938") +0.064/+0.102 (mm) | 58.738 +0.089/+0.127 | 76.200 +/-0.190 | BP0492-0587-0762-BSTH |
| 49.213 (1.938") +0.038/+0.076 (mm) | 58.738 +0.051/+0.089 | 101.600 +/-0.254 | BP0492-0587-1016-BSTT1 |
| 49.213 (1.938") +0.038/+0.076 (mm) | 58.738 +0.064/+0.102 | 101.600 +/-0.254 | BP0492-0587-1016-BSTT2 |
| 49.213 (1.938") +0.064/+0.102 (mm) | 58.738 +0.089/+0.127 | 101.600 +/-0.254 | BP0492-0587-1016-BSTH |
| 49.213 (1.938") +0.076/+0.114 (mm) | 61.913 +0.064/+0.102 | 38.100 +/-0.127 | BP0492-0619-0381-BSHT |
| 49.213 (1.938") +0.076/+0.114 (mm) | 61.913 +0.064/+0.102 | 50.800 +/-0.190 | BP0492-0619-0508-BSHT |
| 50.000 (1.969") +0.003/+0.041 (mm) | 60.000 +0.033/+0.071 | 40.000 +/-0.190 | BP0500-0600-0400-BSLL |
| 50.800 (2.000") +0.038/+0.076 (mm) | 57.150 +0.064/+0.102 | 19.050 +/-0.127 | BP0508-0572-0191-BSTT |
| 50.800 (2.000") +0.064/+0.102 (mm) | 57.150 +0.089/+0.127 | 19.050 +/-0.127 | BP0508-0572-0191-BSTH |
| 50.800 (2.000") +0.038/+0.076 (mm) | 57.150 +0.064/+0.102 | 25.400 +/-0.127 | BP0508-0572-0254-BSTT1 |
| 50.800 (2.000") +0.064/+0.102 (mm) | 57.150 +0.064/+0.102 | 25.400 +/-0.127 | BP0508-0572-0254-BSTT2 |
| 50.800 (2.000") +0.064/+0.102 (mm) | 57.150 +0.089/+0.127 | 25.400 | BP0508-0572-0254-BSTH |
| 50.800 (2.000") +0.038/+0.076 (mm) | 57.150 +0.064/+0.102 | 38.100 | BP0508-0572-0381-BSTT1 |
| 50.800 (2.000") +0.064/+0.102 (mm) | 57.150 +0.064/+0.102 | 38.100 +/-0.127 | BP0508-0572-0381-BSTT2 |
| 50.800 (2.000") +0.064/+0.102 (mm) | 57.150 +0.089/+0.127 | 38.100 +/-0.127 | BP0508-0572-0381-BSTH |
| 50.800 (2.000") +0.038/+0.076 (mm) | 57.150 +0.064/+0.102 | 50.800 | BP0508-0572-0508-BSTT1 |
| 50.800 (2.000") +0.064/+0.102 (mm) | 57.150 +0.064/+0.102 | 50.800 +/-0.190 | BP0508-0572-0508-BSTT2 |
| 50.800 (2.000") +0.064/+0.102 (mm) | 57.150 +0.089/+0.127 | 50.800 +/-0.190 | BP0508-0572-0508-BSTH |
| 50.800 (2.000") +0.038/+0.076 (mm) | 57.150 +0.064/+0.102 | 63.500 | BP0508-0572-0635-BSTT1 |
| 50.800 (2.000") +0.064/+0.102 (mm) | 57.150 +0.064/+0.102 | 63.500 +/-0.190 | BP0508-0572-0635-BSTT2 |
| 50.800 (2.000") +0.064/+0.102 (mm) | 57.150 +0.089/+0.127 | 63.500 +/-0.190 | BP0508-0572-0635-BSTH |
| 50.800 (2.000") +0.038/+0.076 (mm) | 57.150 +0.064/+0.102 | 76.200 | BP0508-0572-0762-BSTT1 |
| 50.800 (2.000") +0.064/+0.102 (mm) | 57.150 +0.064/+0.102 | 76.200 +/-0.190 | BP0508-0572-0762-BSTT2 |

Stocked or Short Delivery
 Usually Available Short Delivery
 Long delivery or not in current production

* Large Minimum Quantities

** Available only while stock lasts

Bushes - Plain

| Nominal ID (d) mm (inches) | Nominal OD (D) mm | Length (S) mm | Part Number |
|---------------------------------------|-------------------------|---------------------|------------------------------|
| 50.800 (2.000") +0.064/+0.102 (mm) | 57.150 +0.089/+0.127 | 76.200 +/-0.190 | BP0508-0572-0762-BSTH |
| 50.800 (2.000") +0.038/+0.076 (mm) | 60.325 +0.064/+0.102 | 28.575 +/-0.127 | BP0508-0603-0286-BSTT |
| 50.800 (2.000") +0.064/+0.102 (mm) | 60.325 +0.089/+0.127 | 28.575 +/-0.127 | BP0508-0603-0286-BSTH |
| 50.800 (2.000") +0.038/+0.076 (mm) | 60.325 +0.064/+0.102 | 38.100 | BP0508-0603-0381-BSTT |
| 50.800 (2.000") +0.064/+0.102 (mm) | 60.325 +0.089/+0.127 | 38.100 +/-0.127 | BP0508-0603-0381-BSTH |
| 50.800 (2.000") +0.038/+0.076 (mm) | 60.325 +0.064/+0.102 | 44.450 | BP0508-0603-0445-BSTT |
| 50.800 (2.000") +0.064/+0.102 (mm) | 60.325 +0.089/+0.127 | 44.450 +/-0.190 | BP0508-0603-0445-BSTH |
| 50.800 (2.000") +0.038/+0.076 (mm) | 60.325 +0.064/+0.102 | 50.800 | BP0508-0603-0508-BSTT |
| 50.800 (2.000") +0.064/+0.102 (mm) | 60.325 +0.089/+0.127 | 50.800 +/-0.190 | BP0508-0603-0508-BSTH |
| 50.800 (2.000") +0.038/+0.076 (mm) | 60.325 +0.064/+0.102 | 63.500 | BP0508-0603-0635-BSTT |
| 50.800 (2.000") +0.064/+0.102 (mm) | 60.325 +0.089/+0.127 | 63.500 +/-0.190 | BP0508-0603-0635-BSTH |
| 50.800 (2.000") +0.038/+0.076 (mm) | 60.325 +0.064/+0.102 | 69.850 +/-0.190 | BP0508-0603-0699-BSTT |
| 50.800 (2.000") +0.064/+0.102 (mm) | 60.325 +0.089/+0.127 | 69.850 +/-0.190 | BP0508-0603-0699-BSTH |
| 50.800 (2.000") +0.038/+0.076 (mm) | 60.325 +0.064/+0.102 | 76.200 | BP0508-0603-0762-BSTT |
| 50.800 (2.000") +0.064/+0.102 (mm) | 60.325 +0.089/+0.127 | 76.200 +/-0.190 | BP0508-0603-0762-BSTH |
| 50.800 (2.000") +0.038/+0.076 (mm) | 60.325 +0.064/+0.102 | 88.900 | BP0508-0603-0889-BSTT |
| 50.800 (2.000") +0.064/+0.102 (mm) | 60.325 +0.089/+0.127 | 88.900 +/-0.254 | BP0508-0603-0889-BSTH |
| 50.800 (2.000") +0.038/+0.076 (mm) | 60.325 +0.064/+0.102 | 101.600 | BP0508-0603-1016-BSTT |
| 50.800 (2.000") +0.064/+0.102 (mm) | 60.325 +0.089/+0.127 | 101.600 +/-0.254 | BP0508-0603-1016-BSTH |
| 50.800 (2.000") +0.064/+0.102 (mm) | 63.500 +0.064/+0.102 | 25.400 +/-0.127 | BP0508-0635-0254-BSTT |
| 50.800 (2.000") +0.064/+0.102 (mm) | 63.500 +0.089/+0.127 | 25.400 +/-0.127 | BP0508-0635-0254-BSTH |
| 50.800 (2.000") +0.038/+0.076 (mm) | 63.500 +0.038/+0.076 | 38.100 | BP0508-0635-0381-BSTT |
| 50.800 (2.000") +0.064/+0.102 (mm) | 63.500 +0.089/+0.127 | 38.100 +/-0.127 | BP0508-0635-0381-BSTH |
| 50.800 (2.000") +0.038/+0.076 (mm) | 63.500 +0.038/+0.076 | 50.800 | BP0508-0635-0508-BSTT1 |
| 50.800 (2.000") +0.064/+0.102 (mm) | 63.500 +0.064/+0.102 | 50.800 +/-0.190 | BP0508-0635-0508-BSTT2 |
| 50.800 (2.000") +0.064/+0.102 (mm) | 63.500 +0.089/+0.127 | 50.800 +/-0.190 | BP0508-0635-0508-BSTH |
| 50.800 (2.000") +0.038/+0.076 (mm) | 63.500 +0.038/+0.076 | 63.500 | BP0508-0635-0635-BSTT |
| 50.800 (2.000") +0.064/+0.102 (mm) | 63.500 +0.089/+0.127 | 63.500 +/-0.190 | BP0508-0635-0635-BSTH |
| 50.800 (2.000") +0.038/+0.076 (mm) | 63.500 +0.038/+0.076 | 76.200 | BP0508-0635-0762-BSTT1 |
| 50.800 (2.000") +0.064/+0.102 (mm) | 63.500 +0.064/+0.102 | 76.200 +/-0.190 | BP0508-0635-0762-BSTT2 |
| 50.800 (2.000") +0.064/+0.102 (mm) | 63.500 +0.089/+0.127 | 76.200 +/-0.190 | BP0508-0635-0762-BSTH |
| 50.800 (2.000") +0.064/+0.102 (mm) | 63.500 +0.089/+0.127 | 88.900 +/-0.254 | BP0508-0635-0889-BSTH |
| 50.800 (2.000") +0.064/+0.102 (mm) | 63.500 +0.089/+0.127 | 101.600 +/-0.254 | BP0508-0635-1016-BSTH |
| 55.563 (2.188") +0.025/+0.064 (mm) | 60.325 +0.064/+0.102 | 38.100 +/-0.127 | BP0556-0603-0381-BSLT |

Stocked or Short Delivery
 Usually Available Short Delivery
 Long delivery or not in current production

* Large Minimum Quantities

** Available only while stock lasts

Bushes - Plain

| Nominal ID (d) mm (inches) | Nominal OD (D) mm | Length (S) mm | Part Number |
|---------------------------------------|-------------------------|---------------------|-------------------------------|
| 57.150 (2.250") +0.064/+0.102 (mm) | 66.675 +0.064/+0.114 | 50.800 +/-0.190 | BP0572-0667-0508-BSTT1 |
| 57.150 (2.250") +0.064/+0.102 (mm) | 66.675 +0.076/+0.127 | 50.800 +/-0.190 | BP0572-0667-0508-BSTT2 |
| 57.150 (2.250") +0.064/+0.102 (mm) | 66.675 +0.102/+0.152 | 50.800 +/-0.190 | BP0572-0667-0508-BSTH |
| 57.150 (2.250") +0.064/+0.102 (mm) | 66.675 +0.076/+0.127 | 63.500 +/-0.190 | BP0572-0667-0635-BSTT |
| 57.150 (2.250") +0.064/+0.102 (mm) | 66.675 +0.102/+0.152 | 63.500 +/-0.190 | BP0572-0667-0635-BSTH |
| 57.150 (2.250") +0.064/+0.102 (mm) | 66.675 +0.064/+0.114 | 76.200 +/-0.190 | BP0572-0667-0762-BSTT1 |
| 57.150 (2.250") +0.064/+0.102 (mm) | 66.675 +0.076/+0.127 | 76.200 +/-0.190 | BP0572-0667-0762-BSTT2 |
| 57.150 (2.250") +0.064/+0.102 (mm) | 66.675 +0.102/+0.152 | 76.200 +/-0.190 | BP0572-0667-0762-BSTH |
| 57.150 (2.250") +0.064/+0.102 (mm) | 66.675 +0.064/+0.114 | 88.900 +/-0.254 | BP0572-0667-0889-BSTT |
| 57.150 (2.250") +0.064/+0.102 (mm) | 66.675 +0.064/+0.114 | 114.300 +/-0.254 | BP0572-0667-1143-BSTT |
| 57.150 (2.250") +0.038/+0.076 (mm) | 69.850 +0.025/+0.076 | 38.100 +/-0.127 | BP0572-0699-0381-BSTL |
| 57.150 (2.250") +0.038/+0.076 (mm) | 69.850 +0.025/+0.076 | 50.800 +/-0.190 | BP0572-0699-0508-BSTL |
| 57.150 (2.250") +0.064/+0.102 (mm) | 69.850 +0.051/+0.102 | 50.800 +/-0.190 | BP0572-0699-0508-BSTT1 |
| 57.150 (2.250") +0.064/+0.102 (mm) | 69.850 +0.076/+0.127 | 50.800 +/-0.190 | BP0572-0699-0508-BSTT2 |
| 57.150 (2.250") +0.064/+0.102 (mm) | 69.850 +0.102/+0.152 | 50.800 +/-0.190 | BP0572-0699-0508-BSTH |
| 57.150 (2.250") +0.038/+0.076 (mm) | 69.850 +0.025/+0.076 | 76.200 +/-0.190 | BP0572-0699-0762-BSTL |
| 57.150 (2.250") +0.064/+0.102 (mm) | 69.850 +0.051/+0.102 | 76.200 +/-0.190 | BP0572-0699-0762-BSTT1 |
| 57.150 (2.250") +0.064/+0.102 (mm) | 69.850 +0.076/+0.127 | 76.200 +/-0.190 | BP0572-0699-0762-BSTT2 |
| 57.150 (2.250") +0.064/+0.102 (mm) | 69.850 +0.102/+0.152 | 76.200 +/-0.190 | BP0572-0699-0762-BSTH |
| 60.325 (2.375") +0.013/+0.051 (mm) | 66.675 +0.064/+0.114 | 31.750 +/-0.127 | BP0603-0667-0318-BSLT |
| 60.325 (2.375") +0.013/+0.051 (mm) | 66.675 +0.064/+0.114 | 41.275 +/-0.190 | BP0603-0667-0413-BSLT |
| 60.325 (2.375") +0.064/+0.102 (mm) | 69.850 +0.025/+0.076 | 50.800 | BP0603-0699-0508-BSTL |
| 60.325 (2.375") +0.064/+0.102 (mm) | 69.850 +0.051/+0.102 | 50.800 +/-0.190 | BP0603-0699-0508-BSTT1 |
| 60.325 (2.375") +0.064/+0.102 (mm) | 69.850 +0.076/+0.127 | 50.800 +/-0.190 | BP0603-0699-0508-BSTT2 |
| 60.325 (2.375") +0.064/+0.102 (mm) | 69.850 +0.102/+0.152 | 50.800 +/-0.190 | BP0603-0699-0508-BSTH |
| 60.325 (2.375") +0.064/+0.102 (mm) | 69.850 +0.025/+0.076 | 63.500 | BP0603-0699-0635-BSTL |
| 60.325 (2.375") +0.064/+0.102 (mm) | 69.850 +0.076/+0.127 | 63.500 +/-0.190 | BP0603-0699-0635-BSTT |
| 60.325 (2.375") +0.064/+0.102 (mm) | 69.850 +0.102/+0.152 | 63.500 +/-0.190 | BP0603-0699-0635-BSTH |
| 60.325 (2.375") +0.064/+0.102 (mm) | 69.850 +0.025/+0.076 | 76.200 | BP0603-0699-0762-BSTL |
| 60.325 (2.375") +0.064/+0.102 (mm) | 69.850 +0.051/+0.102 | 76.200 +/-0.190 | BP0603-0699-0762-BSTT1 |
| 60.325 (2.375") +0.064/+0.102 (mm) | 69.850 +0.076/+0.127 | 76.200 +/-0.190 | BP0603-0699-0762-BSTT2 |
| 60.325 (2.375") +0.064/+0.102 (mm) | 69.850 +0.102/+0.152 | 76.200 +/-0.190 | BP0603-0699-0762-BSTH |
| 63.500 (2.500") +0.089/+0.127 (mm) | 68.580 +0.102/+0.152 | 50.800 +/-0.190 | BP0635-0686-0508-BSHH |
| 63.500 (2.500") +0.089/+0.127 (mm) | 68.580 +0.102/+0.152 | 76.200 +/-0.190 | BP0635-0686-0762-BSHH |



Stocked or Short Delivery



Usually Available Short Delivery



Long delivery or not in current production

* Large Minimum Quantities

** Available only while stock lasts

Bushes - Plain

| Nominal ID (d) mm (inches) | Nominal OD (D) mm | Length (S) mm | Part Number |
|---------------------------------------|-------------------------|---------------------|-------------------------------|
| 63.500 (2.500") +0.089/+0.127 (mm) | 68.580 +0.102/+0.152 | 101.600 +/-0.254 | BP0635-0686-1016-BSHH |
| 63.500 (2.500") +0.064/+0.102 (mm) | 69.850 +0.051/+0.102 | 50.800 +/-0.190 | BP0635-0699-0508-BSTT |
| 63.500 (2.500") +0.089/+0.127 (mm) | 69.850 +0.051/+0.102 | 50.800 | BP0635-0699-0508-BSHT |
| 63.500 (2.500") +0.064/+0.102 (mm) | 69.850 +0.051/+0.102 | 63.500 +/-0.190 | BP0635-0699-0635-BSTT |
| 63.500 (2.500") +0.089/+0.127 (mm) | 69.850 +0.051/+0.102 | 63.500 | BP0635-0699-0635-BSHT |
| 63.500 (2.500") +0.064/+0.102 (mm) | 69.850 +0.051/+0.102 | 76.200 +/-0.190 | BP0635-0699-0762-BSTT |
| 63.500 (2.500") +0.089/+0.127 (mm) | 69.850 +0.051/+0.102 | 76.200 | BP0635-0699-0762-BSHT |
| 63.500 (2.500") +0.064/+0.102 (mm) | 69.850 +0.051/+0.102 | 101.600 +/-0.254 | BP0635-0699-1016-BSTT |
| 63.500 (2.500") +0.064/+0.102 (mm) | 73.025 +0.076/+0.127 | 57.150 +/-0.190 | BP0635-0730-0572-BSTT |
| 63.500 (2.500") +0.089/+0.127 (mm) | 73.025 +0.102/+0.152 | 57.150 +/-0.190 | BP0635-0730-0572-BSHH |
| 63.500 (2.500") +0.064/+0.102 (mm) | 73.025 +0.076/+0.127 | 63.500 +/-0.190 | BP0635-0730-0635-BSTT |
| 63.500 (2.500") +0.089/+0.127 (mm) | 73.025 +0.102/+0.152 | 63.500 +/-0.190 | BP0635-0730-0635-BSHH |
| 63.500 (2.500") +0.064/+0.102 (mm) | 73.025 +0.076/+0.127 | 76.200 +/-0.190 | BP0635-0730-0762-BSTT |
| 63.500 (2.500") +0.089/+0.127 (mm) | 73.025 +0.102/+0.152 | 76.200 +/-0.190 | BP0635-0730-0762-BSHH |
| 63.500 (2.500") +0.064/+0.102 (mm) | 76.200 +0.076/+0.127 | 50.800 +/-0.190 | BP0635-0762-0508-BSTT |
| 63.500 (2.500") +0.089/+0.127 (mm) | 76.200 +0.102/+0.152 | 50.800 +/-0.190 | BP0635-0762-0508-BSHH |
| 63.500 (2.500") +0.064/+0.102 (mm) | 76.200 +0.076/+0.127 | 63.500 +/-0.190 | BP0635-0762-0635-BSTT |
| 63.500 (2.500") +0.064/+0.102 (mm) | 76.200 +0.076/+0.127 | 76.200 +/-0.190 | BP0635-0762-0762-BSTT |
| 63.500 (2.500") +0.089/+0.127 (mm) | 76.200 +0.102/+0.152 | 76.200 +/-0.190 | BP0635-0762-0762-BSHH |
| 63.500 (2.500") +0.064/+0.102 (mm) | 76.200 +0.076/+0.127 | 101.600 +/-0.254 | BP0635-0762-1016-BSTT |
| 63.500 (2.500") +0.089/+0.127 (mm) | 76.200 +0.102/+0.152 | 101.600 +/-0.254 | BP0635-0762-1016-BSHH |
| 69.850 (2.750") +0.025/+0.076 (mm) | 76.200 +0.076/+0.127 | 38.100 +/-0.127 | BP0699-0762-0381-BSLT |
| 69.850 (2.750") +0.051/+0.102 (mm) | 76.200 +0.076/+0.127 | 38.100 +/-0.127 | BP0699-0762-0381-BSTT |
| 69.850 (2.750") +0.025/+0.076 (mm) | 76.200 +0.076/+0.127 | 63.500 +/-0.190 | BP0699-0762-0635-BSLT |
| 69.850 (2.750") +0.051/+0.102 (mm) | 76.200 +0.076/+0.127 | 63.500 +/-0.190 | BP0699-0762-0635-BSTT |
| 69.850 (2.750") +0.025/+0.076 (mm) | 79.375 +0.051/+0.102 | 31.750 +/-0.127 | BP0699-0794-0318-BSLT |
| 69.850 (2.750") +0.025/+0.076 (mm) | 79.375 +0.051/+0.102 | 69.850 +/-0.190 | BP0699-0794-0699-BSLT |
| 69.850 (2.750") +0.025/+0.076 (mm) | 79.375 +0.051/+0.102 | 101.600 +/-0.254 | BP0699-0794-1016-BSLT |
| 69.850 (2.750") +0.000/+0.051 (mm) | 82.550 +0.051/+0.102 | 38.100 +/-0.127 | BP0699-0826-0381-BSLT |
| 69.850 (2.750") +0.000/+0.051 (mm) | 82.550 +0.051/+0.102 | 50.800 | BP0699-0826-0508-BSLT |
| 69.850 (2.750") +0.051/+0.102 (mm) | 82.550 +0.076/+0.127 | 50.800 +/-0.190 | BP0699-0826-0508-BSTT1 |
| 69.850 (2.750") +0.076/+0.127 (mm) | 82.550 +0.076/+0.127 | 50.800 +/-0.190 | BP0699-0826-0508-BSTT2 |
| 69.850 (2.750") +0.076/+0.127 (mm) | 82.550 +0.127/+0.178 | 50.800 +/-0.190 | BP0699-0826-0508-BSTH |
| 69.850 (2.750") +0.000/+0.051 (mm) | 82.550 +0.051/+0.102 | 76.200 | BP0699-0826-0762-BSLT |



Stocked or Short Delivery



Usually Available Short Delivery



Long delivery or not in current production

* Large Minimum Quantities

** Available only while stock lasts

Bushes - Plain

| Nominal ID (d) mm (inches) | Nominal OD (D) mm | Length (S) mm | Part Number |
|---------------------------------------|--------------------------|---------------------|-------------------------------|
| 69.850 (2.750") +0.051/+0.102 (mm) | 82.550 +0.076/+0.127 | 76.200 +/-0.190 | BP0699-0826-0762-BSTT1 |
| 69.850 (2.750") +0.076/+0.127 (mm) | 82.550 +0.076/+0.127 | 76.200 +/-0.190 | BP0699-0826-0762-BSTT2 |
| 69.850 (2.750") +0.076/+0.127 (mm) | 82.550 +0.127/+0.178 | 76.200 +/-0.190 | BP0699-0826-0762-BSTH |
| 69.850 (2.750") +0.000/+0.051 (mm) | 82.550 +0.051/+0.102 | 101.600 +/-0.254 | BP0699-0826-1016-BSLT |
| 69.850 (2.750") +0.051/+0.102 (mm) | 82.550 +0.076/+0.127 | 101.600 +/-0.254 | BP0699-0826-1016-BSTT1 |
| 69.850 (2.750") +0.076/+0.127 (mm) | 82.550 +0.076/+0.127 | 101.600 +/-0.254 | BP0699-0826-1016-BSTT2 |
| 69.850 (2.750") +0.076/+0.127 (mm) | 82.550 +0.127/+0.178 | 101.600 +/-0.254 | BP0699-0826-1016-BSTH |
| 74.613 (2.938") +0.013/+0.064 (mm) | 84.138 +0.013/+0.064 | 76.200 +/-0.190 | BP0746-0841-0762-BSLL |
| 76.200 (3.000") +0.000/+0.051 (mm) | 82.550 +0.076/+0.127 | 31.750 +/-0.127 | BP0762-0826-0318-BSLT |
| 76.200 (3.000") +0.000/+0.051 (mm) | 82.550 +0.076/+0.127 | 50.800 +/-0.190 | BP0762-0826-0508-BSLT |
| 76.200 (3.000") +0.076/+0.127 (mm) | 82.550 +0.076/+0.127 | 50.800 +/-0.190 | BP0762-0826-0508-BSTT |
| 76.200 (3.000") +0.102/+0.152 (mm) | 82.550 +0.127/+0.178 | 50.800 +/-0.190 | BP0762-0826-0508-BSHH |
| 76.200 (3.000") +0.000/+0.051 (mm) | 82.550 +0.076/+0.127 | 76.200 +/-0.190 | BP0762-0826-0762-BSLT |
| 76.200 (3.000") +0.076/+0.127 (mm) | 82.550 +0.076/+0.127 | 76.200 +/-0.190 | BP0762-0826-0762-BSTT |
| 76.200 (3.000") +0.102/+0.152 (mm) | 82.550 +0.127/+0.178 | 76.200 +/-0.190 | BP0762-0826-0762-BSHH |
| 76.200 (3.000") +0.076/+0.127 (mm) | 88.900 +0.076/+0.127 | 50.800 +/-0.190 | BP0762-0889-0508-BSTT |
| 76.200 (3.000") +0.102/+0.152 (mm) | 88.900 +0.127/+0.178 | 50.800 +/-0.190 | BP0762-0889-0508-BSHH |
| 76.200 (3.000") +0.051/+0.102 (mm) | 88.900 +0.076/+0.127 | 63.500 +/-0.190 | BP0762-0889-0635-BSTT1 |
| 76.200 (3.000") +0.076/+0.127 (mm) | 88.900 +0.076/+0.127 | 63.500 +/-0.190 | BP0762-0889-0635-BSTT2 |
| 76.200 (3.000") +0.102/+0.152 (mm) | 88.900 +0.127/+0.178 | 63.500 +/-0.190 | BP0762-0889-0635-BSHH |
| 76.200 (3.000") +0.051/+0.102 (mm) | 88.900 +0.076/+0.127 | 76.200 +/-0.190 | BP0762-0889-0762-BSTT1 |
| 76.200 (3.000") +0.076/+0.127 (mm) | 88.900 +0.076/+0.127 | 76.200 +/-0.190 | BP0762-0889-0762-BSTT2 |
| 76.200 (3.000") +0.102/+0.152 (mm) | 88.900 +0.127/+0.178 | 76.200 +/-0.190 | BP0762-0889-0762-BSHH |
| 76.200 (3.000") +0.051/+0.102 (mm) | 88.900 +0.076/+0.127 | 101.600 +/-0.254 | BP0762-0889-1016-BSTT1 |
| 76.200 (3.000") +0.076/+0.127 (mm) | 88.900 +0.076/+0.127 | 101.600 +/-0.254 | BP0762-0889-1016-BSTT2 |
| 76.200 (3.000") +0.102/+0.152 (mm) | 88.900 +0.127/+0.178 | 101.600 +/-0.254 | BP0762-0889-1016-BSHH |
| 82.550 (3.250") +0.025/+0.076 (mm) | 92.075 +0.013/+0.076 | 101.600 +/-0.254 | BP0826-0921-1016-BSLL |
| 88.900 (3.500") +0.038/+0.089 (mm) | 101.600 +0.038/+0.102 | 50.800 +/-0.190 | BP0889-1016-0508-BSLL |
| 88.900 (3.500") +0.127/+0.178 (mm) | 101.600 +0.140/+0.203 | 50.800 +/-0.190 | BP0889-1016-0508-BSHH |
| 88.900 (3.500") +0.038/+0.089 (mm) | 101.600 +0.038/+0.102 | 76.200 +/-0.190 | BP0889-1016-0762-BSLL |
| 88.900 (3.500") +0.076/+0.127 (mm) | 101.600 +0.089/+0.152 | 76.200 +/-0.190 | BP0889-1016-0762-BSTT |
| 88.900 (3.500") +0.127/+0.178 (mm) | 101.600 +0.140/+0.203 | 76.200 +/-0.190 | BP0889-1016-0762-BSHH |
| 88.900 (3.500") +0.038/+0.089 (mm) | 101.600 +0.038/+0.102 | 88.900 +/-0.190 | BP0889-1016-0889-BSLL |
| 88.900 (3.500") +0.076/+0.127 (mm) | 101.600 +0.089/+0.152 | 88.900 +/-0.254 | BP0889-1016-0889-BSTT |

Stocked or Short Delivery
 Usually Available Short Delivery
 Long delivery or not in current production

* Large Minimum Quantities

** Available only while stock lasts

Bushes - Plain

| Nominal ID (d) mm (inches) | Nominal OD (D) mm | Length (S) mm | Part Number |
|--|--------------------------|---------------------|------------------------------|
| 88.900 (3.500") +0.127/+0.178 (mm) | 101.600 +0.140/+0.203 | 88.900 +/-0.254 | BP0889-1016-0889-BSHH |
| 88.900 (3.500") +0.038/+0.089 (mm) | 101.600 +0.038/+0.102 | 101.600 | BP0889-1016-1016-BSLL |
| 88.900 (3.500") +0.076/+0.127 (mm) | 101.600 +0.089/+0.152 | 101.600 +/-0.254 | BP0889-1016-1016-BSTT |
| 88.900 (3.500") +0.127/+0.178 (mm) | 101.600 +0.140/+0.203 | 101.600 +/-0.254 | BP0889-1016-1016-BSHH |
| 101.600 (4.000") +0.025/+0.089 (mm) | 114.300 +0.038/+0.102 | 101.600 | BP1016-1143-1016-BSLL |
| 101.600 (4.000") +0.140/+0.203 (mm) | 114.300 +0.165/+0.229 | 101.600 +/-0.254 | BP1016-1143-1016-BSHH |
| 101.600 (4.000") +0.025/+0.089 (mm) | 114.300 +0.038/+0.102 | 152.400 +/-0.381 | BP1016-1143-1524-BSLL |
| 101.600 (4.000") +0.013/+0.076 (mm) | 117.475 -0.013/+0.076 | 101.600 +/-0.254 | BP1016-1175-1016-BSLU |
| 114.300 (4.500") +0.038/+0.102 (mm) | 133.350 +0.025/+0.114 | 127.000 +/-0.381 | BP1143-1334-1270-BSLL |
| 127.000 (5.000") +0.013/+0.102 (mm) | 146.050 +0.025/+0.127 | 50.800 +/-0.190 | BP1270-1461-0508-BSLL |

Bushes - Spherical OD

| Nominal ID (d) mm (inches) | Nominal OD (D) mm | Length (S) mm | Part Number |
|-------------------------------|----------------------|---------------|----------------------------------|
| 4.000 (0.157") | 9.500 | 8.000 | * BSP00400-00950-0080-SB |
| 5.000 (0.197") | 12.500 | 10.000 | * BSP00500-01250-0100-SB |
| 6.000 (0.236") | 14.500 | 11.000 | ** BSP00600-01450-0110-SB |
| 7.000 (0.276") | 15.500 | 11.000 | ** BSP00700-01550-0110-SB |
| 8.000 (0.315") | 15.500 | 11.000 | ** BSP00800-01550-0110-SB |
| 10.000 (0.394") | 21.000 | 14.000 | * BSP01000-02100-0140-SB |
| 12.000 (0.472") | 24.000 | 16.000 | * BSP01200-02400-0160-SB |

Rod

| Nom. Dia (D) mm (inches) | Length (L) mm | Grade | Part Number |
|------------------------------------|---------------|---------|------------------------|
| 6.35 (0.250") +0.15/+3.20 (mm) | 31.8 | SAE 841 | * 0R-0064-0032-SB |
| 6.35 (0.250") +0.15/+3.20 (mm) | 50.8 | SAE 841 | 0R-0064-0051-SB |
| 9.53 (0.375") +0.15/+3.20 (mm) | 38.0 | SAE 841 | * 0R-0095-0038-SB |
| 9.53 (0.375") +0.15/+3.20 (mm) | 76.2 | SAE 841 | 0R-0095-0076-SB |
| 12.70 (0.500") +0.15/+3.20 (mm) | 38.8 | SAE 841 | * 0R-0127-0039-SB |
| 12.70 (0.500") +0.15/+3.20 (mm) | 165.1 | SAE 841 | 0R-0127-0165-SB |
| 15.88 (0.625") +0.15/+3.20 (mm) | 51.0 | SAE 841 | * 0R-0159-0051-SB |
| 15.88 (0.625") +0.15/+3.20 (mm) | 165.1 | SAE 841 | 0R-0159-0165-SB |
| 19.05 (0.750") +0.15/+3.20 (mm) | 51.0 | SAE 841 | * 0R-0191-0051-SB |
| 19.05 (0.750") +0.15/+3.20 (mm) | 165.1 | SAE 841 | 0R-0191-0165-SB |
| 22.23 (0.875") +0.15/+3.20 (mm) | 51.0 | SAE 841 | * 0R-0222-0051-SB |
| 22.23 (0.875") +0.15/+3.20 (mm) | 165.1 | SAE 841 | 0R-0222-0165-SB |
| 25.40 (1.000") +0.15/+3.20 (mm) | 63.5 | SAE 841 | * 0R-0254-0064-SB |
| 25.40 (1.000") +0.15/+3.20 (mm) | 165.1 | SAE 841 | 0R-0254-0165-SB |
| 28.58 (1.125") +0.15/+3.20 (mm) | 108.0 | SAE 841 | * 0R-0286-0108-SB |
| 28.58 (1.125") +0.15/+3.20 (mm) | 165.1 | SAE 841 | 0R-0286-0165-SB |



Stocked or Short Delivery



Usually Available Short Delivery



Long delivery or not in current production

* Large Minimum Quantities

** Available only while stock lasts

| Rod | | | |
|-------------------------------------|---------------|---------|-------------------|
| Nom. Dia (D) mm (inches) | Length (L) mm | Grade | Part Number |
| 31.75 (1.250") +0.15/+3.20 (mm) | 63.5 | SAE 841 | * 0R-0318-0064-SB |
| 31.75 (1.250") +0.15/+3.20 (mm) | 165.1 | SAE 841 | 0R-0318-0165-SB |
| 34.93 (1.375") +0.15/+3.20 (mm) | 69.9 | SAE 841 | * 0R-0349-0070-SB |
| 34.93 (1.375") +0.15/+3.20 (mm) | 165.1 | SAE 841 | 0R-0349-0165-SB |
| 38.10 (1.500") +0.15/+3.20 (mm) | 165.1 | SAE 841 | 0R-0381-0165-SB |
| 41.28 (1.625") +0.15/+3.20 (mm) | 69.9 | SAE 841 | * 0R-0413-0070-SB |
| 41.28 (1.625") +0.15/+3.20 (mm) | 165.1 | SAE 841 | 0R-0413-0165-SB |
| 44.45 (1.750") +0.15/+3.20 (mm) | 165.1 | SAE 841 | 0R-0445-0165-SB |
| 50.80 (2.000") +0.15/+3.20 (mm) | 165.1 | SAE 841 | 0R-0508-0165-SB |
| 57.15 (2.250") +0.15/+3.20 (mm) | 165.1 | SAE 841 | 0R-0572-0165-SB |
| 63.50 (2.500") +0.15/+3.20 (mm) | 165.1 | SAE 841 | 0R-0635-0165-SB |
| 69.85 (2.750") +0.15/+3.20 (mm) | 165.1 | SAE 841 | * 0R-0699-0165-SB |
| 76.20 (3.000") +0.15/+3.20 (mm) | 165.1 | SAE 841 | 0R-0762-0165-SB |
| 82.55 (3.250") +0.15/+3.20 (mm) | 165.1 | SAE 841 | * 0R-0826-0165-SB |
| 88.90 (3.500") +0.15/+3.20 (mm) | 165.1 | SAE 841 | * 0R-0889-0165-SB |
| 101.60 (4.000") +0.15/+3.20 (mm) | 165.1 | SAE 841 | 0R-1016-0165-SB |
| 114.30 (4.500") +0.15/+3.20 (mm) | 165.1 | SAE 841 | * 0R-1143-0165-SB |
| 127.00 (5.000") +0.15/+3.20 (mm) | 165.1 | SAE 841 | * 0R-1270-0165-SB |
| 139.70 (5.500") +0.15/+3.20 (mm) | 152.4 | SAE 841 | * 0R-1397-0152-SB |
| 152.40 (6.000") +0.15/+3.20 (mm) | 152.4 | SAE 841 | * 0R-1524-0152-SB |
| 177.80 (7.000") +0.15/+3.20 (mm) | 152.40 | SAE 841 | 0R-1778-0152-SB |
| 203.20 (8.000") +0.15/+3.20 (mm) | 165.1 | SAE 841 | 0R-2032-0165-SB |

| Sheet | | | |
|--------------------------|----------|-----------|--------------------------|
| Thickness mm (inches) | Width mm | Length mm | Part Number |
| 3.18 (0.125") | 25.4 | 108.0 | ** SHT-0318-0025-0108-SB |
| 3.18 (0.125") | 127.00 | 152.40 | SHT-0318-0127-0152-SB |
| 3.18 (0.125") | 152.40 | 304.80 | SHT-0318-0152-0305-SB |
| 4.76 (0.187") | 152.40 | 304.80 | SHT-0476-0152-0305-SB |
| 6.35 (0.250") | 50.80 | 206.38 | SHT-0635-0051-0206-SB |
| 6.35 (0.250") | 127.00 | 203.20 | SHT-0635-0127-0203-SB |
| 6.35 (0.250") | 152.4 | 305.0 | SHT-0635-0152-0305-SB |
| 6.35 (0.250") | 254.0 | 254.0 | SHT-0635-0254-0254-SB |
| 12.70 (0.500") | 50.80 | 206.38 | * SHT-1270-0051-0206-SB |
| 19.05 (0.750") | 127.00 | 203.20 | SHT-1905-0127-0203-SB |
| 19.05 (0.750") | 152.40 | 304.80 | SHT-1905-0152-0305-SB |

| Tube | | | | |
|------------------------------------|----------------------|---------------|------|----------------------|
| Nom. OD mm (inches) | Nom. ID mm | Length (L) mm | Info | Part Number |
| 25.40 (1.000") +0.80/+3.20 (mm) | 12.70 -0.80/-3.20 | 165.1 | | 0T-0254-0127-0165-SB |
| 25.40 (1.000") +0.80/+3.20 (mm) | 15.88 -0.80/-3.20 | 165.1 | | 0T-0254-0159-0165-SB |

Stocked or Short Delivery
 Usually Available Short Delivery
 Long delivery or not in current production

* Large Minimum Quantities ** Available only while stock lasts

| Tube | | | | |
|------------------------|-------------|---------------|------|----------------------|
| Nom. OD mm (inches) | Nom. ID mm | Length (L) mm | Info | Part Number |
| 28.58 (1.125") | 12.70 | 165.1 | | 0T-0286-0127-0165-SB |
| +0.80/+3.20 (mm) | -0.80/-3.20 | | | |
| 28.58 (1.125") | 15.88 | 165.1 | | 0T-0286-0159-0165-SB |
| +0.80/+3.20 (mm) | -0.80/-3.20 | | | |
| 31.75 (1.250") | 12.70 | 165.1 | | 0T-0318-0127-0165-SB |
| +0.80/+3.20 (mm) | -0.80/-3.20 | | | |
| 31.75 (1.250") | 15.88 | 165.1 | | 0T-0318-0159-0165-SB |
| +0.80/+3.20 (mm) | -0.80/-3.20 | | | |
| 31.75 (1.250") | 19.05 | 165.1 | | 0T-0318-0191-0165-SB |
| +0.80/+3.20 (mm) | -0.80/-3.20 | | | |
| 34.93 (1.375") | 15.88 | 165.1 | | 0T-0349-0159-0165-SB |
| +0.80/+3.20 (mm) | -0.80/-3.20 | | | |
| 34.93 (1.375") | 22.23 | 165.1 | | 0T-0349-0222-0165-SB |
| +0.80/+3.20 (mm) | -0.80/-3.20 | | | |
| 38.10 (1.500") | 12.70 | 165.1 | | 0T-0381-0127-0165-SB |
| +0.80/+3.20 (mm) | -0.80/-3.20 | | | |
| 38.10 (1.500") | 15.88 | 165.1 | | 0T-0381-0159-0165-SB |
| +0.80/+3.20 (mm) | -0.80/-3.20 | | | |
| 38.10 (1.500") | 19.05 | 165.1 | | 0T-0381-0191-0165-SB |
| +0.80/+3.20 (mm) | -0.80/-3.20 | | | |
| 38.10 (1.500") | 22.23 | 165.1 | | 0T-0381-0222-0165-SB |
| +0.80/+3.20 (mm) | -0.80/-3.20 | | | |
| 38.10 (1.500") | 25.40 | 165.1 | | 0T-0381-0254-0165-SB |
| +0.80/+3.20 (mm) | -0.80/-3.20 | | | |
| 41.28 (1.625") | 25.40 | 165.1 | | 0T-0413-0254-0165-SB |
| +0.80/+3.20 (mm) | -0.80/-3.20 | | | |
| 44.45 (1.750") | 15.88 | 165.1 | | 0T-0445-0159-0165-SB |
| +0.80/+3.20 (mm) | -0.80/-3.20 | | | |
| 44.45 (1.750") | 19.05 | 165.1 | | 0T-0445-0191-0165-SB |
| +0.80/+3.20 (mm) | -0.80/-3.20 | | | |
| 44.45 (1.750") | 25.40 | 165.1 | | 0T-0445-0254-0165-SB |
| +0.80/+3.20 (mm) | -0.80/-3.20 | | | |
| 44.45 (1.750") | 31.75 | 165.1 | | 0T-0445-0318-0165-SB |
| +0.80/+3.20 (mm) | -0.80/-3.20 | | | |
| 50.80 (2.000") | 12.70 | 165.1 | | 0T-0508-0127-0165-SB |
| +0.80/+3.20 (mm) | -0.80/-3.20 | | | |
| 50.80 (2.000") | 15.88 | 165.1 | | 0T-0508-0159-0165-SB |
| +0.80/+3.20 (mm) | -0.80/-3.20 | | | |
| 50.80 (2.000") | 19.05 | 165.1 | | 0T-0508-0191-0165-SB |
| +0.80/+3.20 (mm) | -0.80/-3.20 | | | |
| 50.80 (2.000") | 22.23 | 165.1 | | 0T-0508-0222-0165-SB |
| +0.80/+3.20 (mm) | -0.80/-3.20 | | | |
| 50.80 (2.000") | 25.40 | 165.1 | | 0T-0508-0254-0165-SB |
| +0.80/+3.20 (mm) | -0.80/-3.20 | | | |
| 50.80 (2.000") | 31.75 | 165.1 | | 0T-0508-0318-0165-SB |
| +0.80/+3.20 (mm) | -0.80/-3.20 | | | |
| 50.80 (2.000") | 34.93 | 165.1 | | 0T-0508-0349-0165-SB |
| +0.80/+3.20 (mm) | -0.80/-3.20 | | | |
| 50.80 (2.000") | 38.10 | 165.1 | | 0T-0508-0381-0165-SB |
| +0.80/+3.20 (mm) | -0.80/-3.20 | | | |
| 53.98 (2.125") | 28.58 | 165.1 | | 0T-0540-0286-0165-SB |
| +0.80/+3.20 (mm) | -0.80/-3.20 | | | |
| 57.15 (2.250") | 19.05 | 165.1 | | 0T-0572-0191-0165-SB |
| +0.80/+3.20 (mm) | -0.80/-3.20 | | | |
| 57.15 (2.250") | 22.23 | 165.1 | | 0T-0572-0222-0165-SB |
| +0.80/+3.20 (mm) | -0.80/-3.20 | | | |
| 57.15 (2.250") | 25.40 | 165.1 | | 0T-0572-0254-0165-SB |
| +0.80/+3.20 (mm) | -0.80/-3.20 | | | |
| 57.15 (2.250") | 31.75 | 165.1 | | 0T-0572-0318-0165-SB |
| +0.80/+3.20 (mm) | -0.80/-3.20 | | | |
| 57.15 (2.250") | 38.10 | 165.1 | | 0T-0572-0381-0165-SB |
| +0.80/+3.20 (mm) | -0.80/-3.20 | | | |
| 57.15 (2.250") | 44.45 | 165.1 | | 0T-0572-0445-0165-SB |
| +0.80/+3.20 (mm) | -0.80/-3.20 | | | |
| 63.50 (2.500") | 19.05 | 165.1 | | 0T-0635-0191-0165-SB |
| +0.80/+3.20 (mm) | -0.80/-3.20 | | | |

| Tube | | | | |
|------------------------|-------------|---------------|------|----------------------|
| Nom. OD mm (inches) | Nom. ID mm | Length (L) mm | Info | Part Number |
| 63.50 (2.500") | 25.40 | 165.1 | | 0T-0635-0254-0165-SB |
| +0.80/+3.20 (mm) | -0.80/-3.20 | | | |
| 63.50 (2.500") | 31.75 | 165.1 | | 0T-0635-0318-0165-SB |
| +0.80/+3.20 (mm) | -0.80/-3.20 | | | |
| 63.50 (2.500") | 38.10 | 165.1 | | 0T-0635-0381-0165-SB |
| +0.80/+3.20 (mm) | -0.80/-3.20 | | | |
| 63.50 (2.500") | 44.45 | 165.1 | | 0T-0635-0445-0165-SB |
| +0.80/+3.20 (mm) | -0.80/-3.20 | | | |
| 66.68 (2.625") | 44.45 | 165.1 | | 0T-0667-0445-0165-SB |
| +0.80/+3.20 (mm) | -0.80/-3.20 | | | |
| 69.85 (2.750") | 19.05 | 165.1 | | 0T-0699-0191-0165-SB |
| +0.80/+3.20 (mm) | -0.80/-3.20 | | | |
| 69.85 (2.750") | 34.93 | 165.1 | | 0T-0699-0349-0165-SB |
| +0.80/+3.20 (mm) | -0.80/-3.20 | | | |
| 69.85 (2.750") | 38.10 | 165.1 | | 0T-0699-0381-0165-SB |
| +0.80/+3.20 (mm) | -0.80/-3.20 | | | |
| 69.85 (2.750") | 44.45 | 165.1 | | 0T-0699-0445-0165-SB |
| +0.80/+3.20 (mm) | -0.80/-3.20 | | | |
| 69.85 (2.750") | 50.80 | 165.1 | | 0T-0699-0508-0165-SB |
| +0.80/+3.20 (mm) | -0.80/-3.20 | | | |
| 76.20 (3.000") | 25.40 | 165.1 | | 0T-0762-0254-0165-SB |
| +0.80/+3.20 (mm) | -0.80/-3.20 | | | |
| 76.20 (3.000") | 31.75 | 165.1 | | 0T-0762-0318-0165-SB |
| +0.80/+3.20 (mm) | -0.80/-3.20 | | | |
| 76.20 (3.000") | 38.10 | 165.1 | | 0T-0762-0381-0165-SB |
| +0.80/+3.20 (mm) | -0.80/-3.20 | | | |
| 76.20 (3.000") | 44.45 | 165.1 | | 0T-0762-0445-0165-SB |
| +0.80/+3.20 (mm) | -0.80/-3.20 | | | |
| 76.20 (3.000") | 50.80 | 165.1 | | 0T-0762-0508-0165-SB |
| +0.80/+3.20 (mm) | -0.80/-3.20 | | | |
| 76.20 (3.000") | 57.15 | 165.1 | | 0T-0762-0572-0165-SB |
| +0.80/+3.20 (mm) | -0.80/-3.20 | | | |
| 76.20 (3.000") | 60.33 | 165.1 | | 0T-0762-0603-0165-SB |
| +0.80/+3.20 (mm) | -0.80/-3.20 | | | |
| 82.55 (3.250") | 50.80 | 165.1 | | 0T-0826-0508-0165-SB |
| +0.80/+3.20 (mm) | -0.80/-3.20 | | | |
| 82.55 (3.250") | 57.15 | 165.1 | | 0T-0826-0572-0165-SB |
| +0.80/+3.20 (mm) | -0.80/-3.20 | | | |
| 88.90 (3.500") | 25.40 | 165.1 | | 0T-0889-0254-0165-SB |
| +0.80/+3.20 (mm) | -0.80/-3.20 | | | |
| 88.90 (3.500") | 31.75 | 165.1 | | 0T-0889-0318-0165-SB |
| +0.80/+3.20 (mm) | -0.80/-3.20 | | | |
| 88.90 (3.500") | 38.10 | 165.1 | | 0T-0889-0381-0165-SB |
| +0.80/+3.20 (mm) | -0.80/-3.20 | | | |
| 88.90 (3.500") | 44.45 | 165.1 | | 0T-0889-0445-0165-SB |
| +0.80/+3.20 (mm) | -0.80/-3.20 | | | |
| 88.90 (3.500") | 57.15 | 165.1 | | 0T-0889-0572-0165-SB |
| +0.80/+3.20 (mm) | -0.80/-3.20 | | | |
| 88.90 (3.500") | 60.33 | 165.1 | | 0T-0889-0603-0165-SB |
| +0.80/+3.20 (mm) | -0.80/-3.20 | | | |
| 88.90 (3.500") | 63.50 | 165.1 | | 0T-0889-0635-0165-SB |
| +0.80/+3.20 (mm) | -0.80/-3.20 | | | |
| 95.25 (3.750") | 57.15 | 165.1 | | 0T-0953-0572-0165-SB |
| +0.80/+3.20 (mm) | -0.80/-3.20 | | | |
| 95.25 (3.750") | 63.50 | 165.1 | | 0T-0953-0635-0165-SB |
| +0.80/+3.20 (mm) | -0.80/-3.20 | | | |
| 95.25 (3.750") | 69.85 | 165.1 | | 0T-0953-0699-0165-SB |
| +0.80/+3.20 (mm) | -0.80/-3.20 | | | |
| 95.25 (3.750") | 76.20 | 165.1 | | 0T-0953-0762-0165-SB |
| +0.80/+3.20 (mm) | -0.80/-3.20 | | | |
| 101.60 (4.000") | 25.40 | 165.1 | | 0T-1016-0254-0165-SB |
| +0.80/+3.20 (mm) | -0.80/-3.20 | | | |
| 101.60 (4.000") | 31.75 | 165.1 | | 0T-1016-0318-0165-SB |
| +0.80/+3.20 (mm) | -0.80/-3.20 | | | |
| 101.60 (4.000") | 38.10 | 165.1 | | 0T-1016-0381-0165-SB |
| +0.80/+3.20 (mm) | -0.80/-3.20 | | | |

| Tube | | | | | |
|-------------------------------------|-----------------------|---------------|---|-------------------------|--|
| Nom. OD mm (inches) | Nom. ID mm | Length (L) mm | Info | Part Number | |
| 101.60 (4.000") +0.80/+3.20 (mm) | 50.80 -0.80/-3.20 | 165.1 | | 0T-1016-0508-0165-SB | |
| 101.60 (4.000") +0.80/+3.20 (mm) | 57.15 -0.80/-3.20 | 165.1 | | 0T-1016-0572-0165-SB | |
| 101.60 (4.000") +0.80/+3.20 (mm) | 60.33 -0.80/-3.20 | 165.1 | | 0T-1016-0603-0165-SB | |
| 101.60 (4.000") +0.80/+3.20 (mm) | 63.50 -0.80/-3.20 | 165.1 | | 0T-1016-0635-0165-SB | |
| 101.60 (4.000") +0.80/+3.20 (mm) | 76.20 -0.80/-3.20 | 165.1 | | 0T-1016-0762-0165-SB | |
| 107.95 (4.250") +0.80/+3.20 (mm) | 44.45 -0.80/-3.20 | 165.1 | | 0T-1080-0445-0165-SB | |
| 107.95 (4.250") +0.80/+3.20 (mm) | 63.50 -0.80/-3.20 | 165.1 | | 0T-1080-0635-0165-SB | |
| 107.95 (4.250") +0.80/+3.20 (mm) | 82.55 -0.80/-3.20 | 165.1 | | 0T-1080-0826-0165-SB | |
| 114.30 (4.500") +0.80/+3.20 (mm) | 44.45 -0.80/-3.20 | 165.1 | | 0T-1143-0445-0165-SB | |
| 114.30 (4.500") +0.80/+3.20 (mm) | 50.80 -0.80/-3.20 | 165.1 | | 0T-1143-0508-0165-SB | |
| 114.30 (4.500") +0.80/+3.20 (mm) | 57.15 -0.80/-3.20 | 165.1 | | 0T-1143-0572-0165-SB | |
| 114.30 (4.500") +0.80/+3.20 (mm) | 57.15 -0.80/-3.20 | 165.1 | This is 4.5 inch OD with a small dent in the OD. Suitable to machine to 110mm or less | ** 0T-1100-0572-0165-SB | |
| 114.30 (4.500") +0.80/+3.20 (mm) | 60.33 -0.80/-3.20 | 165.1 | | 0T-1143-0603-0165-SB | |
| 114.30 (4.500") +0.80/+3.20 (mm) | 63.50 -0.80/-3.20 | 165.1 | | 0T-1143-0635-0165-SB | |
| 114.30 (4.500") +0.80/+3.20 (mm) | 76.20 -0.80/-3.20 | 165.1 | | 0T-1143-0762-0165-SB | |
| 120.65 (4.750") +0.80/+3.20 (mm) | 88.90 -0.80/-3.20 | 165.1 | | 0T-1207-0889-0165-SB | |
| 127.00 (5.000") +0.80/+3.20 (mm) | 50.80 -0.80/-3.20 | 165.1 | | 0T-1270-0508-0165-SB | |
| 127.00 (5.000") +0.80/+3.20 (mm) | 63.50 -0.80/-3.20 | 165.1 | | 0T-1270-0635-0165-SB | |
| 127.00 (5.000") +0.80/+3.20 (mm) | 76.20 -0.80/-3.20 | 165.1 | | 0T-1270-0762-0165-SB | |
| 127.00 (5.000") +0.80/+3.20 (mm) | 88.90 -0.80/-3.20 | 165.1 | | 0T-1270-0889-0165-SB | |
| 127.00 (5.000") +0.80/+3.20 (mm) | 95.25 -0.80/-3.20 | 165.1 | | 0T-1270-0953-0165-SB | |
| 139.70 (5.500") +0.80/+3.20 (mm) | 50.80 -0.80/-3.20 | 165.1 | | 0T-1397-0508-0165-SB | |
| 139.70 (5.500") +0.80/+3.20 (mm) | 101.60 -0.80/-3.20 | 165.1 | | 0T-1397-1016-0165-SB | |
| 150.00 (5.906") +0.80/+3.20 (mm) | 76.20 -0.80/-3.20 | 165.1 | This is 6 inch OD with a small dent in the OD. Suitable to machine to 150mm or less | ** 0T-1500-0762-0165-SB | |
| 152.40 (6.000") +0.80/+3.20 (mm) | 76.20 -0.80/-3.20 | 165.1 | | 0T-1524-0762-0165-SB | |
| 152.40 (6.000") +0.80/+3.20 (mm) | 88.90 -0.80/-3.20 | 165.1 | | 0T-1524-0889-0165-SB | |
| 152.40 (6.000") +0.80/+3.20 (mm) | 101.60 -0.80/-3.20 | 165.1 | | 0T-1524-1016-0165-SB | |
| 152.40 (6.000") +0.80/+3.20 (mm) | 114.30 -0.80/-3.20 | 165.1 | | 0T-1524-1143-0165-SB | |
| 177.80 (7.000") +0.80/+3.20 (mm) | 101.60 -0.80/-3.20 | 165.1 | | 0T-1778-1016-0165-SB | |
| 177.80 (7.000") +0.80/+3.20 (mm) | 127.00 -0.80/-3.20 | 165.1 | | 0T-1778-1270-0165-SB | |
| 203.20 (8.000") +0.80/+3.20 (mm) | 101.60 -0.80/-3.20 | 165.10 | | 0T-2032-1016-0165-SB | |

Stocked or Short Delivery
 Usually Available Short Delivery
 Long delivery or not in current production

* Large Minimum Quantities

** Available only while stock lasts

| Tube | | | | |
|--------------------------------------|-----------------------|---------------|------|----------------------|
| Nom. OD mm (inches) | Nom. ID mm | Length (L) mm | Info | Part Number |
| 203.20 (8.000") +0.80/+3.20 (mm) | 152.40 -0.80/-3.20 | 165.1 | | 0T-2032-1524-0165-SB |
| 228.60 (9.000") +0.80/+3.20 (mm) | 177.80 -0.80/-3.20 | 165.1 | | 0T-2286-1778-0165-SB |
| 263.53 (10.375") +0.80/+3.20 (mm) | 196.85 -0.80/-3.20 | 155.60 | | 0T-2635-1969-0156-SB |

| Washers | | | | |
|-------------------------------------|------------------|------------------|---------------|----------------------|
| Nom. ID (d) mm (inches) | OD (D) mm | Thickness (T) mm | Other | Part Number |
| 3.000 (0.118") 0.01/0.33 (mm) | 9.50 +/-0.25 | 1.60 +/-0.07 | Thrust Washer | W0030-F-010-016-SB |
| 3.175 (0.125") +0.12/+0.25 (mm) | 9.40 +/-0.25 | 1.58 +/-0.064 | Thrust Washer | W0032-F-009-016-SB |
| 4.000 (0.157") +0.02/+0.43 (mm) | 9.50 +/-0.25 | 1.60 +/-0.07 | Thrust Washer | W0040-F-010-016-SB |
| 4.762 (0.187") +0.12/+0.25 (mm) | 12.57 +/-0.25 | 1.58 +/-0.064 | Thrust Washer | W0048-F-013-016-SB |
| 5.000 (0.197") +0.02/+0.43 (mm) | 12.50 +/-0.25 | 1.60 +/-0.07 | Thrust Washer | W0050-F-013-016-SB |
| 6.000 (0.236") +0.03/+0.53 (mm) | 12.50 +/-0.25 | 1.60 +/-0.07 | Thrust Washer | W0060-F-013-016-SB |
| 6.000 (0.236") +0.03/+0.53 (mm) | 15.88 +/-0.25 | 1.59 +/-0.07 | Thrust Washer | * W0060-F-016-016-SB |
| 6.350 (0.250") +0.00/+0.25 (mm) | 11.11 +/-0.25 | 1.59 +/-0.07 | Thrust Washer | W0064-F-011-016-SB |
| 6.350 (0.250") +0.00/+0.25 (mm) | 12.70 +/-0.25 | 1.59 +/-0.07 | Thrust Washer | W0064-F-013-016-SB |
| 6.350 (0.250") +0.00/+0.25 (mm) | 15.88 +/-0.25 | 1.59 +/-0.07 | Thrust Washer | W0064-F-016-016-SB |
| 7.938 (0.313") -0.08/+0.19 (mm) | 15.88 +/-0.25 | 1.59 +/-0.07 | Thrust Washer | W0079-F-016-016-SB |
| 7.938 (0.313") -0.06/+0.19 (mm) | 19.05 +/-0.25 | 1.59 +/-0.07 | Thrust Washer | W0079-F-019-016-SB |
| 8.000 (0.315") +0.03/+0.53 (mm) | 19.00 +/-0.25 | 1.60 +/-0.07 | Thrust Washer | W0080-F-019-016-SB |
| 9.525 (0.375") +0.13/+0.38 (mm) | 15.88 +/-0.25 | 1.59 +/-0.07 | Thrust Washer | W0095-F-016-016-SB |
| 9.525 (0.375") +0.25/+0.51 (mm) | 19.05 +/-0.25 | 0.79 +/-0.07 | Thrust Washer | W0095-F-019-008-SB |
| 9.525 (0.375") -0.06/+0.19 (mm) | 19.05 +/-0.25 | 1.59 +/-0.07 | Thrust Washer | W0095-F-019-016-SB |
| 9.525 (0.375") -0.06/+0.19 (mm) | 19.05 +/-0.25 | 3.18 +/-0.07 | Thrust Washer | W0095-F-019-032-SB |
| 10.000 (0.394") +0.04/+0.63 (mm) | 19.00 +/-0.25 | 1.60 +/-0.07 | Thrust Washer | W0100-F-019-016-SB |
| 10.000 (0.394") +0.04/+0.63 (mm) | 19.00 +/-0.25 | 3.20 +/-0.07 | Thrust Washer | W0100-F-019-032-SB |
| 11.111 (0.437") -0.10/+0.15 (mm) | 19.05 +/-0.25 | 1.59 +/-0.07 | Thrust Washer | W0111-F-019-016-SB |
| 11.111 (0.437") -0.06/+0.19 (mm) | 19.05 +/-0.25 | 3.18 +/-0.064 | Thrust Washer | W0111-F-019-032-SB |
| 12.000 (0.472") +0.87/+1.13 (mm) | 25.00 +/-0.25 | 1.60 +/-0.07 | Thrust Washer | W0120-F-025-016-SB |
| 12.000 (0.472") +0.87/+1.13 (mm) | 25.00 +/-0.25 | 3.20 +/-0.07 | Thrust Washer | W0120-F-025-032-SB |
| 12.700 (0.500") +0.05/+0.30 (mm) | 19.05 +/-0.25 | 1.59 +/-0.07 | Thrust Washer | W0127-F-019-016-SB |
| 12.700 (0.500") +0.00/+0.25 (mm) | 22.23 +/-0.25 | 4.76 +/-0.07 | Thrust Washer | W0127-F-022-048-SB |
| 12.700 (0.500") +0.13/+0.38 (mm) | 25.40 +/-0.25 | 1.58 +/-0.07 | Thrust Washer | W0127-F-025-016-SB |
| 12.700 (0.500") +0.13/+0.38 (mm) | 25.40 +/-0.25 | 2.38 +/-0.07 | Thrust Washer | W0127-F-025-024-SB |
| 12.700 (0.500") +0.13/+0.38 (mm) | 25.40 +/-0.25 | 3.18 +/-0.07 | Thrust Washer | W0127-F-025-032-SB |
| 14.287 (0.562") -0.06/+0.19 (mm) | 31.75 +/-0.25 | 1.59 +/-0.07 | Thrust Washer | W0143-F-032-016-SB |

Stocked or Short Delivery
 Usually Available Short Delivery
 Long delivery or not in current production

* Large Minimum Quantities

** Available only while stock lasts

Washers

| Nom. ID (d) mm (inches) | OD (D) mm | Thickness (T) mm | Other | Part Number |
|-------------------------------------|----------------------|------------------|---------------|--------------------|
| 14.287 (0.562") -0.06/+0.19 (mm) | 31.75 +/-0.25 | 3.18 +/-0.07 | Thrust Washer | W0143-F-032-032-SB |
| 15.875 (0.625") -0.05/+0.20 (mm) | 25.40 +/-0.25 | 1.59 +/-0.07 | Thrust Washer | W0159-F-025-016-SB |
| 15.875 (0.625") -0.05/+0.20 (mm) | 25.40 +/-0.25 | 3.18 +/-0.07 | Thrust Washer | W0159-F-025-032-SB |
| 15.875 (0.625") -0.08/+0.18 (mm) | 30.16 +/-0.25 | 1.59 +/-0.07 | Thrust Washer | W0159-F-030-016-SB |
| 15.875 (0.625") -0.08/+0.18 (mm) | 30.16 +/-0.27 | 2.38 +/-0.07 | Thrust Washer | W0159-F-030-024-SB |
| 15.875 (0.625") -0.08/+0.18 (mm) | 30.16 +/-0.25 | 3.18 +/-0.07 | Thrust Washer | W0159-F-030-032-SB |
| 15.875 (0.625") -0.05/+0.20 (mm) | 31.75 +/-0.25 | 1.59 +/-0.07 | Thrust Washer | W0159-F-032-016-SB |
| 15.875 (0.625") -0.05/+0.20 (mm) | 31.75 +/-0.25 | 3.18 +/-0.07 | Thrust Washer | W0159-F-032-032-SB |
| 16.000 (0.630") +0.53/+0.79 (mm) | 38.10 +/-0.25 | 1.59 +/-0.07 | Thrust Washer | W0160-F-038-016-SB |
| 16.000 (0.630") +0.53/+0.79 (mm) | 38.10 +/-0.25 | 3.18 +/-0.07 | Thrust Washer | W0160-F-038-032-SB |
| 19.050 (0.750") -0.05/+0.20 (mm) | 31.75 +/-0.25 | 1.59 +/-0.07 | Thrust Washer | W0191-F-032-016-SB |
| 19.050 (0.750") -0.09/+0.20 (mm) | 31.75 +/-0.25 | 3.18 +/-0.07 | Thrust Washer | W0191-F-032-032-SB |
| 19.050 (0.750") -0.05/+0.20 (mm) | 34.93 +/-0.25 | 1.59 +/-0.07 | Thrust Washer | W0191-F-035-016-SB |
| 19.050 (0.750") -0.08/+0.20 (mm) | 34.93 +/-0.25 | 3.18 +/-0.07 | Thrust Washer | W0191-F-035-032-SB |
| 19.050 (0.750") -0.05/+0.20 (mm) | 34.93 +/-0.25 | 6.35 +/-0.07 | Thrust Washer | W0191-F-035-064-SB |
| 19.050 (0.750") +0.25/+0.51 (mm) | 39.69 +/-0.27 | 2.38 +/-0.07 | Thrust Washer | W0191-F-040-024-SB |
| 22.225 (0.875") +0.27/+0.52 (mm) | 38.10 +/-0.25 | 1.59 +/-0.07 | Thrust Washer | W0222-F-038-016-SB |
| 22.225 (0.875") +0.25/+0.52 (mm) | 38.10 +/-0.25 | 3.18 +/-0.07 | Thrust Washer | W0222-F-038-032-SB |
| 22.225 (0.875") +0.00/+0.25 (mm) | 50.80 +/-0.25 | 3.18 +/-0.07 | Thrust Washer | W0222-F-051-032-SB |
| 22.225 (0.875") +0.25/+0.52 (mm) | 53.98 +/-0.25 | 3.18 +/-0.07 | Thrust Washer | W0222-F-054-032-SB |
| 25.400 (1.000") -0.05/+0.20 (mm) | 38.10 -0.15/+0.36 | 1.59 +/-0.07 | Thrust Washer | W0254-F-038-016-SB |
| 25.400 (1.000") -0.05/+0.20 (mm) | 38.10 -0.15/+0.36 | 3.18 +/-0.07 | Thrust Washer | W0254-F-038-032-SB |
| 25.400 (1.000") -0.05/+0.20 (mm) | 38.10 -0.15/+0.36 | 4.76 +/-0.07 | Thrust Washer | W0254-F-038-048-SB |
| 25.400 (1.000") +0.27/+0.52 (mm) | 41.28 +/-0.25 | 1.59 +/-0.07 | Thrust Washer | W0254-F-041-016-SB |
| 25.400 (1.000") +0.27/+0.52 (mm) | 41.28 +/-0.25 | 3.18 +/-0.07 | Thrust Washer | W0254-F-041-032-SB |
| 25.400 (1.000") -0.05/+0.20 (mm) | 41.28 -0.13/+0.38 | 6.35 +/-0.07 | Thrust Washer | W0254-F-041-064-SB |
| 25.400 (1.000") +0.18/+0.43 (mm) | 44.45 +/-0.25 | 1.59 +/-0.07 | Thrust Washer | W0254-F-044-016-SB |
| 25.400 (1.000") +0.18/+0.43 (mm) | 44.45 +/-0.25 | 3.18 +/-0.07 | Thrust Washer | W0254-F-044-032-SB |
| 25.400 (1.000") +0.28/+0.53 (mm) | 50.80 +/-0.25 | 3.18 +/-0.07 | Thrust Washer | W0254-F-051-032-SB |
| 25.400 (1.000") +0.28/+0.53 (mm) | 50.80 +/-0.25 | 4.76 +/-0.07 | Thrust Washer | W0254-F-051-048-SB |
| 25.400 (1.000") +0.27/+0.52 (mm) | 73.03 +/-0.25 | 3.18 +/-0.07 | Thrust Washer | W0254-F-073-032-SB |
| 26.988 (1.063") +/-0.13 (mm) | 60.33 +/-0.25 | 1.59 +/-0.07 | Thrust Washer | W0269-F-060-016-SB |
| 26.988 (1.063") +/-0.13 (mm) | 60.33 +/-0.25 | 3.18 +/-0.07 | Thrust Washer | W0269-F-060-032-SB |



Stocked or Short Delivery



Usually Available Short Delivery



Long delivery or not in current production

* Large Minimum Quantities

** Available only while stock lasts

Washers

| Nom. ID (d) mm (inches) | OD (D) mm | Thickness (T) mm | Other | Part Number |
|-------------------------------------|----------------------|------------------|---------------|----------------------|
| 28.575 (1.125") +0.25/+0.51 (mm) | 47.63 +/-0.25 | 3.18 +/-0.07 | Thrust Washer | W0285-F-048-032-SB |
| 28.575 (1.125") +0.25/+0.51 (mm) | 58.74 +/-0.25 | 3.18 +/-0.064 | Thrust Washer | W0285-F-059-032-SB |
| 31.750 (1.250") -0.05/+0.20 (mm) | 42.93 -0.19/+0.32 | 3.18 +/-0.07 | Thrust Washer | W0318-F-043-032-SB |
| 31.750 (1.250") -0.05/+0.20 (mm) | 42.93 -0.19/+0.32 | 3.18 +/-0.07 | Thrust Washer | W0318-F-043-032-SB1 |
| 31.750 (1.250") +0.25/+0.51 (mm) | 50.80 +/-0.25 | 1.59 +/-0.07 | Thrust Washer | W0318-F-051-016-SB |
| 31.750 (1.250") +0.25/+0.51 (mm) | 50.80 +/-0.25 | 3.18 +/-0.07 | Thrust Washer | W0318-F-051-032-SB |
| 31.750 (1.250") +0.25/+0.51 (mm) | 60.33 +/-0.25 | 1.59 +/-0.07 | Thrust Washer | W0318-F-060-016-SB |
| 31.750 (1.250") +0.25/+0.51 (mm) | 60.33 +/-0.25 | 3.18 +/-0.07 | Thrust Washer | W0318-F-060-032-SB |
| 31.750 (1.250") +0.00/+0.25 (mm) | 84.13 -0.27/+0.24 | 1.59 +/-0.07 | Thrust Washer | W0318-F-084-016-SB |
| 31.750 (1.250") +0.00/+0.25 (mm) | 84.13 -0.27/+0.24 | 3.18 +/-0.07 | Thrust Washer | W0318-F-084-032-SB |
| 34.925 (1.375") -0.15/+0.36 (mm) | 49.28 -0.19/+0.32 | 3.18 +/-0.07 | Thrust Washer | W0350-F-049-032-SB |
| 38.100 (1.500") -0.18/+0.33 (mm) | 50.80 +/-0.25 | 3.18 +/-0.07 | Thrust Washer | W0380-F-051-032-SB |
| 38.100 (1.500") -0.13/+0.38 (mm) | 63.63 -0.13/+0.38 | 3.18 +/-0.07 | Thrust Washer | W0380-F-064-032-SB |
| 38.100 (1.500") +0.00/+0.51 (mm) | 88.90 +/-0.25 | 4.76 +/-0.07 | Thrust Washer | W0380-F-089-048-SB |
| 40.000 (1.575") +0.14/+0.65 (mm) | 61.91 +/-0.38 | 3.18 +/-0.07 | Thrust Washer | W0400-F-062-032-SB |
| 44.450 (1.750") +0.32/+0.83 (mm) | 61.98 +/-0.38 | 3.18 +/-0.07 | Thrust Washer | W0445-F-062-032-SB |
| 44.450 (1.750") +0.58/+1.10 (mm) | 66.68 +/-0.38 | 3.18 +/-0.07 | Thrust Washer | W0445-F-067-032-SB |
| 49.213 (1.938") +0.58/+1.61 (mm) | 66.68 +/-0.38 | 3.18 +/-0.07 | Thrust Washer | * W0492-F-067-032-SB |
| 50.400 (1.984") +0.00/+0.51 (mm) | 76.20 +/-0.38 | 3.18 +/-0.07 | Thrust Washer | W0504-F-076-032-SB |
| 50.400 (1.984") +0.00/+0.51 (mm) | 76.20 +/-0.38 | 4.76 +/-0.07 | Thrust Washer | W0504-F-076-048-SB |
| 50.400 (1.984") +0.00/+0.51 (mm) | 76.20 +/-0.38 | 6.35 +/-0.07 | Thrust Washer | W0504-F-076-064-SB |
| 51.594 (2.031") +0.53/+1.04 (mm) | 92.08 +/-0.508 | 4.76 +/-0.07 | Thrust Washer | W0516-F-092-048-SB |
| 57.150 (2.250") -0.20/+0.30 (mm) | 88.90 +/-0.38 | 3.18 +/-0.064 | Thrust Washer | W0572-F-089-032-SB |
| 63.500 (2.500") -0.20/+0.30 (mm) | 82.55 +/-0.38 | 3.18 +/-0.07 | Thrust Washer | W0635-F-083-032-SB |
| 70.000 (2.756") +0.15/+0.66 (mm) | 98.43 +/-0.38 | 6.35 +/-0.07 | Thrust Washer | W0700-F-098-064-SB |



Stocked or Short Delivery



Usually Available Short Delivery



Long delivery or not in current production

* Large Minimum Quantities

** Available only while stock lasts

TIPS

Sintered bronze bushes are self lubricating until the oil impregnation dries. Sintered bronze bushes should be re-lubricated regularly.

Sintered bronze can usually be identified by it's speckled textured appearance.

Bushes have a relatively high load carrying capacity but a much lower speed capability compared with similar sized ball bearings.

TOLERANCES

A standard toleranced sintered bronze bush is considered to be oversized on both the bore and the outside diameter within the ranges shown below. Many special bushes are also available, falling outside this tolerance range. Please refer to the tolerances shown beneath the size for each specific bush in the catalogue.

Standard tolerance range for ID and OD:

| Nominal Size | Tolerance Range |
|------------------------------|---------------------|
| ≤ 38.1 mm | +0.025 to +0.051 mm |
| > 38.1 mm ≤ 63.5 mm | +0.038 to +0.076 mm |
| > 63.5 mm ≤ 88.9 mm | +0.051 to +0.102 mm |
| > 88.9 mm ≤ 114.3 mm | +0.064 to +0.127 mm |
| > 114.3 mm ≤ 139.7 mm | +0.089 to +0.178 mm |
| > 139.7 mm ≤ 165.1 mm | +0.102 to +0.204 mm |

Bushes with non standard tolerances are indicated by a suffix combination of L (Low), H (High), U (Undersized) and T (ID or OD Within Standard Tolerance whilst the other is not). Always refer to the actual tolerances listed below each item in the catalogue.



Distributed By

Miniature Bearings Australia
<http://www.minibearings.com.au>
sales@minibearings.com.au

Resellers: Please place your contact sticker over our details

Avoid verbal communication

We sell an extensive range of products with varying amounts of technical data. Please assist us to provide you with accurate information by placing your orders and enquiries online or by e-mail.

Sintered Bronze